

Note that all unique customer requirements (i.e tolerance) need to be verified thru Alfa Laval.

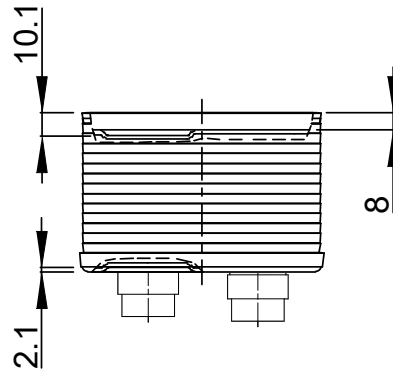
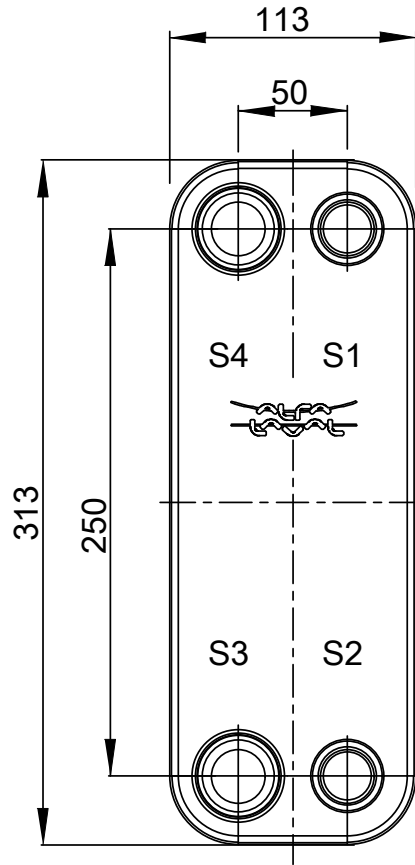
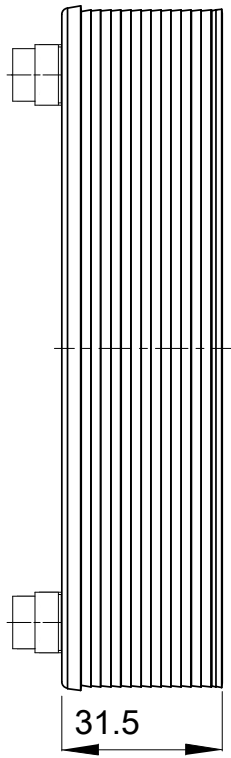
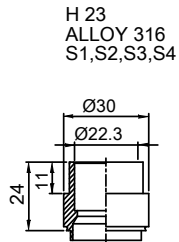

LÄMPÖPINTA-ALA m<sup>2</sup>  
 NETTOPAINO 2.2 kg  
 VEDELLÄ TÄYTETTYNÄ kg  
 LEVYMATERIAALI ALLOY 316  
 LEVYJÄRJESTYS 1\*3H/1\*4H

T1 T2 T3 T4 locations on back side correspond to S1 S2 S3 S4 on front side

KAIKKI MITAT MM:INÄ

PUOLI	AINEET	SISÄÄN	LÄMPÖT.	ULOS	LÄMPÖT.	VIRTAUSMÄÄRÄ	PAINEHÄVIÖ	NESTETILAV.
1	Water	S1	°C	S2	°C	kg/h	kPa	0.2 dm <sup>3</sup>
2	Water	S3	°C	S4	°C	kg/h	kPa	0.2 dm <sup>3</sup>

PRESSURE VESSEL APPROVAL

PED

CB30-8H (3075058483)

www.alfalaval.com

ASIAKAS / VIITE

PITUUS, mm 55 mm  
 LEVEYS, mm 113 mm  
 KORKEUS, mm 313 mm

YRITYS / VIITE  
 Oy Combi Cool Ab

26.11.2020  
 REV 0