



REFRIGERATION AND
AIR CONDITIONING

Instructions Protocol interface AK-PI 200



080R9263



RI8LU102

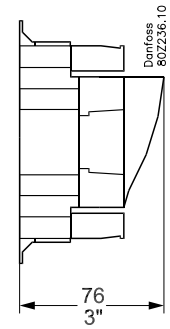
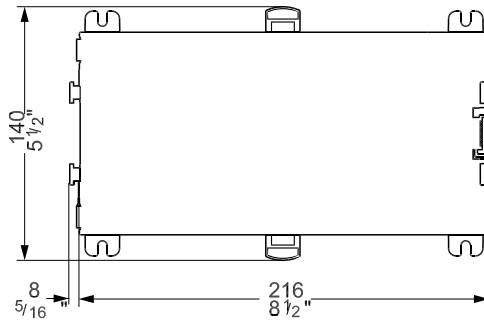
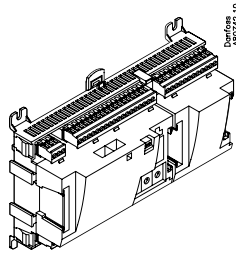

CE

-20° < t_{amb} < 55°C
-0°F < t_{amb} < 130°F
0 - 95% RH, non condensing
IP10 / VBG4
UL: E166834

AK-PI 200 installation:

See manual: RS8EX

Data communication:

See literature : RC8AC

Princip

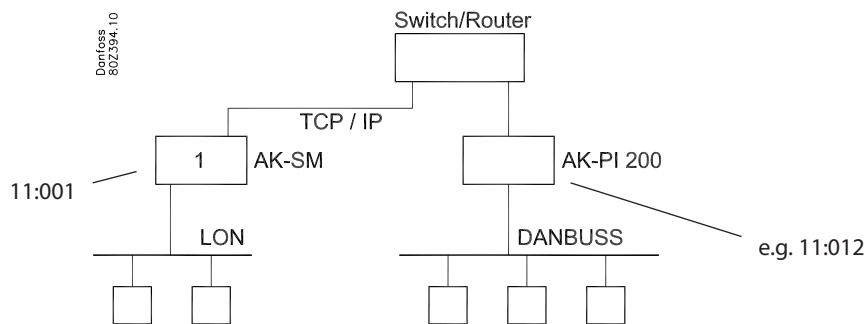

Supply voltage:

Transformer
Class II 

The 24V must not be shared by other controllers or units

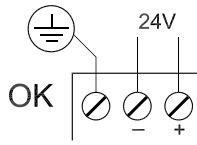

The 24 V input must not have earth connection

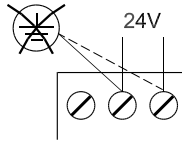

Danfoss
80Z206.11

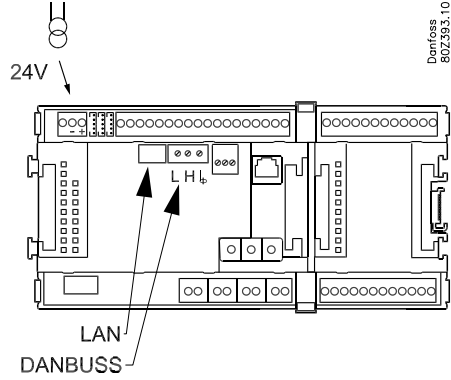

Danfoss
80Z393.10

Address

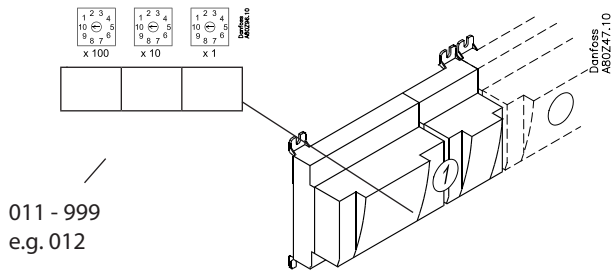

Danfoss
80Z47.10

 The Product contains electrical components
And may not be disposed together with domestic waste.
Equipment must be separate collected with Electrical and Electronic waste. According to Local and currently valid legislation.