



SERVICE MANUAL

VRF INVERTER MULTI-SYSTEM AIR-CONDITIONERS

(OUTDOOR UNIT)

KXZ series (Heat pump type)

FDC224KXZME1, 280KXZME1, 335KXZME1

• Note:

(1) Regarding the indoor unit series, refer to the No.'17 • KX-T-266 and '18 • KX-T-281.

CONTENTS

1. OUTLINE OF OPERATION CONTROL BY MICROCOMPUTER.....	2
1.1 Remote control (Option parts).....	2
1.2 Operation control function by the wired remote control.....	5
1.3 Operation control function by the indoor control	10
1.4 Operation control function by the outdoor control	25
2. SYSTEM TROUBLESHOOTING PROCEDURE	62
2.1 Basics of troubleshooting	62
2.2 Explanation of troubleshooting	63
2.3 Contents of troubleshooting	64
2.4 Outdoor unit control PCB replacement procedure	117
2.5 Inverter PCB replacement procedure	119
3. ELECTRICAL WIRING	123
4. PIPING SYSTEM.....	125
5. APPLICATION DATA	127
6. OUTDOOR UNIT DISASSEMBLY PROCEDURE	150
7. INDOOR UNIT DISASSEMBLY PROCEDURE	152

1. OUTLINE OF OPERATION CONTROL BY MICROCOMPUTER

1.1 Remote control (Option parts)

(1) Wired remote control

(a) Model RC-EX3A

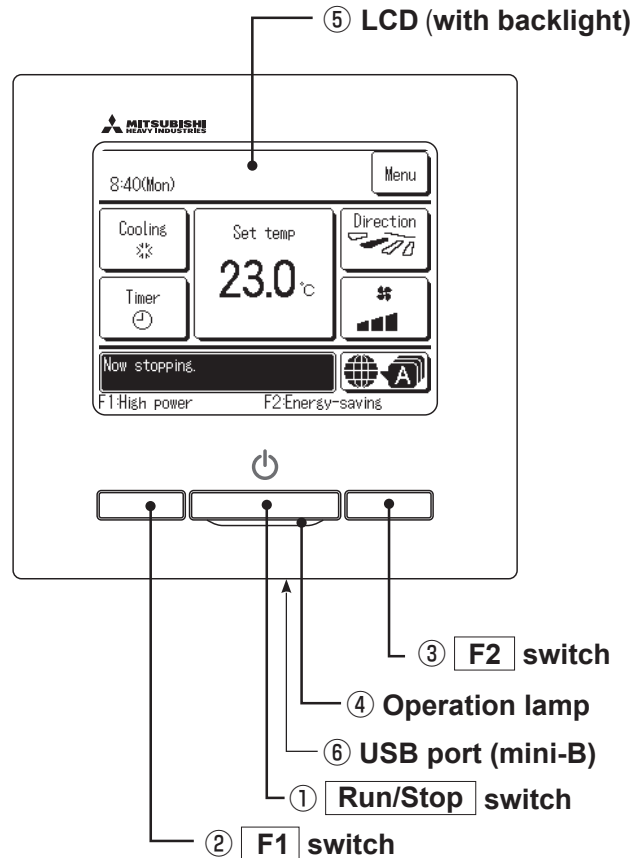

Touch panel system, which is operated by tapping the LCD screen with a finger, is employed for any operations other than the ①Run/Stop, ②F1 and ③F2 switches.

① Run/Stop switch

One push on the button starts operation and another push stops operation.

If the backlight is ON setting, when the screen is tapped while the backlight is turned off, the backlight only is turned on. (Operations with switches ①, ② and ③ are excluded.)

② F1 switch ③ F2 switch

This switch starts operation that is set in F1/F2 function setting.

⑥ USB port

USB connector (mini-B) allows connecting to a personal computer.

④ Operation lamp

This lamp lights in green (yellow-green) during operation. It changes to red (orange) if any error occurs.

For operating methods, refer to the instruction manual attached to the software for personal computer (remote control utility software).

Operation lamp luminance can be changed.

Note(1) When connecting to a personal computer, do not connect simultaneously with other USB devices. Please be sure to connect to the computer directly, without going through a hub, etc.

⑤ LCD (with backlight)

A tap on the LCD lights the backlight.

The backlight turns off automatically if there is no operation for certain period of time. Lighting period of the backlight lighting can be changed.

(b) Model RC-E5

The figure below shows the remote control with the cover opened. Note that all the items that may be displayed in the liquid crystal display area are shown in the figure for the sake of explanation. Characters displayed with dots in the liquid crystal display area are abbreviated.

The figure below shows the remote control with the cover opened.

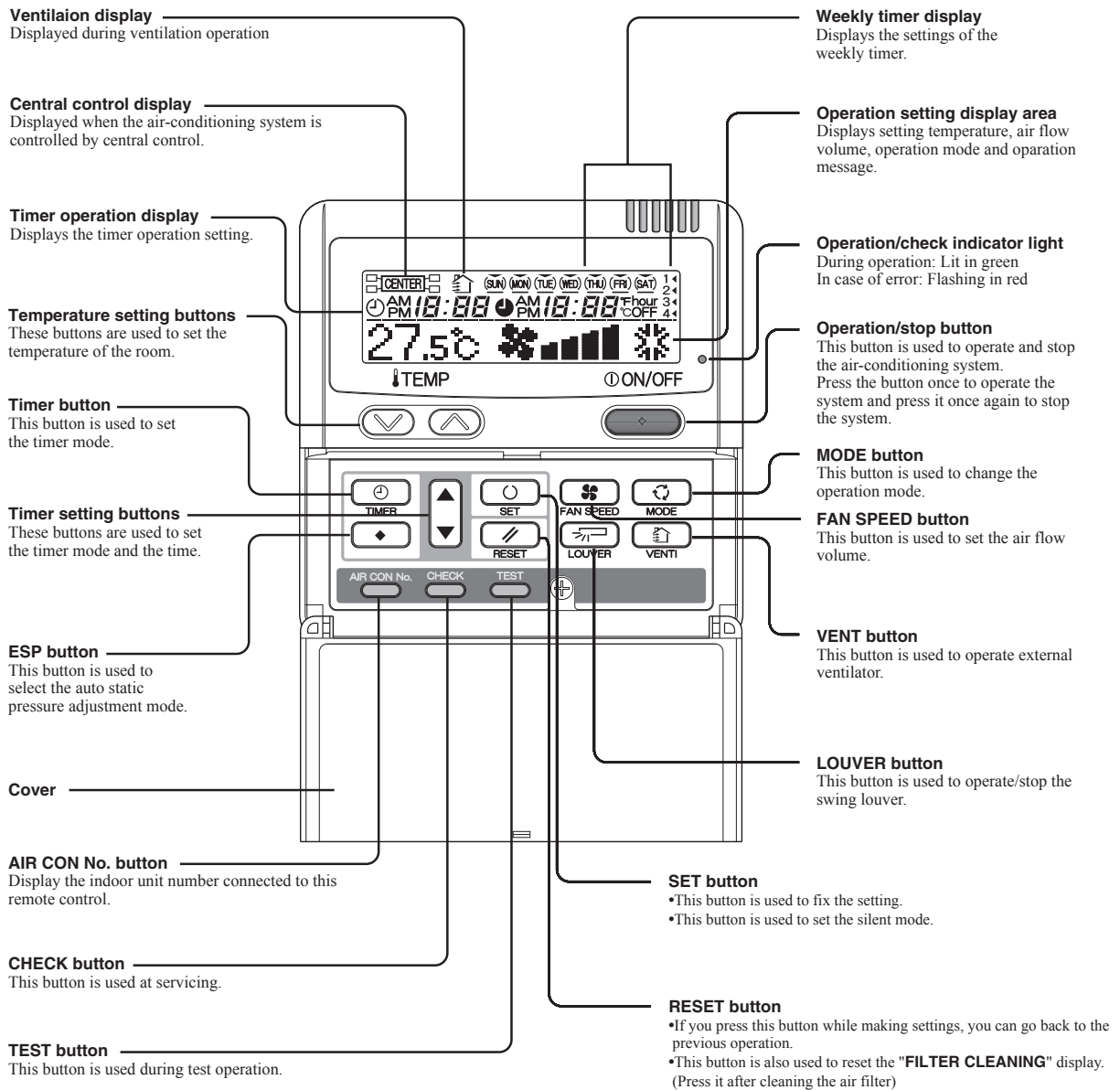

* All displays are described in the liquid crystal display for explanation.

(2) Wireless remote control

Model RCN-E2

Indication section

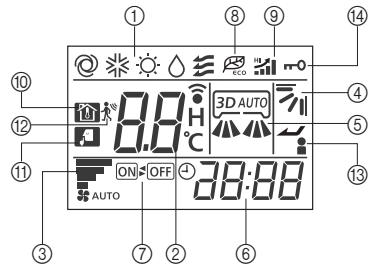

①	OPERATION MODE display SET TEMP display	Indicates selected operation mode. Indicates set temperature.
②	SLEEP TIMER time display Indoor function setting number display	Indicates the amount of time remaining on the sleep timer. Indicates the setting number of the indoor function setting.
③	FAN SPEED display	Indicates the selected air flow volume.
④	UP/DOWN AIR FLOW display	Indicates the up/down louver position.
⑤	LEFT/RIGHT AIR FLOW display	Indicates the left/right louver position.
⑥	Clock display	Indicates the current time. If the timer is set, the ON TIMER and OFF TIMER setting times are indicated.
⑦	ON/OFF TIMER display	Displayed when the timer is set.
⑧	ECO mode display	Displayed when the energy-saving operation is active.
⑨	HI POWER display	Displayed when the high power operation is active.
⑩	NIGHT SETBACK display	Displayed when the home leave mode is active.
⑪	SILENT display	Displayed when the silent mode control is active.
⑫	Motion sensor display	Displayed when the infrared sensor control(motion sensor control) is enabled.
⑬	Anti draft setting display	Displayed when anti draft setting is enabled.
⑭	Child lock display	Displayed when child lock is enabled.

Operation section

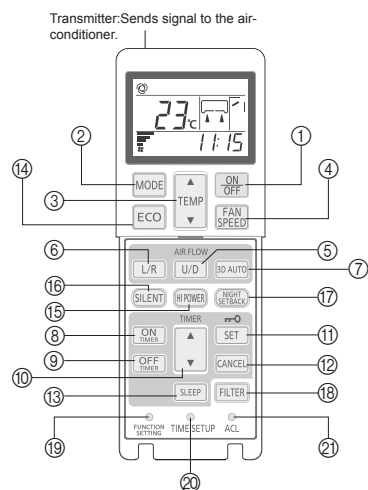

①	ON/OFF button	When this is pressed once, the air-conditioner starts to operate and when this is pressed once again, it stops operating.
②	MODE button	Every time this button is pressed, displays switch as below
③	TEMP button	Change the set temperature by pressing ▲ or ▼ button.
④	FAN SPEED button	The fan speed is switched in the following order: 1-speed → 2-speed → 3-speed → 4-speed → AUTO → 1-speed.
⑤	U/D button	Used to determine the up/down louver position.
⑥	L/R button	Used to determine the left/right louver position.
⑦	3D AUTO button	Used to switch whether or not to enable or disable 3D AUTO mode.
⑧	ON TIMER button	Used to set the ON TIMER.
⑨	OFF TIMER button	Used to set the OFF TIMER.
⑩	SELECT button	Used to switch the time when setting the timer or adjusting the time. Used to switch the settings of the indoor function.
⑪	SET button	Used to determine the setting when setting the timer or adjusting the time. Used to determine the settings of the indoor function. When press and hold SET button ,Child Lock is enabled.
⑫	CANCEL button	Used to cancel the timer setting.
⑬	SLEEP button	Used to set the sleep timer.
⑭	ECO button	Pressing this button starts the energy-saving operation. Pressing this button again cancels it.
⑮	HI POWER button	Pressing this button starts the high power operation. Pressing this button again cancels it.
⑯	SILENT button	Pressing this button starts the silent mode control. Pressing this button again cancels it.
⑰	NIGHT SETBACK button	Pressing this button starts the home leave mode. Pressing this button again cancels it.
⑱	FILTER button	Pressing this button resets FILTER SIGN.
⑲	FUNCTION SETTING switch	Used to set the indoor function.
⑳	TIME SETUP switch	Used to set the current time.
㉑	ACL switch	Used to reset the microcomputer.

1.2 Operation control function by the wired remote control

(1) Model RC-EX3A

(a) Switching sequence of the operation mode switches of remote control

- (i) Tap the change operation mode button on the TOP screen.
- (ii) When the change operation mode screen is displayed, tap the button of desired mode.
- (iii) When the operation mode is selected, the display returns to the TOP screen.

Icons displayed have the following meanings.

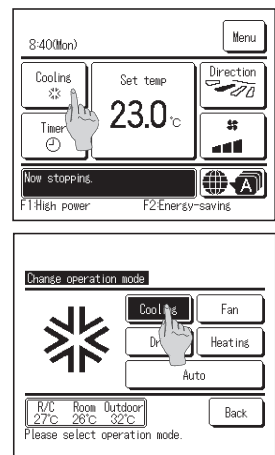
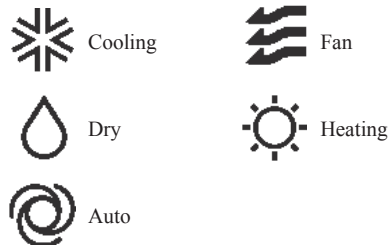

Notes(1) Operation modes which cannot be selected depending on combinations of indoor unit and outdoor unit are not displayed.

- (2) When the Auto is selected, the cooling and heating switching operation is performed automatically according to indoor and outdoor temperatures.

(b) CPU reset

Reset CPU from the remote control as follows.

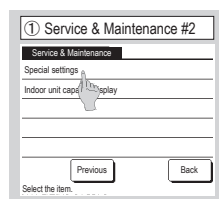
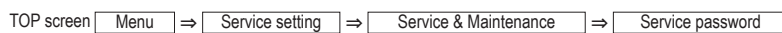

The selected screen is displayed.

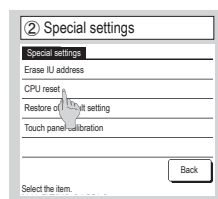

The selected screen is displayed.

CPU reset

Microcomputers of indoor unit and outdoor unit connected are reset (State of restoration after power failure).

(c) Power failure compensation function (Electric power source failure)

Enable the Auto-restart function from the remote control as follows.

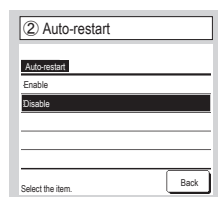
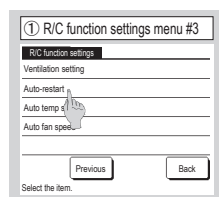
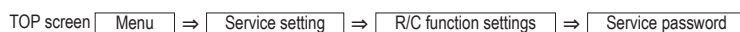

If the unit stops during operation,

Enable

It returns to the state before the power failure as soon as the power source is restored (After the end of the primary control at the power on).

Disable

It stops after the restoration of power source.

- Since the status of remote control is retained in memory always, it restarts operations according to the contents of memory as soon as the power source is restored. Although the timer mode is cancelled, the weekly timer, peak cut timer and silent mode timer operate according to the following contents:

- When the clock setting is valid : These timer settings are also valid.
- When the clock setting is invalid : These timer settings become “Invalid” since the clock setting is invalid. These timer settings have to be changed to “Valid” after the timer setting.

●Content memorized with the power failure compensation are as follows.

Note(1) Items f) and g) are memorized regardless whether the power failure compensation is effective or not while the setting of silent mode is cancelled regardless whether the power failure compensation is effective or not.

- a) At power failure – Operating/stopped
If it had been operating under the off timer mode, sleep timer mode, the state of stop is memorized.
- b) Operation mode
- c) Air flow volume mode
- d) Room temperature setting
- e) Louver auto swing/stop
However, the stop position (4-position) is cancelled so that it returns to Position (1).
- f) “Remote control function items” which have been set with the administrator or installation function settings
 (“Indoor function items” are saved in the memory of indoor unit.)
- g) Weekly timer, peak-cut timer or silent mode timer settings
- h) Remote control function setting

(d) Alert displays

If the following a) to c) appear, check and repair as follows.

- a) Communication check between indoor unit and remote control

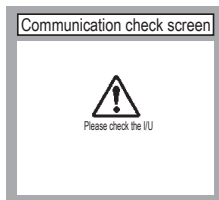

- This appears if communications cannot be established between the remote control and the indoor unit.
Check whether the system is correctly connected (indoor unit, outdoor unit, remote control) and whether the power source for the outdoor unit is connected.

- b) Clock setting check

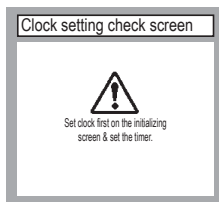

- This appears when the timer settings are done without clock setting.
Set the clock setting before the timer settings.

- c) Misconnection

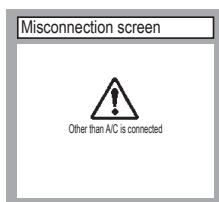

- This appears when something other than the air-conditioner has been connected to the remote control.
Check the location to which the remote control is connected.

(2) Model RC-E5

(a) Switching sequence of the operation mode switches of remote control



(b) CPU reset

This functions when “CHECK” and “ESP” buttons on the remote control are pressed simultaneously. Operation is same as that of the power source reset.

(c) Power failure compensation function (Electric power source failure)

- This becomes effective if “Power failure compensation effective” is selected with the setting of remote control function.
- Since it memorizes always the condition of remote control, it starts operation according to the contents of memory no sooner than normal state is recovered after the power failure. Although the auto swing stop position and the timer mode are cancelled, the weekly timer setting is restored with the holiday setting for all weekdays. After recovering from the power failure, it readjusts the clock and resets the holiday setting for each weekday so that the setting of weekly timer becomes effective.

- Content memorized with the power failure compensation are as follows.

Note (1) Items f), g) and h) are memorized regardless whether the power failure compensation is effective or not while the setting of silent mode is cancelled regardless whether the power failure compensation is effective or not.

- a) At power failure – Operating/stopped

If it had been operating under the off timer mode, sleep timer mode, the state of stop is memorized.

(Although the timer mode is cancelled at the recovery from power failure, the setting of weekly timer is changed to the holiday setting for all weekdays.)

- b) Operation mode
- c) Air flow volume mode
- d) Room temperature setting
- e) Louver auto swing/stop

However, the stop position (4-position) is cancelled so that it returns to Position (1).

- f) “Remote control function items” which have been set with the remote control function setting (“Indoor function items” are saved in the memory of indoor unit.)
- g) Upper limit value and lower limit value which have been set with the temperature setting control
- h) Sleep timer and weekly timer settings (Other timer settings are not memorized.)

[Parts layout on remote control PCB]

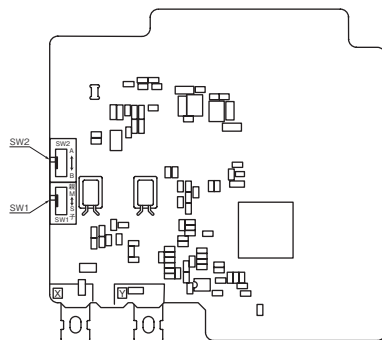

Master/ slave setting when more than one remote controls are used

A maximum of two remote controls can be connected to one indoor unit (or one group of indoor units.)

Switch	Setting	Content
SW1	M	Master remote control
	S	Slave remote control

Note (1) Don't change SW2 because it is not used normally.

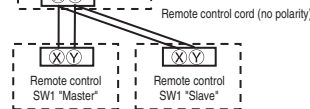

Caution

When using multiple remote controls, the following displays or settings cannot be done with the slave remote control. It is available only with the master remote control.

- ① Louver position setting (set upper or lower limit of swinging range)
- ② Setting indoor unit functions
- ③ Setting temperature range
- ④ Operation data display
- ⑤ Error data display
- ⑥ Silent mode setting
- ⑦ Test operation of drain pump
- ⑧ Remote control sensor setting

(3) Operation and setting from wired remote control

A : Refer to the instruction manual for RC-EX series
 B : Refer to the installation manual for RC-EX series
 C : Loading a utility software via Internet

○ : Nearly same function setting and operations are possible.
 △ : Similar function setting and operations are possible.

Setting & display item	Description	RC-EK3A	RC-E5	
1.Remote control network				
1 Control plural indoor units by a single remote control	A remote control can control plural indoor units up to 16 (in one group of remote control network). An address is set to each indoor unit.		○	
2 Main/sub setting of remote controls	A pair of remote controls (including optional wireless remote control) can be connected within the remote control network. Set one to "Main" and the other to "Sub".	B	○	
2.TOP screen, Switch manipulation				
1 Menu	"Control", "State", or "Details" can be selected. (3-8)	A		
2 Operation mode	"Cooling", "Heating", "Fan", "Dry" or "Auto" can be set.	A	○	
3 Set temp.	"Set temperature" can be set by 0.5°C interval.	A	○	
4 Air flow direction	"Air flow direction" (Individual flap control) can be set. Select Enable or Disable for the "3D AUTO" (in case of FDK). *1	A	△	
5 Fan speed	"Fan speed" can be set.	A	○	
6 Timer setting	"Timer operation" can be set.	A	○	
7 ON/OFF	"On/Off operation of the system" can be done.	A	○	
8 F1 SW	The system operates and is controlled according to the function specified to the F1 switch.	A		
9 F2 SW	The system operates and is controlled according to the function specified to the F2 switch.	A		
3.Useful functions				
1 Individual flap control	The moving range (the positions of upper limit and lower limit) of the flap for individual flap can be set. Set also the left and right limit positions for FDK.	A	△	
2 Anti draft setting When the panel with the anti-draft function is assembled.	When the panel with the anti draft function is assembled, select to Enable or Disable the anti draft setting for each operation mode and for each blow outlet.	A		
3 Timer settings	Set On timer by hour	The period of time to start operation after stopping can be set. • The period of set time can be set within range of 1hour-12hours (1hr interval). • The operation mode, set temp. and fan speed at starting operation can be set.	A	△
	Set Off timer by hour	The period of time to stop operation after starting can be set. • The period of set time can be set within range of 1hour-12hours (1hr interval).	A	△
	Set On timer by clock	The clock time to start operation can be set. • The set clock time can be set by 5 minutes interval. • [Once (one time only)] or [Everyday] operation can be switched. • The operation mode, set temp. and fan speed at starting operation can be set.	A	△
	Set Off timer by clock	The clock time to stop operation can be set. • The set clock time can be set by 5 minutes interval. • [Once (one time only)] or [Everyday] operation can be switched.	A	△
	Confirmation of timer settings	Status of timer settings can be seen.	A	
4 Favorite setting [Administrator password]	Set the operation mode, setting temperature, air flow capacity and air flow direction for the choice setting operations. Set them for the Favorite set 1 and the Favorite set 2 respectively.	A		
5 Weekly timer	On timer and Off timer on weekly basis can be set. • 8-operation patterns per day can be set at a maximum. • The setting clock time can be set by 5 minutes interval. • Holiday setting is available. • The operation mode, set temp. and fan speed at starting operation can be set.	A	△	
6 Home leave mode [Administrator password]	When leaving home for a long period like a vacation leave, the unit can be operated to maintain the room temperature not to be hotter in summer or not to be colder in winter. • The judgment to switch the operation mode (Cooling ⇄ Heating) is done by the both factors of the set temp. and outdoor air temp. • The set temp. and fan speed can be set.	A		
7 External Ventilation When the ventilator is combined.	On/Off operation of the external ventilator can be done. It is necessary to set from [Menu] ⇒ [Service setting] ⇒ [R/C function settings] ⇒ [Ventilation setting]. • If the "Independent" is selected for the ventilation setting, the ventilator can be operated or stopped.	A	○	
8 Select the language	Select the language to display on the remote control. • Select from English, German, French, Spanish, Italian, Dutch, Turkish, Portuguese, Russian, Polish, Japanese and Chinese.	A		
4.Energy-saving setting				
Administrator password				
1 Sleep timer	To prevent the timer from keeping ON, set hours to stop operation automatically with this timer. • The selectable range of setting time is from 30 to 240 minutes. (10 minutes interval) • When setting is "Enable", this timer will activate whenever the ON timer is set.	A	△	
2 Peak-cut timer	Power consumption can be reduced by restructuring the maximum capacity. Set the [Start time], the [End time] and the capacity limit % (Peak-cut %). • 4-operation patterns per day can be set at maximum. • The setting time can be changed by 5-minutes interval. • The selectable range of capacity limit % (Peak-cut %) is from 0% to 40-80% (20% interval) • Holiday setting is available.	A		
3 Automatic temp. set back	After the elapse of the set time period, the current set temp. will be set back to the [Set back time.] • The setting can be done in cooling and heating mode respectively. • Selectable range of the set time is from 20 min. to 120 min. (10 min. interval). • Set the [Set back temp.] by 1°C interval.	A	△	
4 Infrared sensor control (Motion sensor control) When the panel with the infrared sensor (motion sensor) is assembled.	When the infrared sensor (motion sensor) is used, it is necessary to set Enable or Disable for the "Power control" and the "Auto-off".	A		
5.Filter				
1 Filter sign reset	Filter sign reset	A		
	Setting next cleaning date	A		
6.User setting				
1 Internal settings	Clock setting	The current date and time can be set or revised. • If a power failure continues no longer than 80 hours, the clock continues to tick by the built-in power source.	A	△
	Date and time display	[Display] or [Hide] the date and/or time can be set, and [12H] or [24H] display can be set.	A	
	Summer time	When select [Enable], the +1hour adjustment of current time can be set. When select [Disable], the [Summer time] adjustment can be reset.	A	
	Contrast	The contrast of LCD can be adjusted higher or lower.	A	
	Backlight	Switching on/off a light can be set and period of the lighting time can be set within the range of 5sec-90 sec (5sec interval).	A	
	Control sound	It can set with or without [Control sound (beep sound)] at touch panel.	A	
	Operation lamp luminance	This is used to adjust the luminance of operation lamp.	A	
2 Administrator settings [Administrator password]	Permission/Prohibition setting	• Permission/Prohibition setting of operation can be set. [On/Off] [Change set temp] [Change operation mode] [Change flap direction] [Change fan speed] [High power operation] [Energy-saving operation] [Timer] Request for administrator can be set. [Individual flap control] [Weekly timer] [Select the language] [Anti draft setting]	A	△
	Outdoor unit silent mode timer	The period of time to operate the outdoor unit by prioritizing the quietness can be set. • The [Start time] and the [End time] for operating outdoor unit in silent mode can be set. • The period of the operation time can be set once a day by 5 minutes interval.	A	△
	Setting temp. range	The upper/lower limit of temp. setting range can be set. • The limitation of indoor temp. setting range can be set for each operation mode in cooling and heating.	A	△
	Temp. increment setting	The temp. increment setting can be changed by 0.5°C or 1.0°C.	A	
	Set temp. display	Ways of displaying setting temperatures can be selected.	A	

Setting & display item		Description	RC-EX3A	RC-E5	
2 Administrator settings [Administrator password]	R/C display setting	Register [Room name] [Name of I/U] Display [Indoor temp. display] or not. Display [Error code display] or not. Display [Heating stand-by display] [Defrost operation display] [Auto cooling/heating display] [Display temp. of R/C, Room, Outdoor] or not.	A	△	
	Change administrator password	The administrator password can be changed. (Default setting is "0000") The administrator password can be reset.	A B		
	F1/F2 function setting	Functions can be set for F1 and F2. Selectable functions: [High power operation], [Energy-saving operation], [Silent mode cont.], [Home leave mode], [Favorite set 1], [Favorite set 2] and [Filter sign reset].	A		
7. Service setting					
1 Installer settings [Service password]	Installation date	The [Installation date] can be registered. • When registering the [Installation date], the [Next service date] is displayed automatically. (For changing the [Next service date], please refer the item of [Service & Maintenance])	B		
	Company information	The [Company information] can be registered and can be displayed on the R/C. • The [Company] can be registered within 26 characters. • The [Phone No.] can be registered within 13 digits.	B		
	Test run	On/Off operation of the test run can be done.			
	Cooling test run	The [Cooling test run] can be done at 5°C of set temp. for 30 minutes.	B	○	
	Drain pump test run	Only drain pump can be operated.			
	Static pressure adjustment	In case of combination with only the ducted indoor unit which has a function of static pressure adjustment, the static pressure is adjustable. • It can be set for each indoor unit individually.	B		
	Change auto-address	The set address of each indoor unit decided by auto-address setting method can be changed to any other address. (For multiple KX units only)	B	△	
	Address setting of main IU	Main indoor unit address can be set. • Only the Main indoor unit can change operation mode and the Sub indoor units dominated by the Main indoor shall follow. • The Main indoor unit can domain 10 indoor units at a maximum.	B	△	
	IU back-up function	When a pair of indoor units (2 groups) is connected to one unit of remote control, it can be set Enable or Disable for the [IU rotation], [IU capacity back-up] and [IU fault back-up]	B		
	Infrared sensor setting (Motion sensor setting) When the panel with the infrared sensor (motion sensor) is assembled.	Set Enable or Disable for the infrared sensor detectors of indoor units connected to the remote control. If Disable is selected, it cannot be control the infrared sensor control for the energy-saving setting.	B		
2 R/C function setting [Service password]	Main/Sub R/C	The R/C setting of [Main/Sub] can be changed.	B	○	
	Return air temp.	When two or more indoor units are connected to one unit of remote control, suction sensors, which are used for the judgement by thermostat, can be selected. • It can be selected from [Individual], [Master IU] and [Average temp.].	B		
	R/C sensor	It can be set the mode to switch to the remote control sensor. It can be selected from cooling and heating.	B	△	
	R/C sensor adjustment	The offset value of [R/C sensor] sensing temp. can be set respectively in heating and cooling.	B	△	
	Operation mode °C / °F	Enable or Disable can be set for each operation mode. Set the unit for setting temperatures. • °C or °F can be selected.	B	△	
	Fan speed	Fan speeds can be selected.	B	○	
	External input	When two or more indoor units are connected to one unit of remote control, the range to apply CnT inputs can be set.	B	○	
	Upper/lower flap control	[Stop at fixed position] or [Stop at any position] can be selected for the upper and lower louvers.	B	○	
	Left/right flap control	[Fixed position stop] or [Stop at any position] can be selected for the right and left louvers.	B	○	
	Ventilation setting	Combination control for ventilator can be set.	B	○	
	Auto-restart	The operation control method after recovery of power failure happened during operation can be set.	B	○	
	Auto temp. setting	[Enable] or [Disable] of [Auto temp. setting] can be selected.	B		
	Auto fan speed	[Enable] or [Disable] of [Auto fan speed] can be selected.	B		
	3 IU settings [Service password]	Fan speed setting	The fan speed for indoor units can be set.	B	○
		Filter sign	The setting of filter sign display timer can be done following patterns.	B	○
External input 1		The connect of control by external input 1 can be changed.	B	○	
External input 1 signal		The type of external input 1 signal can be changed.	B	○	
External input 2		The connect of control by external input 2 can be changed.	B		
External input 2 signal		The type of external input 2 signal can be changed.	B		
Heating thermo-OFF temp. adjustment		The judgement temp. of heating thermo-off can be adjusted within the range from 0 to +3°C (1°C interval)	B	△	
Return temperature adjustment		The sensing temp. of return air temp. sensor built in the indoor unit can be adjusted within the range of ±2°C.	B	△	
Fan control in cooling thermo-OFF		Fan control, when the cooling thermostat is turned OFF, can be changed.	B	○	
Fan control in heating thermo-OFF		Fan control, when the heating thermostat is turned OFF, can be changed.	B	○	
Anti-frost temp.		Judgment temperature for the anti-frost control during cooling can be changed.	B	○	
Anti-frost control		When the anti-frost control of indoor unit in cooling is activated, the fan speed can be changed.	B	○	
Drain pump operation		In any operation mode in addition to cooling and dry mode, the setting of drain pump operation can be done.	B	○	
Keep fan operating after cooling is stopped		The time period residual fan operation after stopping or thermo-off in cooling mode can be set.	B	○	
Keep fan operating after heating is stopped		The time period residual fan operation after stopping or thermo-off in heating mode can be set.	B	○	
Intermittent fan operation in heating		The fan operation rule following the residual fan operation after stopping or thermo-off in heating mode can be set.	B	○	
Fan circulator operation		In case that the fan is operated as the circulator, the fan control rule can be set.	B		
Control pressure adjust		When only the OA processing units are operated, control pressure value can be changed.	B		
Auto operation mode		The [Auto rule selection] for switching the operation mode automatically can be selected from 3 patterns.	B		
Thermo. rule setting		When selecting [Outdoor air temp. control], the judgment temp. can be offset by outdoor temp..	B		
Auto fan speed control	Auto switching range for the auto fan speed control can be set.	B			
IU overload alarm	If the difference between the setting temperature and the suction temperature becomes larger than the temperature difference set for the overload alarm, at 30 minutes after the start of operation, the overload alarm signal is transmitted from the external output (CnT-5).	B			
4 Service & Maintenance [Service password]	External output setting	Functions assigned to the external outputs 1 to 4 can be changed.	B		
	IU address	Max 16 indoor units can be connected to one remote control, and all address No. of the connected indoor units can be displayed. • The indoor unit conforming to the address No. can be identified by selecting the address No. and tapping [Check] to operate the indoor fan.	B	○	
	Next service date	The [Next service date] can be registered. • The [Next service date] and [Company information] is displayed on the message screen.	A B	○	
	Operation data	The [Operation data] for indoor unit and outdoor unit can be displayed.	B	○	
	Error display	Error history	The error history can be displayed.	B	△
		Display anomaly data	The operation data just before the latest error stop can be displayed.		
		Erase anomaly data	Anomaly operation data can be erased.		
		Reset periodical check	The timer for the periodical check can be reset.		
	Saving IU settings	The IU settings memorized in the indoor PCB connected to the remote control can be saved in the memory of the remote control.	B		
	Special settings	[Erase IU address] [CPU reset] [Restore of default setting] [Touch panel calibration]	B	△	
Indoor unit capacity display	Address No. and capacities of indoor units connected to the remote control are displayed.	B			
8. Contact company					
9. Inspection					
Confirmation of Inspection		This is displayed when any error occurs.	A	△	
10. PC connection					
USB connection		Weekly timer setting and etc., can be set from PC.	C		

◆ Listed items may not function depending on the specifications of indoor and outdoor units which are combined.

1.3 Operation control function by the indoor control

(1) Operations of functional items during cooling/heating

Operation Functional item	Cooling		Fan	Heating			Dehumidifying
	Thermostat ON	Thermostat OFF		Thermostat ON	Thermostat OFF	Hot start (Defrost)	
Compressor	○	×	×	○	×	○	○/×
4-way valve	×	×	×	○	○	○(×)	×
Outdoor unit fan	○	×	×	○	×	○(×)	○/×
Indoor unit fan	○	○	○	○/×	○/×	○/×	○/×
Drain pump ⁽³⁾	○	× ⁽²⁾	× ⁽²⁾	○/× ⁽²⁾			Thermostat ON:○ Thermostat OFF:× ⁽³⁾

Notes (1) ○: Operation ×: Stop ○/×: Turned ON/OFF by the control other than the room temperature control.

(2) ON during the drain motor delay control.

(3) Drain pump ON setting may be selected with the indoor unit function setting of the wired remote control.

(2) Dehumidifying (DRY) operation

Indoor ambient temperatures and humidity are controlled simultaneously with the relative humidity sensor (HS) and the suction temperature sensor [Thi-A (or the remote control sensor when it is activated)], which are installed at the suction inlet.

- When the operation has been started with cooling, if there is a difference of 2°C or less between the suction and setting temperatures, the tap of indoor fan is lowered by one tap. This tap is retained for 3 minutes after changing the tap.
- After the above condition, when a difference between suction and setting temperature is lower than 3°C, and the relative humidity is high, the tap of indoor unit fan is lowered by one tap.

When the difference between suction and setting temperature is larger than 3°C, the fan of indoor unit fan is raised by one tap. This tap is retained for 3 minutes after changing the tap.

- When relative humidity becomes lower, the indoor unit fan tap is retained.
- In case of the thermostat OFF, the indoor unit fan tap at the thermostat ON is retained.

(3) Timer operation

(a) RC-EX3A

(i) Sleep timer

Set the time from the start to stop of operation. The time can be selected in the range from 30 to 240 minutes (in the unit of 10-minute).

Note (1) Enable the "Sleep timer" setting from the remote control. If the setting is enabled, the timer operates at every time.

(ii) Set OFF timer by hour

Set the time to stop the unit after operation, in the range from 1 to 12 hours (in the unit of hour).

(iii) Set ON timer by hour

Set the time to start the unit after the stop of operation, in the range from 1 to 12 hours (in the unit of hour). It is allowed also to set simultaneously the indoor temperature, operation mode, air flow rate and warm-up enabled/disabled.

(iv) Set ON timer by clock

Set the time to start operation. The time can be set in the unit of 5-minute. This setting can be activated only once or at every time. It is allowed also to set simultaneously the indoor temperature, operation mode, air flow rate and warm-up enabled/disabled.

Note (1) It is necessary to set the clock to use this timer.

(v) Set OFF timer by clock

Set the time to stop operation. The time can be set in the unit of 5-minute. This setting can be activated only once or at every time.

Note (1) It is necessary to set the clock to use this timer.

(vi) Weekly timer

Set the ON or OFF timer for a week. Up to 8 patterns can be set for a day. The day-off setting is provided for holidays and non-business days.

Note (1) It is necessary to set the clock to use the weekly timer.

(vii) **Combination of patterns which can be set for the timer operations**

	Sleep time	Set OFF timer by hour	Set ON timer by hour	Set OFF timer by clock	Set ON timer by clock	Weekly timer
Sleep time		×	×	○	○	○
Set OFF timer by hour	×		×	×	×	×
Set ON timer by hour	×	×		×	×	×
Set OFF timer by clock	○	×	×		○	×
Set ON timer by clock	○	×	×	○		×
Weekly timer	○	×	×	×	×	

Note (1) ○: Allowed ×: Not

(b) RC-E5

(i) Sleep timer

Set the duration of time from the present to the time to turn off the air-conditioner.

It can be selected from 10 steps in the range from “OFF 1 hour later” to “OFF 10 hours later”. After the sleep timer setting, the remaining time is displayed with progress of time in the unit of hour.

(ii) OFF timer

Time to turn OFF the air-conditioner can be set in the unit of 10 minutes.

(iii) ON timer

Time to turn ON the air-conditioner can be set. Indoor temperature can be set simultaneously.

(iv) Weekly timer

Timer operation (ON timer, OFF timer) can be set up to 4 times a day for each weekday.

(v) Timer operations which can be set in combination

Item	Item	Timer	OFF timer	ON timer	Weekly timer
Timer			×	○	×
OFF timer	×			○	×
ON timer	○	○	○		×
Weekly timer	×	×	×	×	

Notes (1) ○: Allowed ×: Not

(2) Since the ON timer, sleep timer and OFF timer are set in parallel, when the times to turn ON and OFF the air-conditioner are duplicated, the setting of the OFF timer has priority.

(4) Hot start (Cold draft prevention at heating)

(a) Operating conditions

When either one of following conditions is satisfied, the hot start control is performed.

(i) From stop to heating operation

(ii) From cooling to heating operation

(iii) From heating thermostat OFF to ON

(iv) After completing the defrost operation (only on units with thermostat ON)

(b) Contents of operation

(i) Indoor fan motor control at hot start

1) Within 7 minutes after starting heating operation, the fan mode is determined depending on the condition of thermostat (fan control with heating thermostat OFF).

a) Thermostat OFF

i) Operates according to the fan control setting at heating thermostat OFF.

ii) Even if it changes from thermostat OFF to ON, the fan continues to operate with the fan control at thermostat OFF till the heat exchanger temperature sensor (Thi-R1 or R2, whichever higher) detects 35°C or higher.

iii) When the heat exchanger temperature sensor (Thi-R1 or R2, whichever higher) detects 35°C or higher, the fan operates with the set air flow volume.

- b) Thermostat ON
 - i) When the heat exchanger temperature sensor (Thi-R1 or R2, whichever higher) detects 25°C or lower, the fan is turned OFF and does not operate.
 - ii) When the heat exchanger temperature sensor (Thi-R1 or R2, whichever higher) detects 25°C or higher, the fan operates with the fan control at heating thermostat OFF.
 - iii) When the heat exchanger temperature sensor (Thi-R1 or R2, whichever higher) detects 35°C or higher, the fan operates with the set air flow volume.
- c) If the fan control at heating thermostat OFF is set at the “Set air flow volume” (from the remote control), the fan operates with the set air flow volume regardless of the thermostat ON/OFF.
- 2) Once the fan motor is changed from OFF to ON during the thermostat ON, the indoor fan motor is not turned OFF even if the heat exchanger temperature sensor detects lower than 25°C.

Note (1) When the defrost operation signal is received, it complies with the fan control during defrost operation.

- 3) Once the hot start is completed, it will not restart even if the temperature on the heat exchanger temperature sensor drops.
 - (ii) During the hot start, the louver is kept at the horizontal position.
 - (iii) When the fan motor is turned OFF for 7 minutes continuously after defrost operation, the fan motor is turned ON regardless of the temperatures detected with the indoor heat exchanger temperature sensor (Thi-R1, R2).

(c) Ending condition

- (i) If one of following conditions is satisfied during the hot start control, this control is terminated, and the fan is operated with the set air flow volume.
 - 1) Heat exchanger temperature sensor (Thi-R1 or R2, whichever higher) detects 35°C or higher.
 - 2) It has elapsed 7 minutes after starting the hot start control.

(5) Hot keep

Hot keep control is performed at the start of the defrost operation.

- (a) Control
 - (i) When the indoor heat exchanger temperature (detected with Thi-R1 or R2) drops to 35°C or lower, set the indoor fan to the low speed tap of each setting.
 - (ii) During the hot keep, the louver is kept at the horizontal position.
- (b) Ending condition

When the indoor fan is at the lower tap at each setting, it returns to the set air flow volume as the indoor heat exchanger temperature rises to 45°C or higher.

(6) Auto swing control

Note Even if [Auto Swing] is selected, the louver position with anti draft function is fixed to position 1.

(a) RC-EX3A

- (i) Louver control
 - 1) To operate the swing louver when the air-conditioner is operating, press the “Direction” button on the TOP screen of remote control. The wind direction select screen will be displayed.
 - 2) To swing the louver, touch the “Auto swing” button. The louver will move up and down. To fix the swing louver at a position, touch one of [1] - [4] buttons. The swing louver will stop at the selected position.
 - 3) Louver operation at the power on with a unit having the louver 4-position control function

The louver swings one time automatically (without operating the remote control) at the power on.

This allows the microcomputer recognizing and inputting the louver motor (LM) position.
- (ii) Automatic louver level setting during heating

At the hot start and the heating thermostat OFF, regardless whether the auto swing switch is operated or not (auto swing or louver stop), the louver takes the level position (in order to prevent blowing of cool wind). The louver position display LCD continues to show the display which has been shown before entering this control.
- (iii) Louver free stop control

If you touch the “Menu” → “Service setting” → “R/C function settings” buttons one after another on the TOP screen of remote control, the “Upper / lower flap control” screen is displayed. If the free stop is selected on this screen, the louver motor stops upon receipt of the stop signal from the remote control. If the auto swing signal is received from the remote control, the auto swing will start from the position before the stop.

(b) RC-E5

(i) Louver control

- 1) Press the “LOUVER” button to operate the swing louver when the air-conditioner is operating. “SWING \rightarrow ” is displayed for 3 seconds and then the swing louver moves up and down continuously.
- 2) To fix the swing louver at a position, press one time the “LOUVER” button while the swing louver is moving so that four stop positions are displayed one after another per second. When a desired stop position is displayed, press the “LOUVER” button again. The display stops, changes to show the “STOP 1 \rightarrow ” for 5 seconds and then the swing louver stops.
- 3) Louver operation at the power on with a unit having the louver 4-position control function
The louver swings one time automatically (without operating the remote control) at the power on. This allows inputting the louver motor (LM) position, which is necessary for the microcomputer to recognize the louver position.

Note (1) If you press the “LOUVER” button, the swing motion is displayed on the louver position LCD for 10 second. The display changes to the “SWING \rightarrow ” display 3 seconds later.

(ii) Automatic louver level setting during heating

At the hot start with the heating thermostat OFF, regardless whether the auto swing switch is operated or not (auto swing or louver stop), the louver takes the level position (In order to prevent the cold start). The louver position display LCD continues to show the display which has been shown before entering this control.

(iii) Louver-free stop control

When the louver-free stop has been selected with the indoor function of wired remote control “ \rightarrow POSITION”, the louver motor stops when it receives the stop signal from the remote control. If the auto swing signal is received from the remote control, the auto swing will start from the position where it was before the stop.

Note (1) When the indoor function of wired remote control “ \rightarrow POSITION” has been switched, switch also the remote control function “ \rightarrow POSITION” in the same way.

(7) Thermostat operation

(a) Cooling

- (i) Thermostat is operated with the room temperature control.
- (ii) Thermostat is turned ON or OFF relative to the set room temperature as shown below.

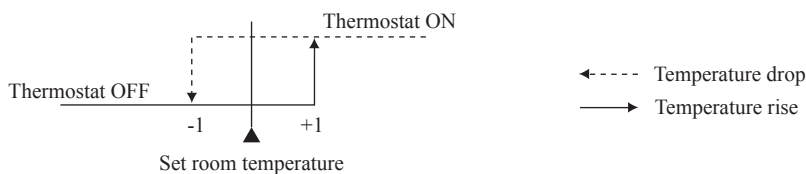

- (iii) Thermostat is turned ON when the room temperature is in the range of $-1 < \text{Set temperature} < +1$ at the start of cooling operation (including from heating to cooling).

(b) Heating

- (i) Thermostat is operated with the room temperature control.
- (ii) Thermostat is turned ON or OFF relative to the set room temperature as shown below.

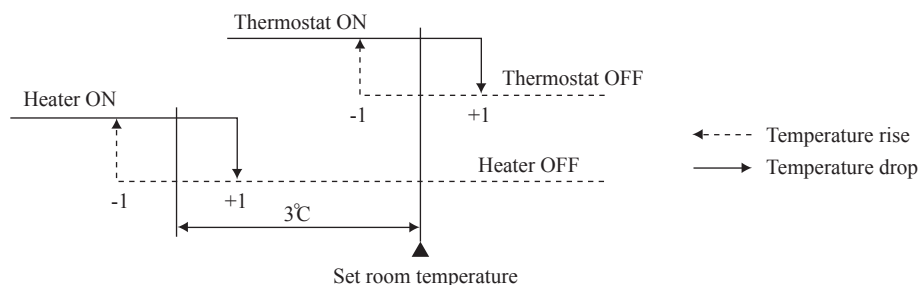

- (iii) Thermostat is turned ON when the room temperature is in the range of $-1 < \text{Set point} < +1$ at the start of heating operation (including from cooling to heating).

(c) Fan control during heating thermostat OFF

- (i) Following fan controls during the heating thermostat OFF can be selected with the indoor function setting of the wired remote control.
 - ① Low fan speed (Factory default), ② Set fan speed, ③ Intermittence, ④ Fan OFF
- (ii) When the “Low fan speed (Factory default)” is selected, the following taps are used for the indoor fans.
 - For DC motor : ULo tap
- (iii) When the “Set fan speed” is selected, it is operated with the set fan speed also in the thermostat OFF condition.
- (iv) If the “Intermittence” is selected, following controls are performed:
 - 1) If the thermostat is turned OFF during the heating operation, the indoor fan stops.
 - 2) Indoor fan OFF is fixed for 5 minutes. After the 5 minutes, the indoor fan is operated at ULo for 2 minutes. In the meantime the louver is controlled at level.
 - 3) After operating at ULo for 2 minutes, the indoor fan moves to the state of 1) above.
 - 4) If the thermostat is turned ON, it moves to the hot start control.
 - 5) When the heating thermostat is turned OFF, the remote control displays the temperature detected at the fan stop and revises the temperature later when the indoor fan changes from ULo to stop.
The remote control uses the operation data display function to display temperatures and updates values of temperature even when the indoor fan is turned OFF.
 - 6) When the defrost operation starts while the heating thermostat is turned OFF or the thermostat is turned OFF during defrost operation, the indoor fan is turned OFF. (Hot keep or hot start control takes priority.) However, the suction temperature is updated at every 7-minute.
 - 7) When the heating thermostat is turned ON or the operation is changed to another mode (including stop), this control is stopped immediately, and the operating condition is restored.
- (v) When the “Fan OFF” is selected, the fan on the indoor unit of which the thermostat has been turned OFF, is turned OFF. The same occurs also when the remote control sensor is effective.

(d) Fan control during cooling thermostat OFF (Except FDTC, FDTQ, FDUT15-56, FDUH, FDK, FDFW, FDFL, FDFU)

- (i) Following fan controls during the cooling thermostat OFF can be selected with the indoor function setting of the wired remote control.
 - ① Low fan speed, ② Set fan speed (Factory default), ③ Intermittence, ④ Fan OFF
- (ii) When the “Low fan speed” is selected, the following taps are used for the indoor fans.
 - For DC motor : ULo tap
- (iii) When the “Set fan speed” is selected, it is operated with the set fan speed also in the thermostat OFF condition.
- (iv) If the “Intermittence” is selected, following controls are performed:
 - 1) If the thermostat is turned OFF during the cooling operation, the indoor fan stops.
 - 2) Indoor fan OFF is fixed for 5 minutes. After the 5 minutes, the indoor fan is operated at ULo for 2 minutes.
 - 3) After operating at ULo for 2 minutes, the indoor fan moves to the state of 1) above.
 - 4) If the thermostat is turned ON, the fan starts operation at set fan speed.
 - 5) When the cooling thermostat is turned OFF, the remote control displays the temperature detected at the fan stop and revises the temperature later when the indoor fan changes from ULo to stop.
By using operation data display function at wireless remote control, the temperature as displayad and the value is updated including the fan stops.
 - 6) When the cooling thermostat is turned ON or the operation is changed to another mode (including stop), this control is stopped immediately, and the operating condition is restored.
- (v) When the “Fan OFF” is selected, the fan on the indoor unit of which the thermostat has been turned OFF, is turned OFF. The same occurs also when the remote control sensor is effective.

(8) Filter sign

As the operation time (Total ON time of ON/OFF switch) accumulates to 180 hours (1), “FILTER CLEANING” is displayed on the remote control. (This is displayed when the unit is in trouble and under the central control, regardless of ON/OFF)

Notes (1) Time setting for the filter sign can be made as shown below using the indoor function of wired remote control “Filter sign”. (It is set at Setting 1 at the shipping from factory.)

Filter sign setting	Function
Setting 1	Setting time: 180 h (Factory default)
Setting 2	Setting time: 600 h
Setting 3	Setting time: 1,000 h
Setting 4	Setting time: 1,000 h (Unit stop) ⁽²⁾

(2) After the setting time has elapsed, the “FILTER CLEANING” is displayed and, after operating for 24 hours further (counted also during the stop), the unit stops.

(9) Compressor inching prevention control

- (a) Once the indoor unit thermostat has been turned ON, the thermostat is not turned OFF for 2 minutes (*1) after the compressor ON even if the thermostat is turned OFF at the state of item (7).

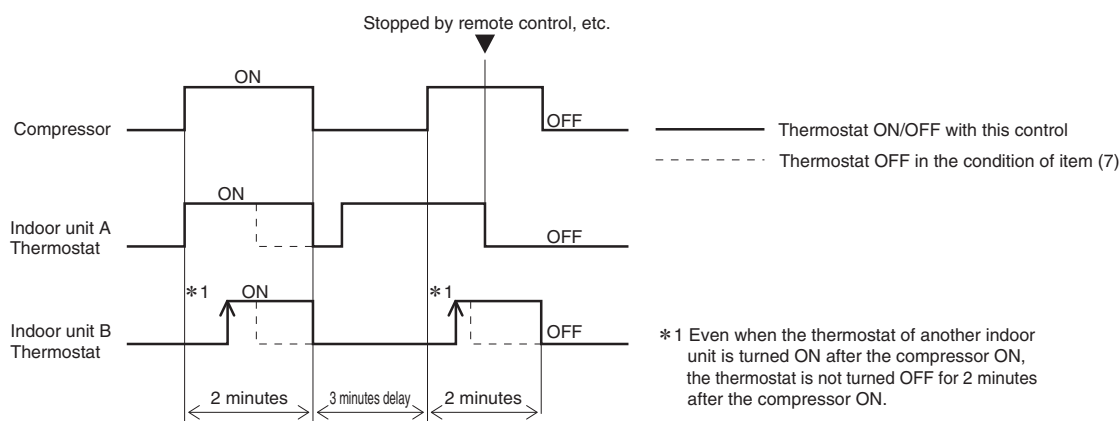

- (b) When the oil return control has started while the thermostat is turned ON, the thermostat is not turned OFF even if the thermostat OFF condition is satisfied during the oil return control.

(10) Drain pump control (Except FDK)

- (a) This control is operated when the inverter frequency is other than 0 Hz during the cooling operation and automatic cooling and dehumidifying operations.
- (b) Drain pump ON condition continues for 5 minutes even when it enters the OFF range according to (i) above after turning the drain pump ON, and then stops. The 5 minutes delay continues also in the event of anomalous stop.
- (c) The drain pump is operated with the 5 minutes delay operation when the compressor is changed from ON to OFF.
- (d) Even in conditions other than the above (such as heating, fan, stop, cooling thermostat OFF), the drain pump control is performed by the drain detection.
- (e) Following settings can be made using the indoor function setting of the wired remote control.
 - (i) 标准 [Standard (in cooling & dry)] : Drain pump is run during cooling and dry.
 - (ii) 标准 AND 制热 [Operate in standard & heating] : Drain pump is run during cooling, dry and heating.
 - (iii) 标准 AND 制热 AND 送风 [Operate in heating & fan] : Drain pump is run during cooling, dry, heating and fan.
 - (iv) 标准 AND 送风 [Operate in standard & fan] : Drain pump is run during cooling, dry and fan.

Note (1) Values in [] are for the RC-EX3A model.

(11) Drain pump abnormalities detection (Except FDK)

- (a) Drain detection switch is turned ON or OFF with the float switch (FS) and the timer.

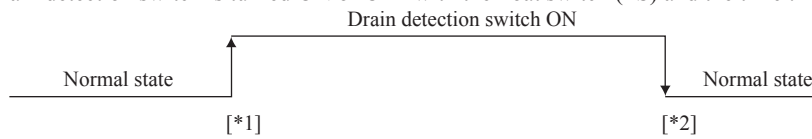

[*1] Drain detection switch is turned “ON” when the float switch “Open” is detected for 3 seconds continuously in the drain detectable space.

[*2] Drain detection switch is turned “OFF” when the float switch “Close” is detected for 10 seconds continuously.

- (i) It detects always from 30 seconds after turning the power ON.
 - 1) There is no detection of anomalous draining for 10 seconds after turning the drain pump OFF.
 - 2) Turning the drain detection switch “ON” causes to turn ON the drain pump forcibly.
 - 3) Turning the drain detection switch “OFF” releases the forced drain pump ON condition.
- (b) Indoor unit performs the control A or B depending on each operating condition.

	Indoor unit operation mode				
	Stop ⁽¹⁾	Cooling	Dry	Fan ⁽²⁾	Heating
Compressor ON	Control A				
Compressor OFF	Control B				

Notes (1) Including the stop from the cooling, dehumidifying, fan and heating, and the anomalous stop
 (2) Including the “Fan” operation according to the mismatch of operation modes

- (i) Control A
 - 1) If the float switch detects any anomalous draining condition, the unit stops with the anomalous stop (displays E9) and the drain pump starts. After detecting the anomalous condition, the drain motor continues to be ON.
 - 2) It keeps operating while the float switch is detecting the anomalous condition.
- (ii) Control B

If the float switch detects any anomalous drain condition, the drain motor is turned ON for 5 minutes, and at 10 seconds after the drain motor OFF it checks the float switch. If it is normal, the unit is stopped under the normal mode or, if there is any anomalous condition, E9 is displayed and the drain motor is turned ON. (The ON condition is maintained during the drain detection.)

(12) Operation check/drain pump test run operation mode

- (a) If the power is turned on by the dip switch (SW7-1) on the indoor unit control PCB when electric power source is supplied, it enters the mode of operation check/drain pump test run. It is ineffective (prohibited) to change the switch after turning power on.
- (b) When the communication with the remote control has been established within 60 seconds after turning power on by the dip switch (SW7-1) ON, it enters the operation check mode. Unless the remote control communication is established, it enters the drain pump test run mode.

Note (1) To select the drain pump test run mode, disconnect the remote control connector (CnB) on the indoor PCB to shut down the remote control communication.

- (c) Operation check mode

There is no communication with the outdoor unit but it allows performing operation in respective modes by operating the remote control.
- (d) Drain pump test run mode (Except FDK)

As the drain pump test run is established, the drain pump only operates and during the operation protective functions by the microcomputer of indoor unit become ineffective.

(13) Cooling, dehumidifying frost protection

- (a) To prevent frosting during cooling mode or dehumidifying mode operation, the of thermostat-OFF if the indoor heat exchanger temperature (detected with Thi-R) drops to 1.0 °C or lower at 4 minutes after the thermostat-ON. If the indoor unit heat exchanger temperature is 1.0 °C or lower after 5 minutes, the indoor unit is controlled thermostat-OFF. If it becomes 10°C or higher, the control terminates. When the indoor heat exchanger temperature has become as show, the indoor unit send heat source unit the “Anti-frost” signal.

- Frost prevention temperature setting can be selected with the indoor unit function setting of the wired remote control.

Item	Symbol	A
Temperature - Low (Factory default)		1.0
Temperature - High		2.5

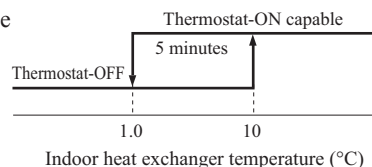

(b) Selection of indoor fan speed

If it enters the frost prevention control during cooling operation (excluding dehumidifying), the indoor fan speed is switched.

- (i) When the indoor return air detection temperature (detected with Thi-A) is 23°C or higher and the indoor heat exchanger temperature (detected with Thi-R) detects the compressor frequency drop start temperature A°C+1°C, of indoor fan speed is increased by 20min⁻¹.
- (ii) If the phenomenon of (i) above is detected again after the acceleration of indoor fan, indoor fan speed is increased further by 20min⁻¹.

Note (1) Indoor fan speed can be increased by up to 2 taps.

- Compressor frequency drop start temperature

Hs > 50%

Symbol	Item	Low	High
A		1.0	2.5
B		2.5	4.0

Hs ≤ 50%

Symbol	Item	Low	High
A		-0.5	1.0
B		1.0	2.5

Note (1) Frost prevention temperature setting can be selected with the indoor unit function setting of the wired remote control.

(14) Anomalous fan motor

- (a) After starting the fan motor, if the fan motor speed is 200min⁻¹ or less is detected for 30 seconds continuously and 4 times within 60 minutes, then fan motor stops with the anomalous stop (E16).
- (b) If the fan motor fails to reach at -50 min⁻¹ less than the required speed, it stops with the anomalous stop (E20).

(15) Plural unit control – Control of 16 units group by one remote control

(a) Function

One remote control can control a group of multiple number of unit (Max. 16 indoor units). “Operation mode” which is set by the remote control can operate or stop all units in the group one after another in the order of unit. No.⁽¹⁾. Thermostat and protective function of each unit function independently.

Note (1) Unit No. is set by SW1, SW2, and SW5-2 on the indoor control PCB.

(b) Display to the remote control

- (i) Central or each remote control basis, heating preparation: the smallest unit No. among the operating units in the remote mode (or the center mode unless the remote mode is available) is displayed.
- (ii) Inspection display, filter sign: Any of unit that starts initially is displayed.

(c) Confirmation of connected units

(i) In case of RC-EX3A remote control

If you touch the buttons in the order of “Menu” → “Service setting” → “Service & Maintenance” → “Service password” → “IU address” on the TOP screen of remote control, the indoor units which are connected are displayed.

(ii) In case of RC-E5 remote control

Pressing “AIR CON No.” button on the remote control displays the indoor unit address. If “▲” “▼” button is pressed at the next, it is displayed orderly starting from the unit of smallest No.

(d) In case of anomaly

If any anomaly occurs on a unit in a group (a protective function operates), that unit stops with the anomalous stop but any other normal units continue to run as they are.

(e) Signal wiring procedure

Signal wiring between indoor and outdoor units should be made on each unit same as the normal wiring. For the group control, connect the remote control wiring to each indoor unit via terminal block for the remote control.

Connect the remote control wiring separately from the power source cable or wires of other electric devices (AC220V or higher).

(16) High ceiling control

When sufficient air flow rate cannot be obtained from the indoor unit which is installed at a room with high ceiling, the air flow rate can be increased by changing the fan tap. To change the fan tap, use the indoor unit function “FAN SPEED SET” on the wired remote control.

Fan tap	Indoor unit air flow setting				
	STANDARD	Hi2 - Hi - Me - ULo	Hi - Me - ULo	Hi - ULo	Hi - Me
FAN SPEED SET	STANDARD	P-Hi2 - Hi - Me - ULo	P-Hi1 - Hi - Me	P-Hi1 - Me	P-Hi1 - Hi
	HIGH SPEED1	P-Hi2 - Hi - Me - Lo	Hi - Me - Lo	Hi - Lo	Hi - Me
	HIGH SPEED2	P-Hi2 - Hi - Me - Lo	Hi - Me - Lo	Hi - Lo	Hi - Me

Notes (1) Factory default is STANDARD.

(2) At the hot-start and heating thermostat OFF, or other, the indoor fan is operated at the low speed tap of each setting.

(3) This function is not able to be set with wireless remote control or simple remote control (RCH-E3).

(17) Abnormal temperature sensor (return air/indoor heat exchanger) broken wire/short-circuit detection

- (a) Broken wire detection
If the return air temperature sensor detects broken wire for 5 seconds continuously, the compressor stops (E7). If the heat exchanger temperature sensor detects broken wire for 5 seconds continuously at 2 minutes and 20 seconds after the compressor ON, the compressor stops (E6).
- (b) Short-circuit detection
If the heat exchanger temperature sensor detects short-circuit for 5 seconds continuously at 2 minutes and 20 seconds after the compressor ON during cooling operation, the compressor stops (E6).

(18) External input/output control (CnT or CnTA)

External input/output connectors are provided on the indoor unit control PCB, and each input/output is possible to be changed by RC-EX3A. Be sure to connect the wired remote control to the indoor unit. Remote operation with CnT/CnTA only is not possible.

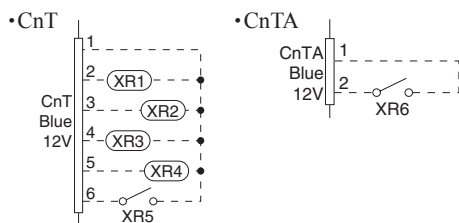

Input/Output	Connector	Factory default setting	RC-EX3A function name
Output	CnT-2 (XR1)	Operation output	External output 1
	CnT-3 (XR2)	Heating output	External output 2
	CnT-4 (XR3)	Thermostat ON output	External output 3
	CnT-5 (XR4)	Inspection (Error) output	External output 4
Input (Volt-free contact)	CnT-6 (XR5)	Remote operation input	External input 1
	CnTA (XR6)	Remote operation input	External input 2

■ Priority order for combinations of CnT and CnTA input.

		CnTA						
		① Operation stop level	② Operation stop pulse	③ Operation permission/prohibition	④ Operation permission/prohibition pulse	⑤ Cooling/heating selection level	⑥ Cooling/heating selection pulse	⑦ Emergency stop
CnT	① Operation stop level	CnT ①	CnT ①	CnT ① +CnTA ②	CnT ①	CnT ① /CnTA ⑤	CnT ① /CnTA ⑥	CnT ① <CnTA ⑦
	② Operation stop pulse	CnT ②	CnT ②	CnT ② +CnTA ③	CnT ②	CnT ② /CnTA ⑤	CnT ② /CnTA ⑥	CnT ② <CnTA ⑦
	③ Operation permission/prohibition level	CnT ③ >CnTA ①	CnT ③ >CnTA ②	CnT ③ +CnTA ③	CnT ③	CnT ③ /CnTA ⑤	CnT ③ /CnTA ⑥	CnT ③ <CnTA ⑦
	④ Operation permission/prohibition pulse	CnT ④	CnT ④	CnT ④ +CnTA ③※	CnT ④	CnT ④ /CnTA ⑤	CnT ④ /CnTA ⑥	CnT ④ <CnTA ⑦
	⑤ Cooling/heating selection level	CnT ⑤ /CnTA ①	CnT ⑤ /CnTA ②	CnT ⑤ /CnTA ③	CnT ⑤ /CnTA ④	CnT ⑤	CnT ⑤	CnT ⑤ /CnTA ⑦
	⑥ Cooling/heating selection pulse	CnT ⑥ /CnTA ①	CnT ⑥ /CnTA ②	CnT ⑥ /CnTA ③	CnT ⑥ /CnTA ④	CnT ⑥	CnT ⑥	CnT ⑥ /CnTA ⑦
	⑦ Emergency stop	CnT ⑦ >CnTA ①	CnT ⑦ >CnTA ②	CnT ⑦ >CnTA ③	CnT ⑦ >CnTA ④	CnT ⑦ /CnTA ⑤	CnT ⑦ /CnTA ⑥	CnT ⑦ +CnTA ⑦

Note (1) Following operation commands are accepted when the operation prohibition is set with CnTA as indicated with *.

Individual operation command from remote control, test run command from outdoor unit and operation command from option device, CnT input.

Reference: Explanation on the codes and the combinations of codes in the table above

1. In case of CnT “Number”, the CnT “Number” is adopted and CnTA is invalidated.
 2. In case of CnTA “Number”, the CnTA “Number” is adopted and CnT is invalidated.
 3. In case of CnT “Number”/CnTA “Number”, the CnT “Number” and the CnTA “Number” become independent functions each other.
 4. In case of CnT “Number” + CnTA “Number”, the CnT “Number” and the CnTA “Number” become competing functions each other.
 5. In case of CnT “Number” > CnTA “Number”, the function of CnT “Number” supersedes that of CnTA “Number”.
 6. In case of CnT “Number” < CnTA “Number”, the function of CnTA “Number” supersedes that of CnT “Number”.
- (The “Number” above means ① - ⑥ in the table.)

(a) Output for external control (remote display)

Indoor unit outputs the following signal for operation status monitoring.

Output name	Condition
1 Operation output	During operation
2 Heating output	During heating operation
3 Thermostat ON output	During compressor operation
4 Inspection (Error) output	When anomalous condition occurs.
5 Cooling output	During cooling operation
6 Fan operation output 1	When indoor unit's fan is operating
7 Fan operation output 2	When indoor unit's fan is operating, and fan speed is higher than Hi speed.
8 Fan operation output 3	When indoor unit's fan is operating, and fan speed is Lower than Me speed.
9 Defrost/oil return output	When indoor unit receive defrost/oil return signal from the outdoor unit.
10 Ventilation output	When "Venti.ON" is selected from remote control
11 Free cooling output	When the ambient temp. is between 10-18 °C in cooling and fan operation
12 Indoor unit overload alarm output	Refer to "IU overload alarm"

(b) Input for external control

The external input for the indoor unit can be selected from the following input by the wired remote control.

The input connectors (CnT-6 and CnTA) are equipped on the indoor unit control PCB.

“LEVEL INPUT(Factory default)” or ”PULSE INPUT” is selectable from the wired remote control.

	Input name	Content
1	Run/Stop (Factory default)	Refer to [(19) (c) Remote operation input]
2	Permission/Prohibition	Refer to [(20) Operation permission/prohibition]
3	Cooling/Heating	Refer to [(22) Selection of cooling/heating external input function]
4	Emergency stop	Refer to [(23) Emergency stop input]
5	Setting temperature shift	Set temperature is shifted by +2/-2°C in cooling/heating.
6	Forced thermo-OFF	Unit goes thermo off.
7	Temporary stop	Refer to [(21) Temporary stop input]
8	Silent mode	Outdoor unit silent mode is activated.

(c) Remote operation input

The indoor unit operation can be controlled by external input.

However it is not effective when “Center mode” is selected by central control.

Only the “LEVEL INPUT” is recommended for this input, and operation status is changed as follows.

(i) In case of “Level input” setting (Factory default)

Input signal to CnT-6 or CnTA is OFF→ON unit ON

Input signal to CnT-6 or CnTA is ON→OFF unit OFF

Operation is not inverted.

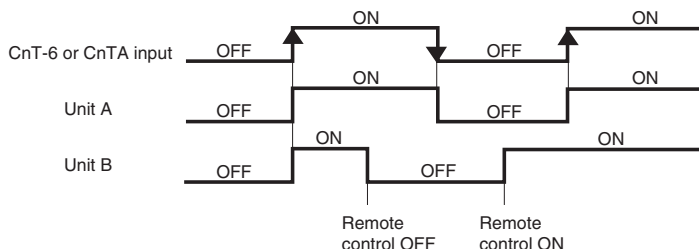

Note: The latest operation has priority.

It is available to operate/stop by remote control or central control.

(ii) In case of “Pulse input” setting (Local setting)

It is effective only when the input signal to CnT-6 or CnTA is changed OFF→ON, and at that time unit operation [ON/OFF] is inverted.

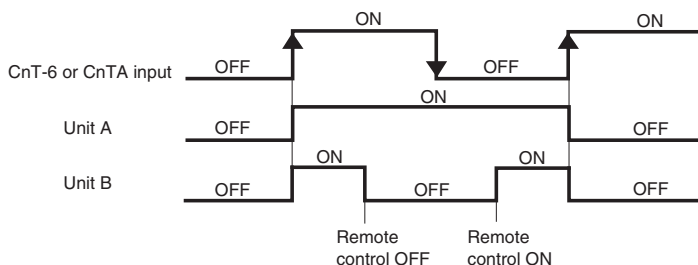

(iii) In case of multiple units (Max. 16 indoor units group) are connected to one wired remote control

When the R/C function setting of wired remote control for “External control set” is changed from “Individual (Factory default)” to “ For all units”, all units connected in one wired remote control system can be controlled by external operation input.

(19) Operation permission/prohibition

(In case of adopting card key switches or commercially available timers)

When the external input is selected to “Permission/Prohibition”, this control becomes effective.

However it is not effective when “Center mode” is selected by central control.

Connector	Indoor function	
	RC-EX3A	RC-E5
CnT	External input 1 : Permission/Prohibition	Operation permission/Prohibition : Valid
CnTA	External input 2 : Permission/Prohibition	No function

Only the “LEVEL INPUT” is recommended for this input, and operation status is changed as follows.

- (a) In case of “Level input” setting (Factory default)
 - (i) When card key switch is ON (CnT-6 or CnTA ON: Operation permission), start/stop operation of the unit from the wired remote control becomes available.
 - (ii) When card key switch is OFF (CnT-6 or CnTA OFF: Operation prohibition), the unit stops operation in conjunction with OFF signal, and start/stop operation of the unit from the wired remote control becomes not available.
- (b) In case of “Pulse input” setting (Local setting)
 - (i) When card key switch is ON (Operation permission), the unit starts operation in conjunction with ON signal, and also start/stop operation of the unit from the wired remote control becomes available.
 - (ii) When card key switch is OFF (Operation prohibition), the unit stops operation in conjunction with OFF signal, and start/stop operation of the unit from the wired remote control becomes not available.

(c) In case of CnT ① operation stop level > CnTA ③ operation permission/prohibition level

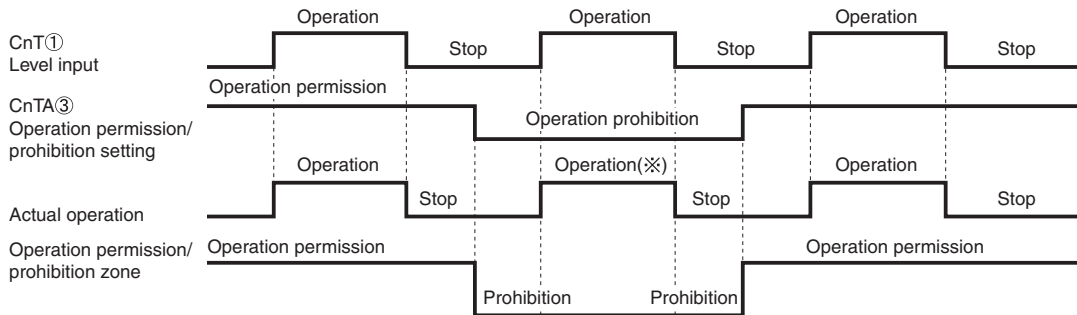

(※) CnT level input supersedes CnTA operation prohibition.

(d) In case of CnT ③ operation permission/prohibition level + CnTA ③ operation permission/prohibition level

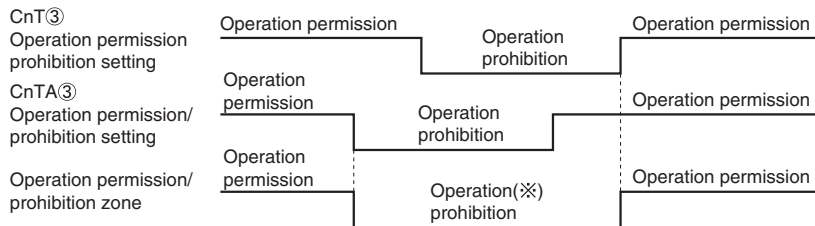

(※) Operation prohibition zone is determined by the OR judgment between CnT operation prohibition zone and CnTA operation prohibition zone.

(e) In case of CnT ③ operation permission/prohibition level > CnTA ② operation/stop pulse

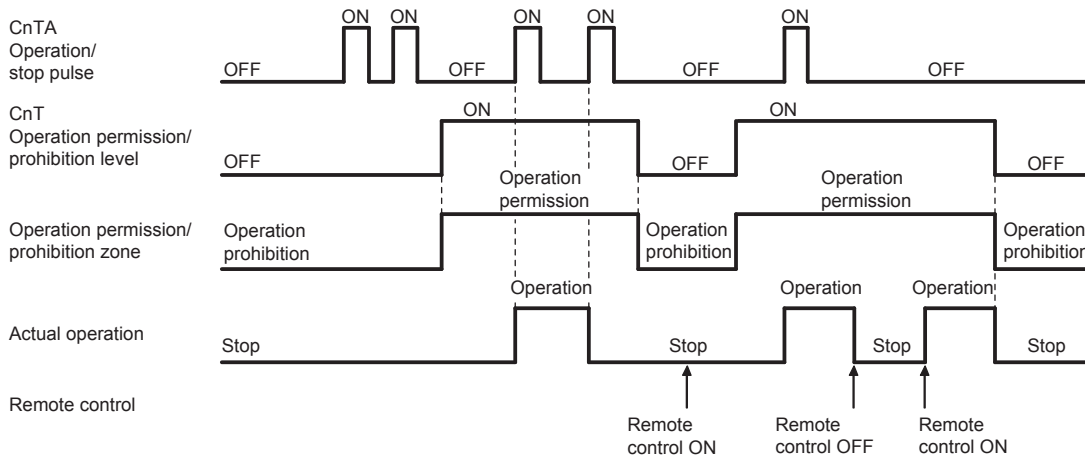

Note (1) If it is prohibited by CnT, all “Operation” and “Stop” commands are not accepted.

(f) In case of CnT② operation/stop pulse + CnTA ③ operation permission/prohibition level

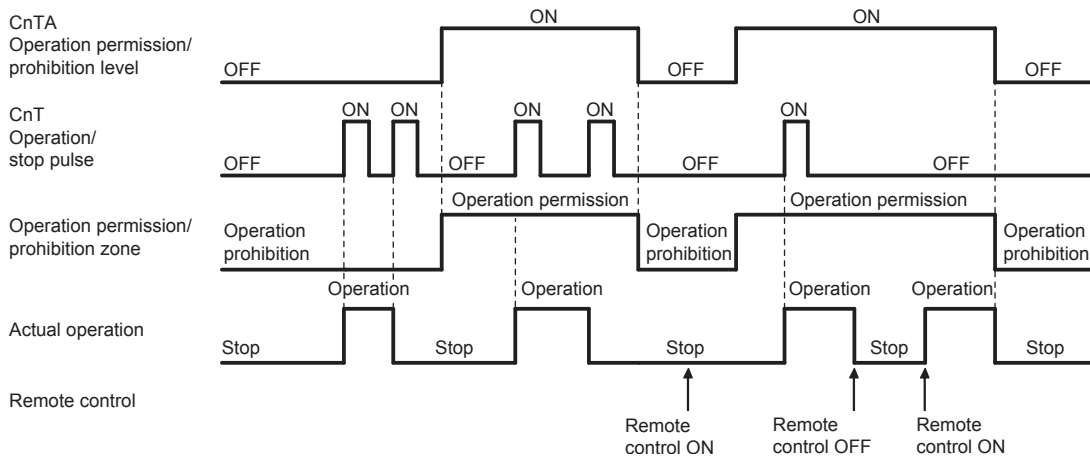

(20) Temporary stop input

In case of temporary stop, operation lamp of remote control lights, but indoor unit stop the operation.

(a) In case of “Level input” setting (Factory default)

Input signal to CnT-6 or CnTA is OFF → ON : Temporary stop
 Input signal to CnT-6 or CnTA is OFF → ON : Normal operation

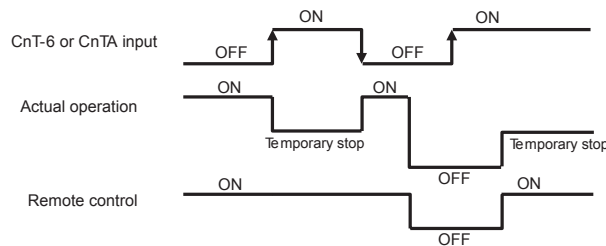

(b) In case of “Pulse input” setting (Local setting)

It is effective only when the input signal is changed OFF→ON, and “temporary stop/normal operation” is inverted.

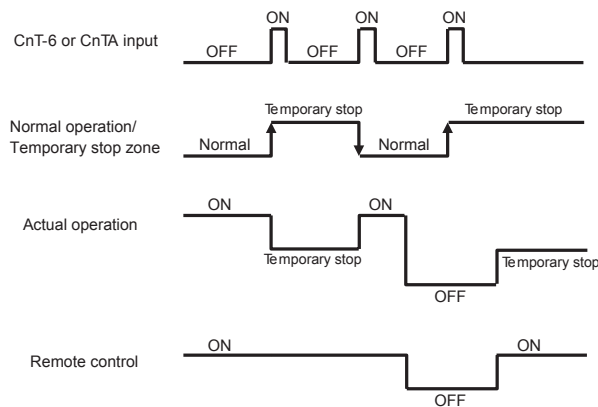

(21) Selection of cooling/heating external input function

When “External input 1 or 2 setting: Cooling/heating” is set by the indoor unit function from remote control, the cooling or heating is selected with CnT-6 or CnTA.

(a) In case of “Level input” setting (Factory default)

- CnT-6 or CnTA: OPEN → Cooling operation mode
- CnT-6 or CnTA: CLOSE → Heating operation mode

(b) In case of “Pulse input” setting (Local setting)

If the external input is changed OPEN → CLOSE, operation modes are inverted (Cooling → Heating or Heating → Cooling).

- (c) If the cooling/heating selection signal is given by the external input, the operation mode is transmitted to the remote control.

■ Selection of cooling/heating external input function

External input selection	External input method	Operation	
Cooling/heating selection	Level	External input (CnT or CnTA)	
		Cooling/heating	
		Cooling/heating (Competitive)	
	Pulse	External input (CnT or CnTA)	
		Cooling/heating	
		Cooling/heating (Competitive)	

(22) Emergency stop input

When the external input is selected to “Emergency stop”, it is possible to stop the outdoor unit operation by the external input to the indoor unit.

(a) Function setting

Emergency stop input can be selected by the indoor function of wired remote control.

Connector	Indoor function	
	RC-EX3A	RC-E5
CnT	External input 1 : Emergency stop	Emergency stop : Valid
CnTA	External input 2 : Emergency stop	No function

(b) Emergency stop control

When the external input is OFF, the indoor and outdoor units stop.

The indoor unit receive the external input stops the operation, and the outdoor unit which the stopped indoor unit are connected stops with [E-63].

(23) Room temperature detection temperature compensation during heating

With the standard specification, the compressor is turned ON/OFF with the thermostat setting temperature. When the thermostat is likely to turn OFF earlier because the unit is installed at the ceiling where warm air tends to accumulate, the setting can be changed with the wired remote control indoor unit function “~~SP~~ OFFSET”. The compressor and the heater are turned ON/OFF at one of the setting temperature +3, +2 or +1°C in order to improve the feeling of heating. The setting temperature, however, has the upper limit of 30°C.

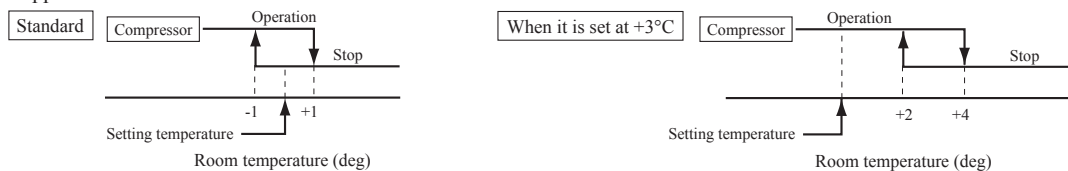

(24) Return air temperature compensation

This is the function to compensate the deviation between the detection temperature by the return air temperature sensor and the measured temperature after installing the unit.

(a) It is adjustable in the unit of 0.5°C with the wired remote control indoor unit function “RETURN AIR TEMP”.

- +1.0°C, +1.5°C, +2.0°C
- -1.0°C, -1.5°C, -2.0°C

(b) Compensated temperature is transmitted to the remote control and the outdoor unit.

Note (1) The detection temperature compensation is effective on the indoor unit thermistor only.

(25) High power operation (RC-EX3A only)

It operates at with the setting temperature fixed at 16°C for cooling, 30°C for heating and maximum indoor fan speed for 15 minutes maximum.

(26) Energy-saving operation (RC-EX3A only)

It operates with the setting temperature fixed at 28°C for cooling, 22°C for heating or 25°C for auto. When fan control in cooling/heating thermo-OFF setting is “Set fan speed”, fan speed during thermo-OFF is changed to “Low”. (Maximum capacity is restricted at 80%.)

(27) Warm-up control (RC-EX3A only)

Operation will be started 5 to 60 minutes before use according to the forecast made by the microcomputer which calculates when the operation should be started in order to warm up the indoor temperature near the setting temperature at the setting time of operation start.

(28) Home leave mode (RC-EX3A only)

When the unit is not used for a long period of time, the room temperature is maintained at a moderate level, avoiding extremely hot or cool temperature.

- (a) Cooling or heating is operated according to the outdoor temperature (factory setting 35°C for cooling, 0°C for heating) and the setting temperature. (factory setting 33°C for cooling, 10°C for heating)
- (b) Setting temperature and indoor fan speed can be set by RC-EX3A.

(29) Auto temperature setting (RC-EX3A only)

Setting temperature is adjusted automatically at the adequate temperature the center setting temperature is 24°C by correcting the outdoor air temperature.

(30) Fan circulator operation (RC-EX3A only)

When the fan is used for circulation, the unit is operated as follows depending on the setting with the remote control.

- (a) If the invalid is selected with the remote control, the fan is operated continuously during the fan operation. (normal fan mode)
- (b) If the valid is selected with the remote control, the fan is operated or stopped when on the difference of the remote control temperature sensor and the return air temperature sensor becomes bigger than 3°C.

(31) The operation judgment is executed every 5 minutes (RC-EX3A only)

Setting temperature T_s is changed according to outdoor temperature.

This control is valid with cooling and heating mode. (Not auto mode)

- (a) Operate 5 minutes forcedly.
- (b) Setting temperature is adjusted every 10 minutes.
 - (i) Cooling mode
 $T_s = \text{outdoor temperature} - \text{offset value}$
 - (ii) Heating mode
 $T_s = \text{outdoor temperature} + \text{offset value}$
- (c) If the return air temperature lower than 18°C in cooling or return air temperature becomes higher than 25°C in heating, unit goes thermostat OFF.

(32) Auto fan speed control (RC-EX3A only)

In order to reach the room temperature to the set temperature as quickly as possible, the air flow rate is increased when the set temperature of thermostat differs largely from the return air temperature. According to temperature difference between set temperature and return air temperature, indoor fan tap are controlled automatically.

- Auto 1: Changes the indoor fan tap within the range of Hi ↔ Me ↔ Lo.
- Auto 2: Changes the indoor fan tap within the range of P-Hi ↔ Hi ↔ Me ↔ Lo.

(33) Indoor unit overload alarm (RC-EX3A only)

If the following condition is satisfied at 30 minutes after starting operation, RC-EX3A shows maintenance code "M07" and the signal is transmitted to the external output (CnT-2-5).

It is necessary to select "Indoor unit overload alarm output" by the external output setting.

- Cooling, Dry, Auto(Cooling) : Indoor air temperature = Set room temperature by remote control + Alarm temperature difference
- Heating, Auto(Heating) : Indoor air temperature = Set room temperature by remote control - Alarm temperature difference

Alarm temperature difference is selectable between 5 to 10°C.

If the following condition is satisfied or unit is stopped, the signal is disappeared.

- Cooling, Dry, Auto(Cooling) : Indoor air temperature = Set room temperature + Alarm temperature difference -2°C
- Heating, Auto(Heating) : Indoor air temperature = Set room temperature - Alarm temperature difference +2°C

(34) Peak-cut timer (RC-EX3A only)

Power consumption can be reduced by restricting the maximum capacity.

Set the [Start time], the [End time] and the capacity limit % (Peak-cut %).

- 4-operation patterns per day can be set at maximum.
- The setting time can be changed by 5-minutes interval.
- The selectable range of capacity limit % (Peak-cut %) is from 0% to 40-80% (20% interval).
- Holiday setting is available.

(35) Motion sensor control (RC-EX3A only)

The sensor determines the presence of people and the amount of activity, and the following controls are done by the motion sensor.

Following settings are necessary to activate motion sensor control.

- (a) Infrared (motion) sensor setting: Installation setting of remote control
The indoor unit which is set to "Enable" become valid.
- (b) Infrared (motion) sensor control: Energy-saving setting of remote control
The function which is set to "Enable" become valid.
 - (i) Power saving control
The set temperature is adjusted according to the presence of people and their amount of activity detected by the infrared sensor.
 - (ii) Auto-off control
When no activity is detected for 1 hour, unit will go stand-by mode. Unit will re-start operation automatically by activity detection during the stand-by mode.

1.4 Operation control function by the outdoor control

(A) Normal control

(1) Operation of major functional components under each operation mode

Functional item \ Operation mode	Cooling/Dehumidifying		Fan	Heating		
	Thermostat ON	Thermostat OFF		Thermostat ON	Thermostat OFF	Defrost
Compressor (CM)	○	×	×	○	×	○
Magnetic contactor CM1 (52X1, 52X2)	○	○	×/○	○	○	○
Outdoor fan motor (FMO-1)	○	×/○	×/○	○/×	×/○	○→×
Outdoor fan motor (FMO-2)	○/×	×/○	×/○	○/×	×/○	○→×
4-way valve (20S)	×	×	×	○	○	○→×
Heating electronic expansion valve (EEVH)	Fully open	Fully open	※1	Opening Angle Control	※2	Fully closed / Fully open
Super cooling coil electronic expansion valve (EEVSC)	Opening Angle Control	Fully closed	Fully closed	Fully closed	Fully closed	Fully closed
Solenoid valve (SV1) (oil return)	○/×	×	×	○/×	×	○/×
Solenoid valve (SV6) (fluid return)	○/×	○/×	×	○/×	○/×	○/×
Solenoid valve (SV11) (gas bypass)	×	×	×	○/×	×	×
Crankcase heater (CH)	○/×	○/×	○	○/×	○/×	○/×

Notes (1) It means ○ : ON, × : OFF, ○/× : -, ×/○ : ON or OFF.

(2) This shows the state of output when all indoor units are under the same mode.

(3) ※1 : When stopped from cooling, it is fully open

When stopped from heating, it is fully closed unless another degree of opening is specified by the electronic expansion valve (EEV) control at the stop.

※2 : When stopped from heating, it is fully closed unless another degree of opening is specified by the electronic expansion valve (EEV) control at the stop.

(2) Compressor pre-start control

(a) Remote control full stop → Operation

(i) Starting conditions

- When it has changed to the compressor operation frequency command > 0 Hz from the state of compressor stopping.

(ii) Control contents

- It sets the compressor operation frequency command = 0 Hz, and then after this control ends, It starts the compressor.

(iii) Ending conditions

When all of following conditions are satisfied

- ① It has elapsed 15 seconds after the start of this control.

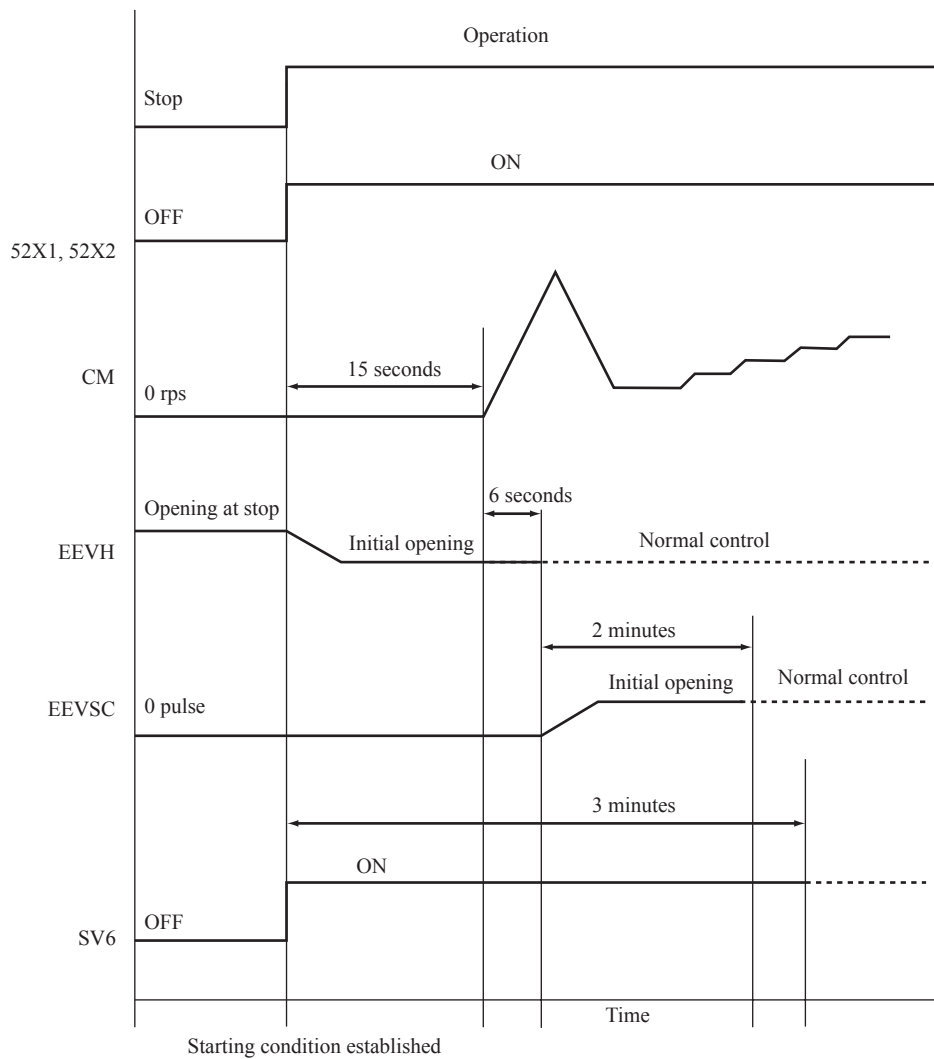

• Meaning of marks

52X1, 52X2	Solenoid for compressor	CM	Compressor
EEVH	Heating electronic expansion valve	EEVSC	Subcooling coil electronic expansion valve
SV6	Solenoid valve [Oil return]	—	—

(b) Cooling → Heating

- (i) Starting conditions
 - When the outdoor unit operation mode is changed from the cooling operation to heating operation
- (ii) Control contents
 - 1) When the compressor is operating, it makes the compressor stopped.
 - 2) Each functional component operates according to the sequence shown below.
- (iii) Ending conditions
 - End of sequence

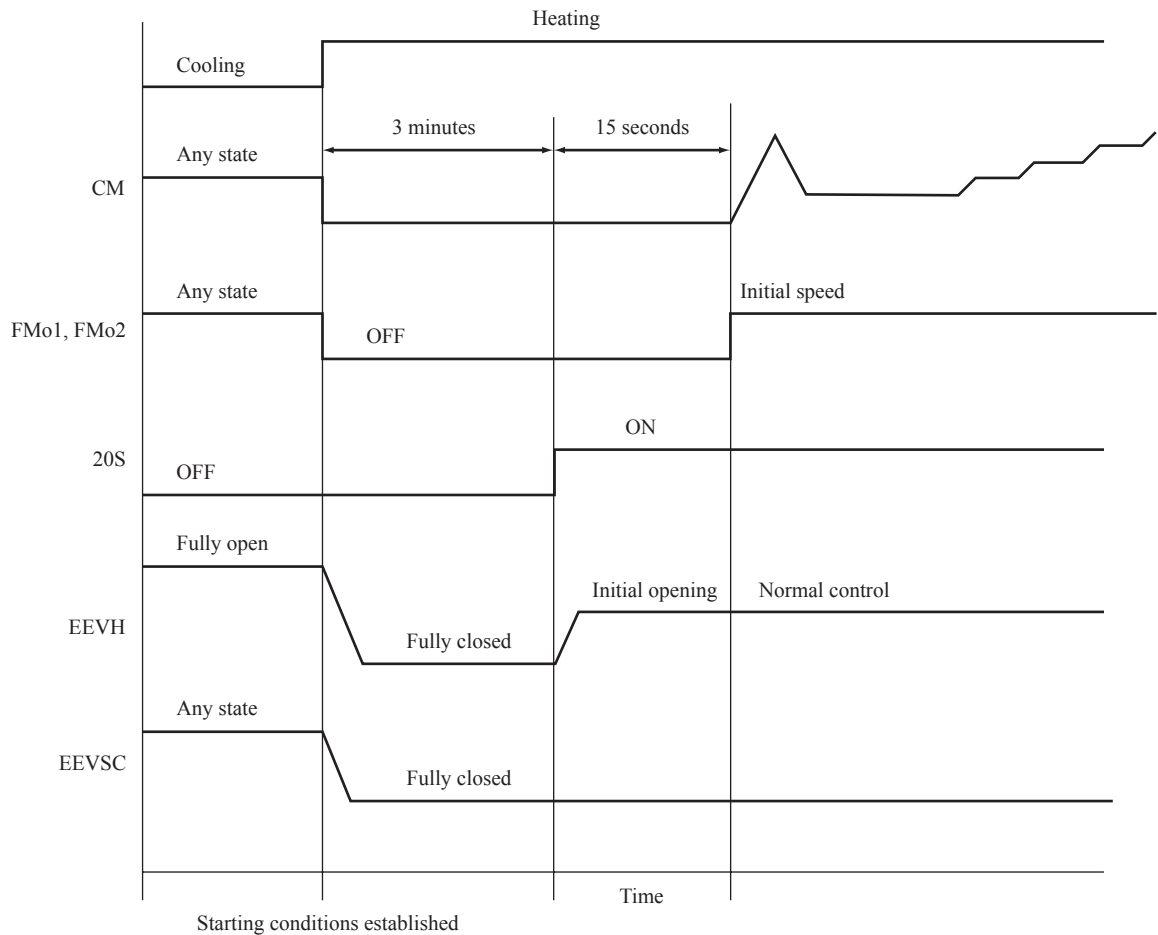

• Meaning of marks

CM	Compressor	EEVH	Heating electronic expansion valve
FMo1, FMo2	Outdoor fan motor	EEVSC	Subcooling coil electronic expansion valve
20S	4-way valve	—	—

(c) Heating → Cooling

- (i) Starting conditions
 - When the outdoor unit operation mode is changed from the heating operation to cooling operation
- (ii) Control contents
 - 1) When the compressor is operating, it makes the compressor stopped.
 - 2) Each functional component operates according to the sequence shown below.
- (iii) Ending conditions
 - End of sequence

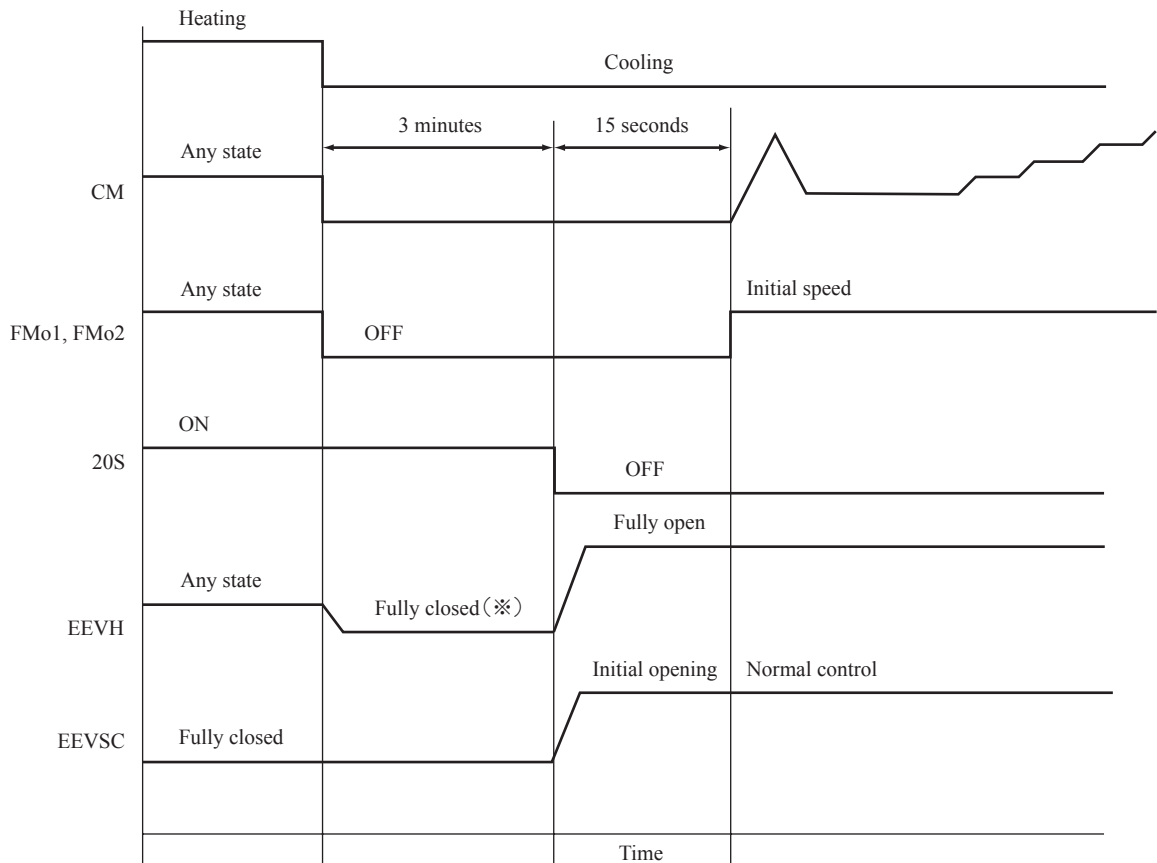

Starting conditions established

Note (1) ※ : It is fully closed till the end of 3-minute delay after the automatic reset.

• Meaning of marks

CM	Compressor	EEVH	Heating electronic expansion valve
FMO1, FMO2	Outdoor fan motor	EEVSC	Subcooling coil electronic expansion valve
20S	4-way valve	—	—

(3) Compressor control

(a) 4-way valve switching safeguard

In order to switch 4-way valve completely, it makes the compressor speed increasing as follows.

- (i) This control starts to increase the compressor speed from 10 rps after the compressor pre-start control ends.
- (ii) The target compressor speed is shown in following table.

Model	Item	4-way valve switching safeguard/Target compressor speed	
		Frequency (Fk)	Speed (rps)
FDC224KXZME1		70	50
FDC280KXZME1			
FDC335KXZME1		71	42

(b) Compressor protection start

After the 4-way valve switching safeguard, the compressor is controlled with the following compressor protection start.

- ① Compressor protection start, normal
- ② Compressor protection start A
- ③ Compressor protection start B

		Initial start remote control ON error reset	Thermostat ON start	
			Operation mode is changed during thermostat OFF	Operation mode is not changed during thermostat OFF
Compressor ON Initial	Less than 45 min after power ON	Compressor protection start B	Compressor protection start B	Compressor protection start B
	45min. or more after power ON	Compressor protection start A	Compressor protection start A	Compressor protection start A
Compressor ON Second & later	Less than 45 min after stop	Compressor normal protection start	Compressor normal protection start	Compressor normal protection start
	45min. or more after stop	Compressor protection start A	Compressor protection start A	Compressor protection start A

- (i) Compressor protection start, normal

< Control contents >

Compressor maintains operation at lower limit frequency, after 4-way valve switching safeguard ends.

(During this control, compressor speed is prohibited to increase.)

After this control ends, compressor speed is governed by the compressor speed control.

< Ending conditions >

When either one of the following conditions is established

- a) When it has elapsed 1 minute and 45 seconds after the start

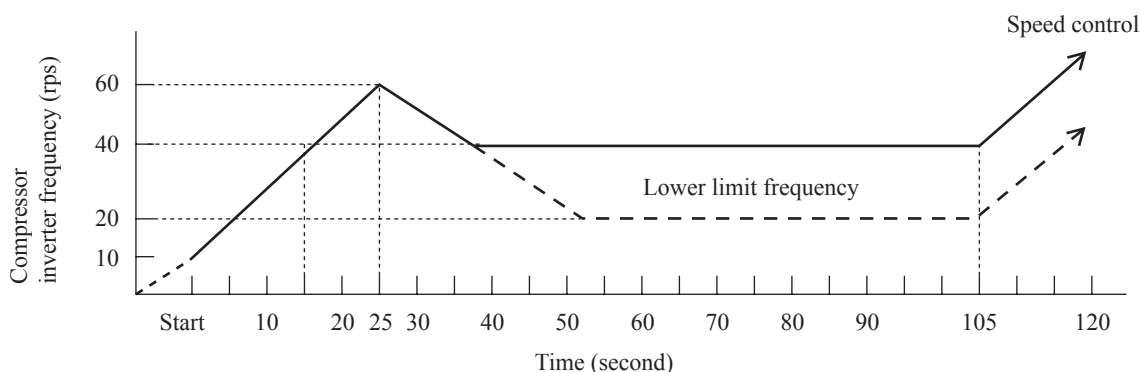

- (ii) Compressor protection start A

< Control contents >

- ① Compressor maintains operation at lower limit frequency, after 4-way valve switching safeguard ends.

If the time from starting till reaching the lower limit frequency after 4-way valve switching safeguard operation has elapsed 1minute, the target frequency is changed to that of 1minute later from the lower limit frequency.

- ② During this control, the target frequency is increased at a rate of 5 rps/minute from the lower limit frequency.

Note (1) The starting point of this control is the completion point of inverter start (10 rps).

< Ending conditions >

When either one of following conditions is established

- a) When the frequency upper limit increase by this control continued for 15 minutes in total
 When the inverter has stopped within 15 minutes after the start and is started again, it starts with the normal protection start and increases the frequency upper limit at a rate of 5 rps/minute till the frequency increase continues for 15 minutes in total.

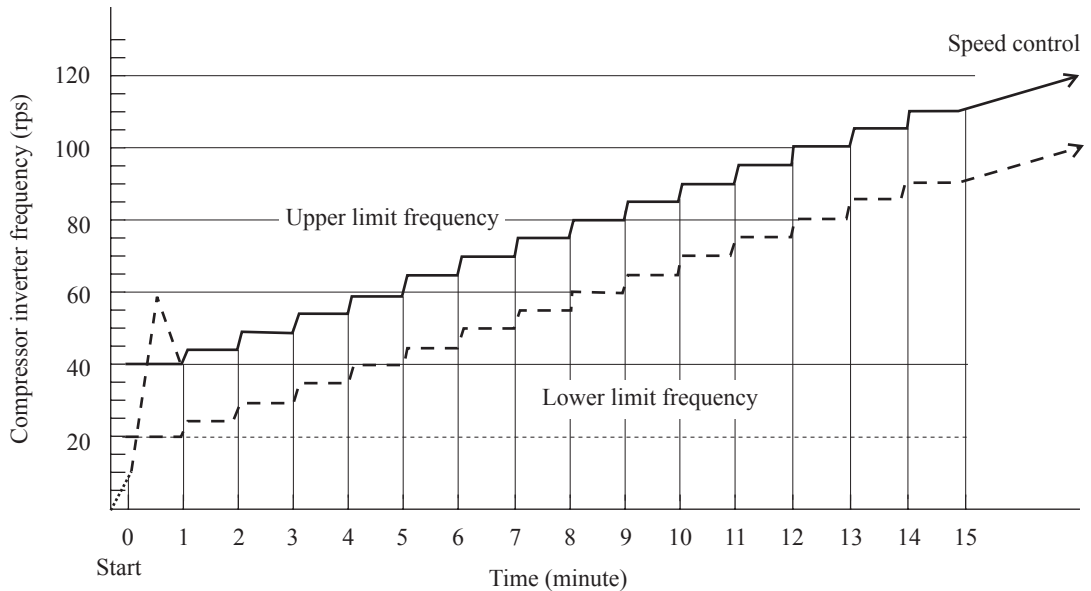

(iii) Compressor protection start B

< Control contents >

- ① Compressor maintains operation at lower limit frequency, after 4-way valve switching safeguard ends.
 If the time from starting till reaching the lower limit frequency after 4-way valve switching safeguard operation has elapsed 2 minutes, the target frequency is changed to that of 2 minutes later from the lower limit frequency.
- ② For 18 minutes after starting, the target frequency is increased at a rate of 5 rps/2 minutes from the lower limit frequency.
- ③ For 18 minutes after starting, the starting point of this control is the completion point of inverter start (10 rps).
- ④ From 18 minutes to 24 minutes, it is increased at a rate of 5 rps/minute.

< Ending conditions >

When either one of the following conditions is established

- a) This frequency-up control will end when the cumulative operation time after starting becomes 24 minutes.
 If the inverter stopped within 24 minutes after starting and starts again, it starts with "Compressor protection start, normal" and increases the frequency at a rate of 5 rps/minute till the cumulative operation time after starting becomes 24 minutes.
 However, if 45 minutes have been elapsed since inverter stopped and starts again, it starts with "Compressor protection start A".

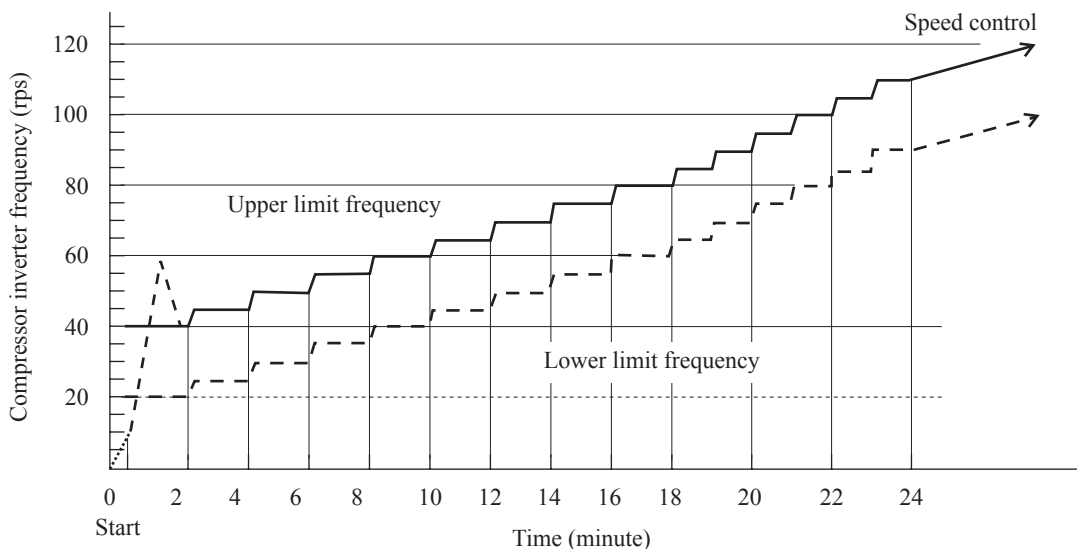

(4) Outdoor fan control

(a) Outdoor fan speed and fan motor rotation speed.

The 7th outdoor fan speed in the following table is specified as the rated speed. Under the normal control, the speeds up to 8th level (800 min⁻¹) are used.

Outdoor fan tap	Cooling		Heating	
	FMo1 [min ⁻¹]	FMo2 [min ⁻¹]	FMo1 [min ⁻¹]	FMo2 [min ⁻¹]
0th speed	0	0	0	0
1st speed	200	0	200	0
2nd speed	200	200	200	200
3rd speed	300	300	300	300
4th speed	400	400	400	400
5th speed	500	500	500	500
6th speed	575	575	575	575
7th speed	740	740	740	740
8th speed	800	800	800 (780)	800 (780)

Note (1) Figures in the parentheses in the above table are applicable to FDC224KXZME1.

(b) Fan control during cooling

During cooling and dehumidifying, fan speed is controlled in accordance with the high pressure (sensed by PSH) and the outdoor air temperature (sensed by Tho-A).

(i) Initial fan speeds are as follows.

Initial outdoor fan speed at cooling

Model	Outdoor air temp. ≤ 10°C	10°C < Outdoor air temp. < 15°C	15°C ≤ Outdoor air temp.
All models	2nd speed	4th speed	6th speed

(ii) During normal operation, the speed is changed in accordance with the high pressure value.

- ① When it has detected $HP \geq 2.2$ MPa for 1 minute continuously, the fan speed is raised by one tap.
- ② When it is $1.5 \text{ MPa} < HP < 2.2 \text{ MPa}$, the present fan speed is maintained.
- ③ When it has detected $HP \leq 1.5$ MPa for 1 minute continuously, the fan speed is dropped by one tap.
- ④ Control range of fan speed is 1th – 8th speeds.

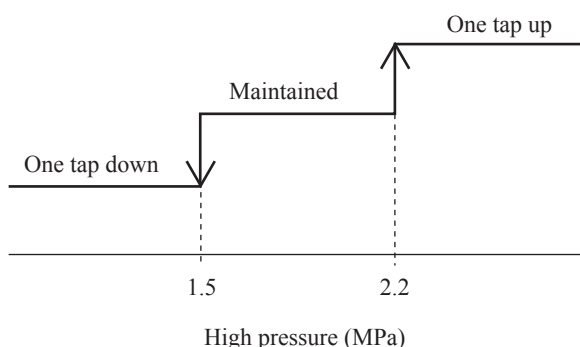

(iii) When states under this control change from $HP < 3.3$ MPa to $HP \geq 3.3$ MPa, the fan speed is changed preferentially to the followings. (After the change it returns to the normal control.)

- ① When the outdoor air temperature $\geq 30^\circ\text{C}$, it changes to 7th or higher speed.
- ② When the outdoor air temperature $< 30^\circ\text{C}$, it changes to 3th or higher speed.
- ③ When the fan speed was higher than the above before the change of states, the fan speed is not changed.

(c) Outdoor fan cooling control at low outdoor air temperature

(i) Starting conditions

This control is performed when all of following conditions is established.

- ① When the ordinary outdoor fan control is performed
- ② Outdoor air temperature $\leq 10^{\circ}\text{C}$ (It is reset with the hysteresis of the outdoor air temperature $> 15^{\circ}\text{C}$.)

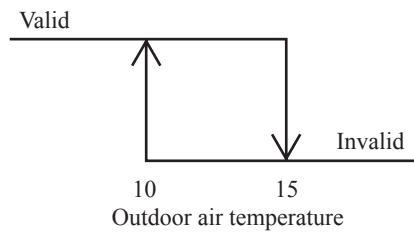

③ Outdoor fan speed = 1st speed (200 min^{-1})

(ii) Control contents

- ① Initial fan speed is 200 min^{-1}
- ② If the following high pressure is detected for 20 seconds continuously, fan speed will be changed

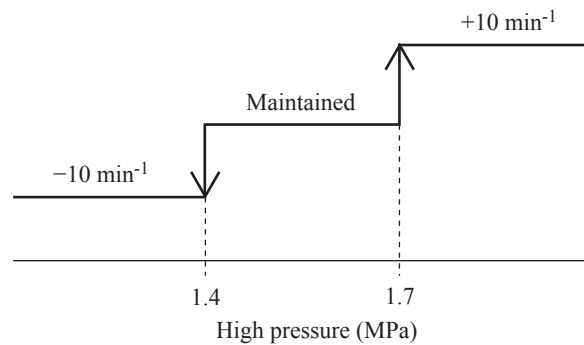

③ Outdoor fan speed is in a range of $130 \text{ min}^{-1} - 300 \text{ min}^{-1}$.

(iii) Ending conditions

When either one of following conditions is established

- ① When the ordinary outdoor unit fan cooling control ends
 - ② Outdoor air temperature $> 15^{\circ}\text{C}$
 - ③ Outdoor fan speed ≥ 2 th speed
- (Note) This control range is not more than $300 \text{ min}^{-1} \times 1 \text{ fan}$.

(d) Outdoor fan heating control

The fan speed control is performed based on the low pressure (detected with PSL) during heating operation.

(i) Initial fan speed is 6th speed.

(ii) Speed is changed depending on the low pressure value.

- ① When it is detected $\text{LP} \leq 0.75 \text{ MPa}$ for 30 seconds continuously, the fan speed is raised by 1 tap.
- ② When it is $0.75 \text{ MPa} < \text{LP} < 0.85 \text{ MPa}$, the present fan speed is maintained.
- ③ When it is detected $\text{LP} \geq 0.85 \text{ MPa}$ for 30 seconds continuously, the fan speed is dropped by 1 tap.
- ④ Control range of fan speed is 1st – 8th speeds.

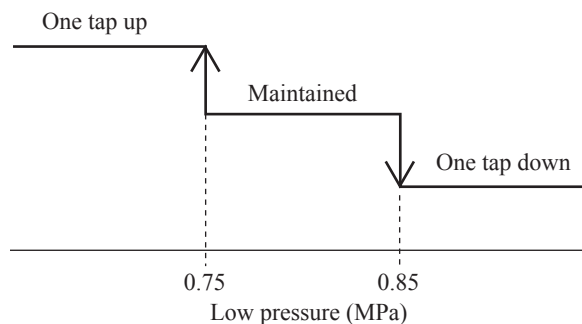

(iii) When states change from $\text{LP} < 1.0 \text{ MPa}$ to $\text{HP} \geq 1.0 \text{ MPa}$ during this control, the fan speed is changed preferentially to the following. (It returns to the normal control after the change.)

- ① It changes to 4th or lower speed.
- ② If the fan speed was lower than the above speed before the change of states, the fan speed does not change.

(5) Defrost control

(a) Temperature condition of defrost operation

(i) Starting conditions (Standard specification or cold region specification can be selected by switching the jumper wire J15.)

Defrost operation will start, when outdoor unit whose compressor is operating under heating mode has satisfied all the following conditions.

- 1) When 33 minutes of cumulative compressor operation time has passed since heating operation started.
- 2) When 33 minutes of cumulative compressor operation time has passed since the previous defrost operation ended.
- 3) When 8 minutes has passed since the compressor turned ON from OFF status.
- 4) When 8 minutes has passed since one outdoor fan turned ON from OFF status.
- 5) After all above conditions have been met, when any of the following conditions is satisfied
 - ① When the outdoor heat exchanger temperature (sensed by Tho-R) and the outdoor air temperature (sensed by Tho-A) dropped below the defrost operation start temperature in Fig. 1 for 30 seconds continuously.
 - ② When the suction pressure saturated temperature calculated by the low pressure (sensed by PSL) and the outdoor air temperature (sensed by Tho-A) dropped below the defrost operation start temperature in Fig. 2 for 3 minutes continuously

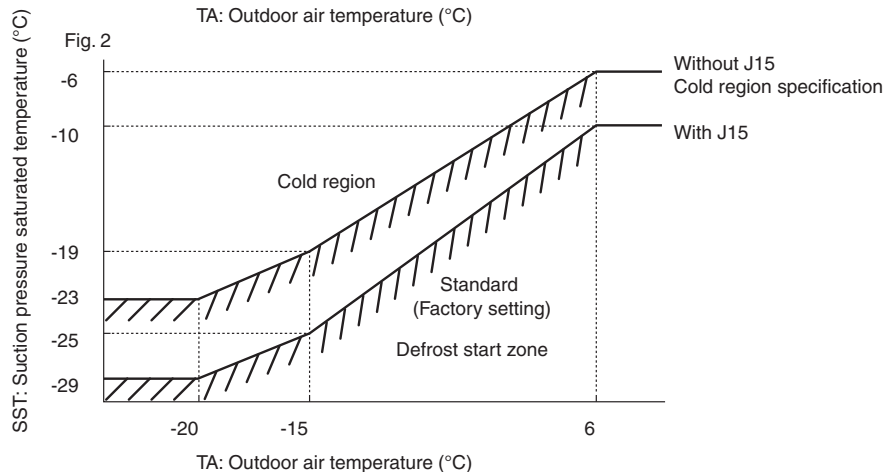
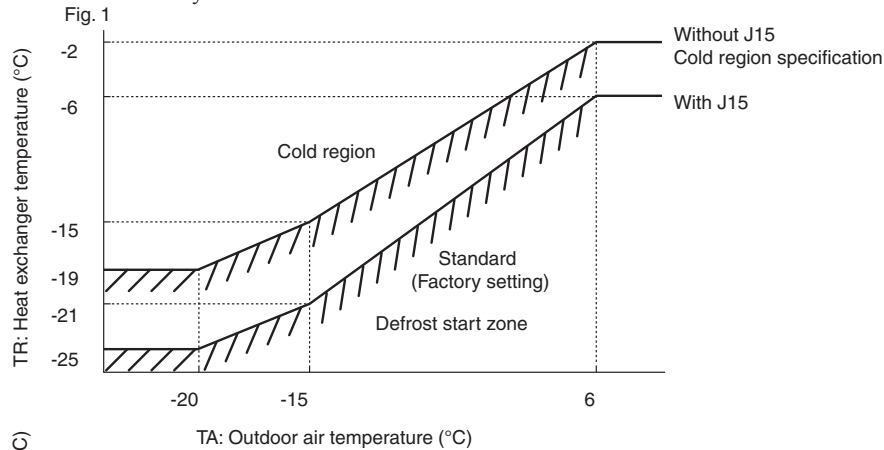

(ii) Ending conditions

Defrost operation stops when any of the following conditions is satisfied

- 1) When 12 minutes has passed since defrost operation started
- 2) When the outdoor heat exchanger temperature (sensed by Tho-R) is detected 10°C or higher continuously for 10 seconds
- 3) When it has detected the high pressure (HP) $\geq 3.0\text{MPa}$

(b) Time condition of defrost operation

(i) Starting conditions

Defrost operation start when all of the following conditions are satisfied

- 1) When 33 minutes of cumulative compressor operation time has passed since heating operation started.
- 2) When 33 minutes of cumulative compressor operation time has passed since the previous defrost operation ended.
- 3) When 105 seconds has passed since the compressor turned ON from OFF status in heating mode.
- 4) When the oil return condition has been established
- 5) Following cases are excluded.

① When the upper limit frequency of the compressor protection start A or B is lower than the defrost frequency

② During the normal compressor protection start

(ii) Ending conditions

Defrost operation stops when any of the following conditions is satisfied

- 1) When 12 minutes has passed since defrost started
- 2) When the outdoor heat exchanger temperature (sensed by Tho-R) is detected 10°C or higher continuously for 10 seconds
- 3) When it has detected the high pressure (HP) $\geq 3.0\text{MPa}$

(6) Protective control

(a) Discharge pipe temperature (Td) control

Discharge pipe temperature sensor (Tho-D1) monitors the discharge pipe temperature (Td) to avoid the rise of discharge pipe temperature.

(i) Compressor capacity control

1) Starting conditions

When all of following conditions are satisfied

- ① When the compressor is ON state.
- ② When it detects the discharge pipe temperature (sensed by Tho-D1) is higher than 120°C

2) Control contents

Whenever it detects the discharge pipe temperature is higher than 120°C for 5 seconds, the capacity is decreased.

3) Ending conditions

When any of the following conditions is satisfied

- ① When the discharge pipe temperature (sensed by Tho-D1) drops below 110°C
- ② When the compressor is OFF state.
- ③ During the defrost operation

(ii) Indoor EEV slightly open control at heating stop

Rise of discharge pipe temperature (Td) is restrained by opening the indoor EEV during heating stop.

(b) Over-current protection control (Current safe)

- (i) If the input current value at the inverter inlet (converter inlet L3-phase) exceeds the setting value, the compressor speed is reduced. If the higher value persists even after the speed reduction, the speed is reduced further.
- (ii) This control terminates when it is lower than the reset value for 3 minutes continuously or lower than the setting value for 6 minutes continuously.

(c) Power transistor temperature (PT) protective control

If the power transistor temperature exceeds 75°C, the compressor speed is controlled.

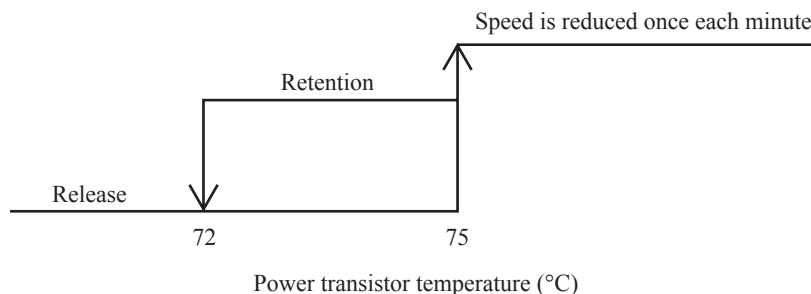

(7) Test run

(a) Starting conditions

- (i) Turn ON the test run switch (SW5-1). The switch is invalid if it is turned ON before the power ON.
- (ii) Pump down switch (SW5-3) must be turned OFF.

(b) Contents of control

(i) Turning ON the dip switch (SW5-2) conducts cooling operation and turning OFF (SW5-2) conducts heating operation.

1) Cooling operation

Compressor operation frequency control is conducted by the cooling low pressure control.

2) Heating operation

Compressor operation frequency control is conducted by the heating high pressure control.

(ii) Test run start signal under corresponding operation mode is transmitted to all indoor units connected.

(c) Ending conditions

- (i) When the test run switch (SW5-1) is turned OFF, it stops.
- (ii) When it has stopped anomalously by the error control during test run, the error is displayed in the same way as the case of normal operation and the state of anomalous stop is kept ON even if the test run switch (SW5-1) is turned OFF.

(B) Option controls**• Functions of outdoor PCB connector CnS1, CnS2, CnG1, CnG2 and CnZ1**

- ① CnS1 connector : By changing the allocation of external input functions [P07-“X”] on the 7-segment, following functions can be selected.

Function No. “X”	CnS1 short circuited	CnS1 open
“0” : External operation input	Operation permission	Operation prohibition
“1” : Demand input	Invalid	Valid
“2” : Forced cooling / heating input	Heating	Cooling
“3” : Silent mode input 1	Valid	Invalid
“4” : Oil return control input	ON	OFF
“5” : Outdoor fan snow guard control input	Valid	Invalid
“6” : Test run external input 1	Test run start	Normal operation
“7” : Test run external input 2	Cooling test run	Heating test run
“8” : Silent mode input 2	Valid	Invalid
“9” : 2-step demand input	Invalid	Valid

* [P07] for CnS1, [P08] for CnS2, [P09] for CnG1 and [P10] for CnG2

- ② CnZ1 connector : By changing the allocation of external output functions [P06-“X”] on the 7-segment, following functions can be selected.

“0” : Operation output
“1” : Error output
“2” : Compressor ON output
“3” : Fan ON output
“4” : Oil return operation output
“5” : High pressure control output for activating splaying system
“6 – 9” : Spare

(1) External input and demand input

(a) Operation permission or prohibition modes

Note (1) With 7-segment display [P07]-[0] (CnS2:[P08]-[0], CnG1:[P09]-[0] and CnG2[P10]-[0] can be used as well.)

- (i) Operation permission or operation prohibition mode is switched with the connector (CnS1) and the jumper wire (J13) on the outdoor PCB.

J13: Switching of CnS1 input method

J13 short-circuited: CnS1 is for the level input.

J13 open: CnS1 is for the pulse input.

- (ii) Operation permission/prohibition control by the external input CnS1 of outdoor unit

Input: CnS1	Switching with J13	CnS1: Switching of operation permission/prohibition modes
	Short-circuit (Level input)	Operation prohibition mode → Operation permission mode
	Open (Pulse input)	Switching of operation permission/ operation prohibition modes (Reversal)
	Short-circuit (Level input)	Operation permission mode → Operation prohibition mode
	Open (Pulse input)	(NOP)

Note (1) Factory setting – J13: Short-circuit, CnS1: Short-circuit (Short-circuit pin connected)

- (iii) The operation condition is displayed on the LCD of remote control and is transferred to option central control.
- (iv) When the control comand from remote control is not accepted (Under the condition of the system all stop status by external input), “Center” is dispalyed. See Item 5) mentioned below.
- (v) CnS1 performs the following operations depending on the short-circuit or open of thjumper wire (J13). In case of pulse input, the pulse width is 500ms or larger.

① J13 – Short-circuit

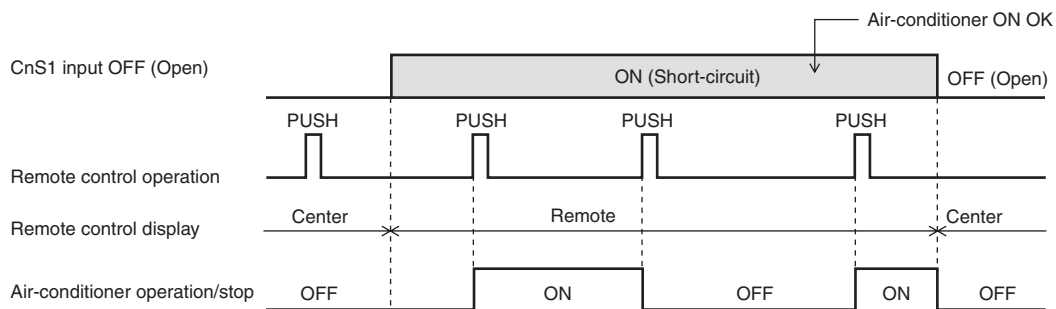

② J13 - Open

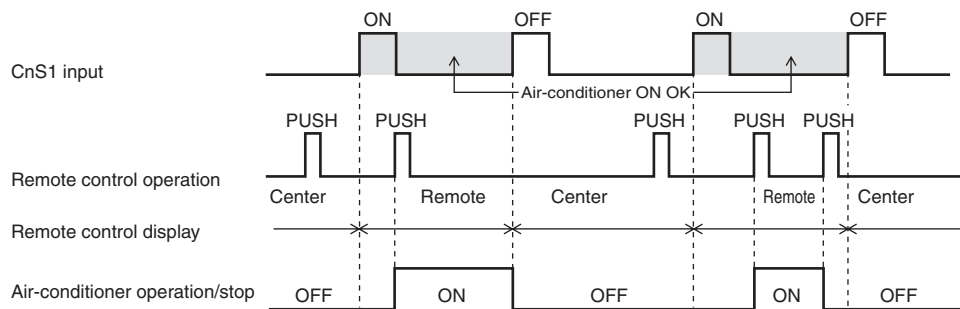

(b) Demand control

Note(1) With 7-segment display [P07] = [1] (CnS2:[P08]-[1], CnG1:[P09]-[1] and CnG2[P10]-[1] can be used as well.)

- (i) Demand control and normal operation are switched with the connector (CnS2) and the jumper wire (J13) on the outdoor PCB.

J13: Switching of CnS2 input method

J13 short-circuit: CnS2 is for the level input

J13 open: CnS2 is for the pulse input

(ii) Operation/ stop control by the demand input CnS2 of outdoor unit

Input: CnS2	Switching with J13	CnS2: Switching of demand control/ normal operation
	Short-circuit (Level input)	Demand control → Normal operation
	Open (Pulse input)	Switching of normal operation/ demand control (Reversal)
	Short-circuit (Level input)	Normal operation → Demand control
	Open (Pulse input)	$\overline{\text{NOP}}$

Note (1) Factory setting – J13: Short-circuit, CnS2: Short-circuit (Short-circuit pin connected)

(iii) The operation condition is displayed on the LCD of remote control and is transferred to option central control.

(iv) Demand control

Demand ratio can be switched with the dip switches (SW4-5, 4-6) on the outdoor PCB.

SW4-5, SW4-6 demand switching: 0 – Open, 1 – Short-circuit (Factory default is open)

SW4-5	SW4-6	Compressor Output (%)
0	0	80
1	0	60
0	1	40
1	1	0

(v) CnS2 performs the following operations depending on the short circuited or open of the jumper wire (J13).

In the case of pulse input, the pulse width is 500ms or larger .

① J13 – Short-circuit

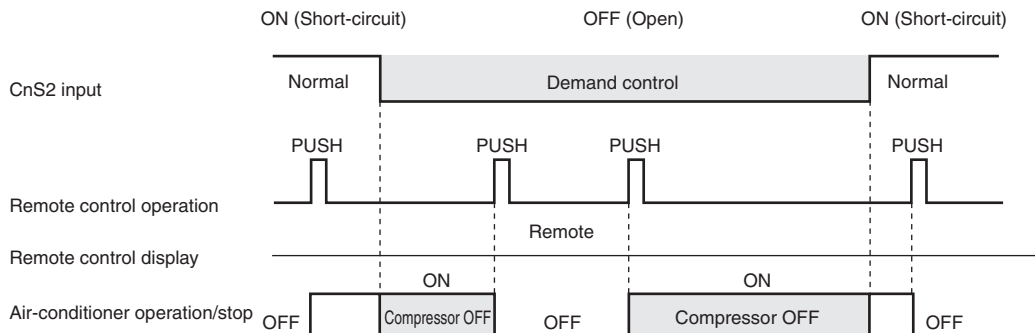

② J13 - Open

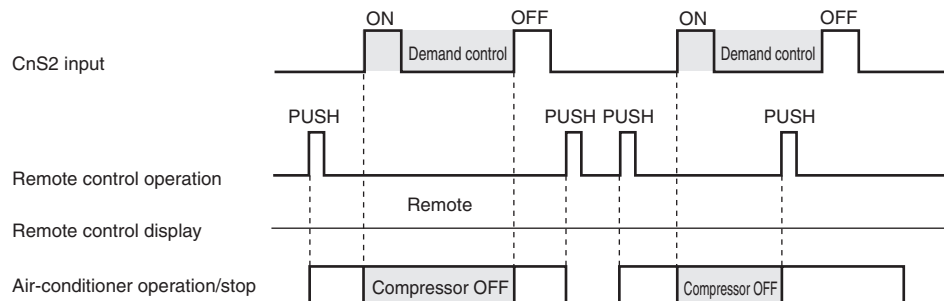

(c) 2-step demand control

- (i) Starting condition
 - If all the following conditions are satisfied.
 - 1) 7-segment display [P04] is set 0%, 40%, 60% or 80% (except OFF).
 - 2) Demand control is in operation.
 - 3) External input connector of outdoor unit for "2-step demand control" is valid.
 - Ex. "2-step demand input" is valid, when connector (CnS2:[P08]-[9]*) is open.
 - * CnS1:[P07]-[9], CnG1:[P09]-[9] and CnG2:[P10]-[9] can be used, if they are not in use.
- (ii) Contents of control
 - Same as the energy saving mode control. [Refer to item (5) on page 41]
- (iii) Ending condition
 - If the start condition is not established.

Energy saving mode control : Not depending on external input, compressor speed is limited by the setting of 7-segment display [P04]

Demand control : When external input is ON, compressor speed is limited. Demand % is set with the dip switches SW4-5 and SW4-6.

2-step demand control : When external input is ON, compressor speed is limited. Demand % is set with the 7-segment display [P04].

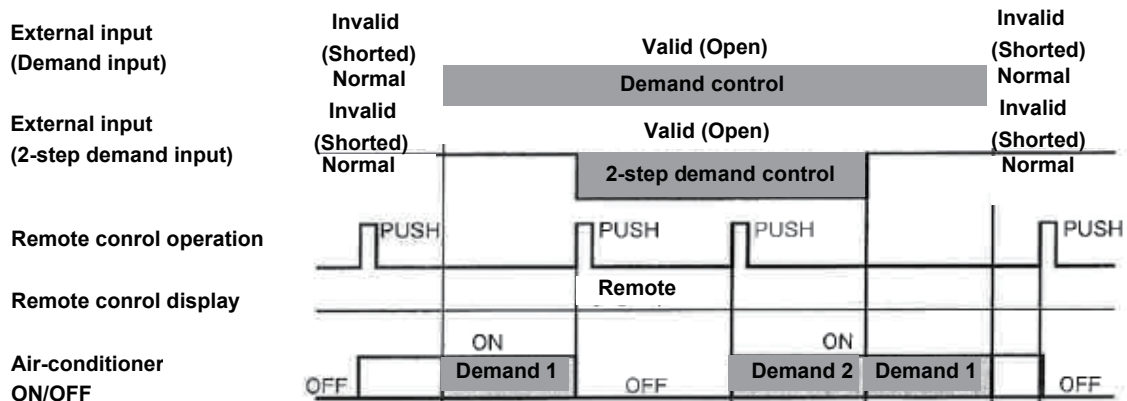

Demand 1: Demand control is done by the compressor output % set with SW4-5 and SW4-6.

Demand 2: Demand control is done by the compressor output % set with [P10].

(d) Demand control from indoor unit

- (i) Starting condition
 - ① When a demand ratio (“80%”, “60%”, “40%” or “0%”) has been transmitted from an indoor unit of “Peak-cut timer” function.
 - ② Normal demand of Item (b) is not activated.
 - ③ This control is performed on the RC-EX3A remote control.
- (ii) Contents of control
 - ① Compressor’s upper limit speed is restricted according to the demand restriction rate.
 - ② The demand ratio controlled by the restriction rate which is transmitted from an indoor unit.
 - ③ If the demand control rate signals are received from two or more indoor units, the control takes the lowest rate.
 - ④ When the demand rate is other than 0%, this control is superseded by the controls of 4-way valve safeguard, defrost operation, oil return operation, oil equalized operation, pump-down operation for replacement, Start/Stop pump-down operation and check operation.
- (iii) Ending condition
 - When the starting conditions have been lost.

(2) Silent mode control

(a) Starting conditions

When all of the following conditions is established

- (i) At the start of silent mode initiated by the indoor unit or when the silent mode input is made effective (short-circuited) at the external input terminal (Factory default: CnG2) on the outdoor unit
- (ii) When the outdoor unit operation mode is cooling or heating
- (iii) When the outdoor air temperature satisfies the following condition
 - 1) Silent setting 0, 1: Effective in zone A and B
 - 2) Silent setting 2, 3: Effective in zone B

Note (1) Silent setting 0 to 3 can be switched by [P05] of 7-segment display

<Outdoor operation mode - Cooling>

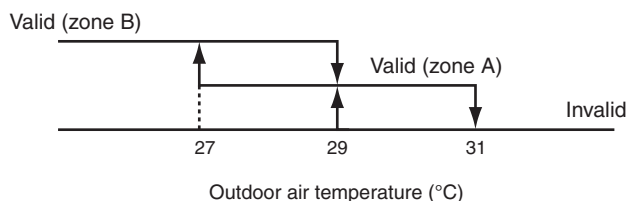

<Outdoor operation mode - Heating>

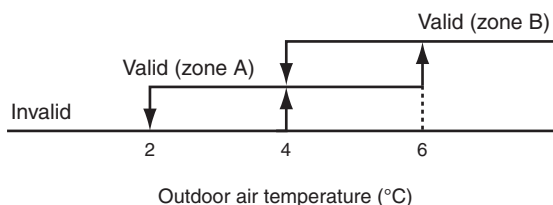

- (iv) It is excluded when the following invalid conditions are established

(For prevention of anomalous pressure rise at start)

- For 30 seconds after either compressor has been turned ON
- (During a special operation)
- During the 4-way valve switching safeguard
- During the defrost operation
- During the oil return control
- During the moved pump down control
- During the pump down control for removal of the unit

Note (1) Any controls affected by the restriction of compressor and outdoor fan capacity during the silent mode are excluded.

(b) Sound level (Reference data)

Model	SPL Sound pressure level for cooling	SPL Sound pressure level for heating	SPL Silent mode setting 0	SPL Silent mode setting 1	SPL Silent mode setting 2	SPL Silent mode setting 3
	dB(A)	dB(A)	dB(A)	dB(A)	dB(A)	dB(A)
FDC224KXZME1	58	59	59	57	52	49
FDC280KXZME1	60	60	60	58	53	51
FDC335KXZME1	60	60	60	58	53	51

Model	PWL Sound power level for cooling	PWL Sound power level for heating	PWL Silent mode setting 0	PWL Silent mode setting 1	PWL Silent mode setting 2	PWL Silent mode setting 3
	dB(A)	dB(A)	dB(A)	dB(A)	dB(A)	dB(A)
FDC224KXZME1	73	75	73	71	66	63
FDC280KXZME1	75	76	74	72	67	65
FDC335KXZME1	75	76	74	72	67	65

(c) Ending condition

- When the starting conditions are not established

(3) Outdoor fan snow protection control

(a) This control is enabled/disabled by entering data into 7-segment display.

(b) Setting method of outdoor fan control

[Starting conditions]

When following conditions are established for 10 minutes continuously.

- (i) Snow protection control setting is valid ([P02]-1) and outdoor air temperature < 3°C or external input of outdoor fan snow protection control ON. ([P07]-5 and CnS1 is shorted)
 - ① Set the Code No. to “P02”.
 - ② “0” or “1” is displayed at the data display area.
 “0”: Outdoor fan control disabled (Factory setting)
 “1”: Outdoor fan control enabled
 - ③ Press SW7 (Data write/delete) for 3 seconds continuously.
 - ④ “0” or “1” blinks every 0.5 second at the data display area.
 - ⑤ Press SW8 (one digit) to toggle the display back and forth between “0” and “1” (blinking).
 - ⑥ If SW7 is pressed for 3 seconds or longer continuously while “0” and “1” is blinking, the blinking stops.
 With this operation, the enabled/disabled setting of outdoor fan control is stored in memory of EEPROM, and henceforth the outdoor fan is controlled according to the contents of memory.
 - ⑦ Contents of the outdoor fan control are retained even if the power is turned off and backed on again.

(c) Contents of outdoor fan snow protection control

- ① If the outdoor air temperature drops 3°C or lower when the unit is all stop or error stop, the outdoor fan runs at the rating speed (7th speed) once every 10 minutes.
- ② The outdoor fan runs for 30 seconds.*
*Operation time outdoor fan is changeable from 10 to 600 seconds by [P03]
- ③ During this snow protection control, the compressor’s magnetic contactor (52X1 52X2) is ON.

(d) Ending conditions of outdoor fan snow protection control

When following conditions are established.

- (i) Snow protection control setting is invalid ([P02]-0) or outdoor air temperature > 5°C and external input of outdoor fan snow protection control OFF ([P07]-[5]and CnS1is open).
- (ii) Compressor ON
- (iii) During all stop by anomaly
 <Outdoor air temperature condition at snow protection control>

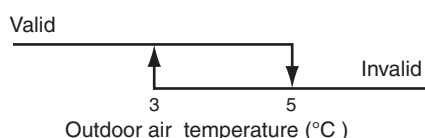

(4) External output

This function is used in order to operate the external option devices in conjunction with relay outputs of the respective operation information from outdoor unit.

[External output function]

External output function of CnZ1 can be switched by changing of [P06] on 7-segment display as mentioned below.

0: Operation output

- When the outdoor unit operation mode is “Operation”, the external output relay is turned ON.
Note (1) The “Operation” includes not only compressor ON mode but also Fan mode and thermostat OFF mode under the condition of remote control ON. But the anomalous stop is excluded.

1: Error output

- It is turned ON at anomalous stop, and turned OFF when “CHECK” and “RESET” buttons on remote control are pressed simultaneously after recovering from the anomaly. Even if “CHECK” and “RESET” buttons are pressed before recovering from the anomaly, it is not turned OFF, but when recovering from the anomaly later, it is automatically turned OFF.

2: Compressor ON output

- It is turned ON when the compressor is ON.

3: Fan ON output

- It is turned ON when the outdoor fan speed command > 0.

(5) Energy saving mode control

This control is effective, when [P04] of 7-segment display is set 000, 040, 060, 080 (except OFF)

(a) Control contents

- (i) Compressor upper limit speed is changed according to the setting ratio.
- (ii) Compressor upper limit speed is obtained by multiplying the rating speed (at cooling/heating) with the setting ratio as follows.
 - OFF: Normal (Factory setting)
 - 80%: 80% of rating compressor upper limit speed
 - 60%: 60% of rating compressor upper limit speed
 - 40%: 40% of rating compressor upper limit speed
 - 0%: 0% of rating compressor upper limit speed (stop)
- (iii) Except 0% of energy saving ratio, the following controls take precedence over this control.
 - 4-way valve switching safeguard
 - Defrost operation
 - Oil return control
 - During the pump down control for removal of the unit
 - Pump down control at start/stop

(6) Forced cooling/heating operation

- (a) **With this control, SW3-7 on the outdoor PCB is turned ON and CnG1 (equipped with short circuit pin) is shorted or opened so as to forcibly determined whether the indoor unit is operated for cooling or heating.**
- (b) **If any operation mode other than the forcible mode is commanded from indoor unit, the mode unmatched message is displayed on the remote control or others and operation enters in the FAN mode.**

SW3-7	CnG1	Operation
ON	Open	Cooling only
	Close	Heating only

(7) Emergency stop control

When one of indoor units receives the emergency stop signal from option device like as refrigerant leakage detector and the information is transmitted to the outdoor unit, the outdoor unit stops operation and an emergency stop error is transmitted to all indoor units running.

Make the emergency stop effective by remote control indoor function setting.

- (a) **When it receives the “Emergency stop” command from the indoor unit, it makes all stop by error.**
- (b) **It shows the Error display “E63” and transmits the “Emergency stop” command to all indoor units.**
- (c) **If the “Emergency stop reset” command is received from the indoor unit, the “Emergency stop reset” command is transmitted to all indoor units.**

(8) Pump down operation control for removal of the unit

When an outdoor unit is discarded or removed, the pump down control is performed at the outdoor unit side in order to recover the refrigerant quickly to the outdoor unit.

(a) Starting conditions

This is implemented with the liquid service valve closed.

- (i) Outdoor unit operation mode – Stop
- (ii) Turn ON the test run cooling switch SW5-2 (cooling).
- (iii) Turn ON the pump down switch SW5-3 (pump down).
- (iv) Turn ON the test run switch SW5-1 when the above (i)-(iii) statuses are satisfied.

Note (1) Input before the power ON is invalid.

(b) Control contents

- (i) Compressor starts under compressor start protection control and runs at target speed of pump down operation. However, when the operation starting conditions have been established during the 3-minute delay control of compressor, the compressor starts after completing the 3-minute delay control.

Model \ Item	HP	Target compressor speed at pump down operation
FDC224KXZME1	8	50rps
FDC280KXZME1	10	62rps
FDC335KXZME1	12	52rps

- (ii) As the starting conditions are established, both red LED and green LED on the outdoor PCB flash continuously. 7-segment display shows “PdS” (Channel 0) at the code display area.
- (iii) During the pump down operation control, the protective controls (excluding low pressure protective control, anomalous low pressure control and pressure ratio protection control) and the error detection control are effective.
- (iv) The sub-cooling coil expansion valve (EEVSC) closes fully during the pump down control.

(c) Ending conditions

If any of the following conditions is satisfied, this control ends

- (i) If a low pressure (LP) $\leq 0.01\text{MPa}$ is detected for 5 seconds continuously, it ends normally and initiates the followings.
 - ① Red LED: keeps lighting
 - ② Green LED: keeps flashin
 - ③ 7-segment display: PdE
 - ④ Remote control: Stop
- (ii) Anomalous all stop by the error detection control
- (iii) If the cumulative compressor operation time under the pump down control totals 15 minutes (ending by time count up), it stops and initiates the following.
 - ① Red LED: stays OFF
 - ② Green LED: keeps flashin
 - ③ 7-segment display: No display
 - ④ Remote control: Stop
- (iv) When any of setting switches (SW5-1, SW5-2 and SW5-3) has been turned OFF during pump down.

Note (1) Even if only the pump down switch SW5-3 is turned OFF, it does not recognized as the cooling test run mode , but stops.

(9) Outdoor operation mode

On the standard models of 2 pipe system, the outdoor operation mode of Stop/Cooling/Heating is selected based on the information of indoor units, and then respective controls are performed.

<Contents of control>

(a) Determination of outdoor operation mode

Operation mode of outdoor unit is determined based on respective signals of Operation/Stop and Cooling/Heating.

(b) Type of outdoor operation mode

- (i) Outdoor operation mode - Stop
- (ii) Outdoor operation mode - Cooling
- (iii) Outdoor operation mode - Heating

(c) Priority in operation mode selection.

- (i) First priority is given to the forced cooling/heating operation.
- (ii) Second priority is given as follows

Priority in the operation mode selection can be changed using the 7-segment setting [P01].

P01 setting	Mode
0 (Factory default)	First unit's operation mode
1	Last unit's operation mode
2	Priority of master unit's setting operation mode
3	Priority of required major operation mode

- First unit's operation mode: Operation mode of the indoor unit which is operated first time after stop of the outdoor unit operation mode
- Last unit's operation mode: Operation mode of the indoor unit which is operated at the last time
- Priority of master unit's setting operation mode: Operation mode of indoor unit of which the address No. is smallest (Master indoor unit). When the master indoor unit is turned off, it become valid the first push priority on other indoor units' remote controls.
- Priority of required major operation mode: Operation mode of which the total capacity of operating indoor units is larger. There is no renewed judgment for 10 minutes after a change on the operation mode.
The judgment, however, is renewed in following cases.
 - At the stop
 - When the P01 setting is changed.

(iii) In the event that agreement of operation mode is lost between indoor units and outdoor units by selecting the first or second priority after determining the operation mode, it is changed forcibly to the "Fan" mode. The operation mode LCD flickers to warn the "Mode unmatched".

(iv) Example of operation mode selection

<First unit's operation mode>

① If both of indoor units 0 and 1 have the same operation mode, it operates with the mode.

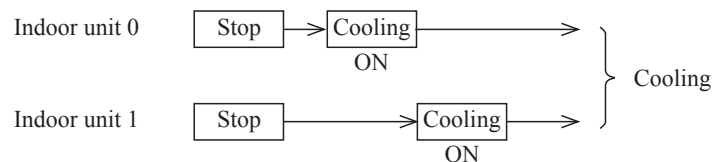

② Cooling does not match on indoor units 0 and 1 (Priority is given to previous operation.)

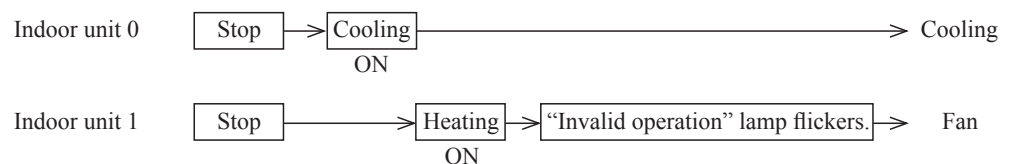

③ When it is changed from same mode to unmatched.

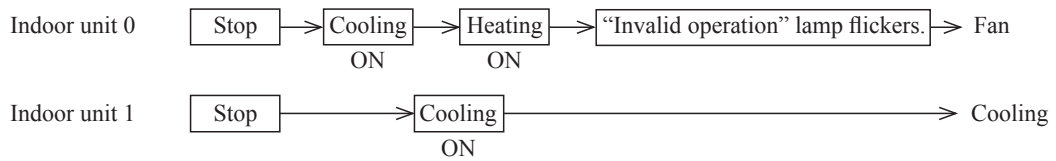

④ Operation mode is prepared for change in the fan mode.

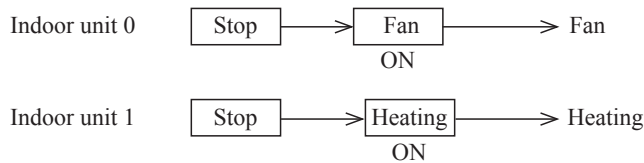

<Last unit's operation mode>

① If the indoor unit 1 of which operation mode is different has joined in when the indoor units 0 is operating.

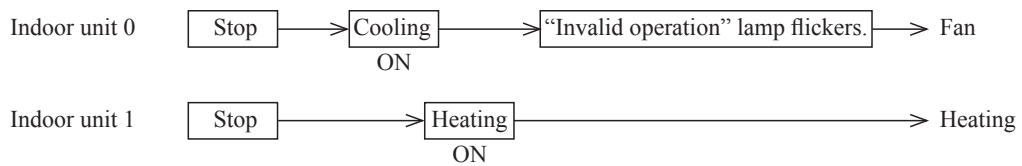

<Priority of required major operation mode>

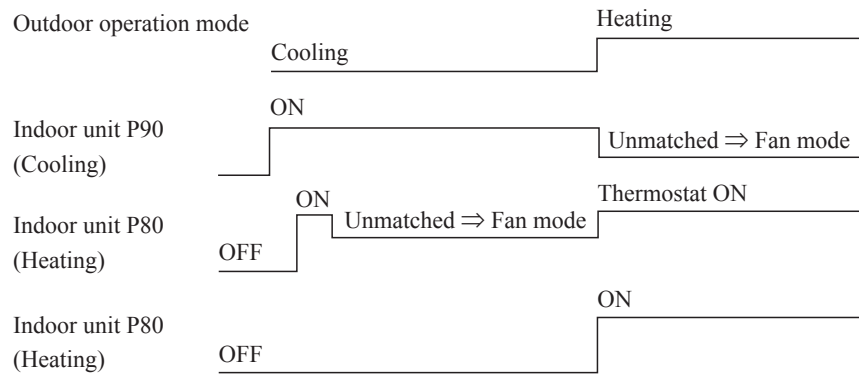

(v) Reset of unmatched condition (Cooling/heating unmatched)

When unmatched occurs among indoor units, it can be reset by either one of followings.

- ① If the operation mode of outdoor unit is matched with that of indoor unit.
- ② If the operation mode is changed to "Fan" or "Stop" on the indoor units on which Cooling/heating is unmatched.

(d) Forced cooling /heating operation (Master unit)

Note (1) Following explanation is based on using CnG1 terminal and setting function [P09]-[2] with 7-segment display.

However other terminals can be used with following function setting of 7-segment display.

CnS1: [P07]-[2] CnS2: [P08]-[2] CnG2: [P10]-[2]

- (i) When SW3-7 on the outdoor control PCB is turned ON after setting function [P09]-[2] with 7-segment display, if CnG1 is shorted, forced heating operation is performed, but if CnG1 is open, forced cooling operation is performed.
- (ii) If the different mode from the forced operation mode is commanded from indoor unit, the "mode unmatched" message is displayed on the LCD of remote control and the operation is entered in FAN mode.

SW3-7	ON	CnG1	Open	Operation in cooling only
			Shorted	Operation in heating only
	OFF		Normal operation	

- (iii) With the forced mode from indoor unit, if a different operation mode is commanded, following operations take place based on the forced cooling/heating operation set with the 7-segment [P38].

P38 = 0: The operation mode unmatched is displayed on the remote control, etc., and it is changed to the fan operation.

P38 = 1: It is operated with the forced cooling/heating operation mode.

Setting temperature for cooling ... 28°C

Setting temperature for heating ... 20°C

(10) Pump-down operation by external input

If an error stop is raised by an external input by refrigerant leaking alarm unit, the pump-down operation is performed at the outdoor unit side in order to prevent the refrigerant from leaking.

They are local arrangements.

- ① Refrigerant leaking alarm unit
- ② Valve to shut liquid pipe
- ③ Valve to shut gas pipe

Valves of ② and ③ should be selected what the pressure loss of refrigerant piping doesn't increase.

(a) Status 1: Pump-down operation

(i) Starting condition

- ① When the external input function is assigned to "0: External operation input" and the external input terminal is open (by refrigerant leaking alarm unit).
- ② If the pump-down control is valid when the error stop is raised by the setting on 7-segment. ([P77] = "1")

(ii) Contents of control

- ① ON is output on CnY, and the liquid service valve is shut down if it is connected on CnY.
- ② The pump-down operation for replacement is performed.

(iii) Ending condition

- ① When starting conditions are lost.
- ② When the pump-down operation has ended.

(b) Status 2: Emergency stop operation

(i) Starting condition

- ① When the pump-down operation has ended in the status 1.

(ii) Contents of control

- ① ON is output to CnZ1, and the gas service valve is shut down if it is connected on CnZ1.
- ② Operation stops with the error full stop. ([E63] is displayed.)

(iii) Ending condition

- ① When starting conditions for the status 1 are lost.
- ② State of error continues for 3 minutes after the error full stop. It cannot be reset in this condition from the remote control. If the starting conditions for Status 1 are not yet established later, this can be reset by the remote control inspection reset.

● Pump down by external input

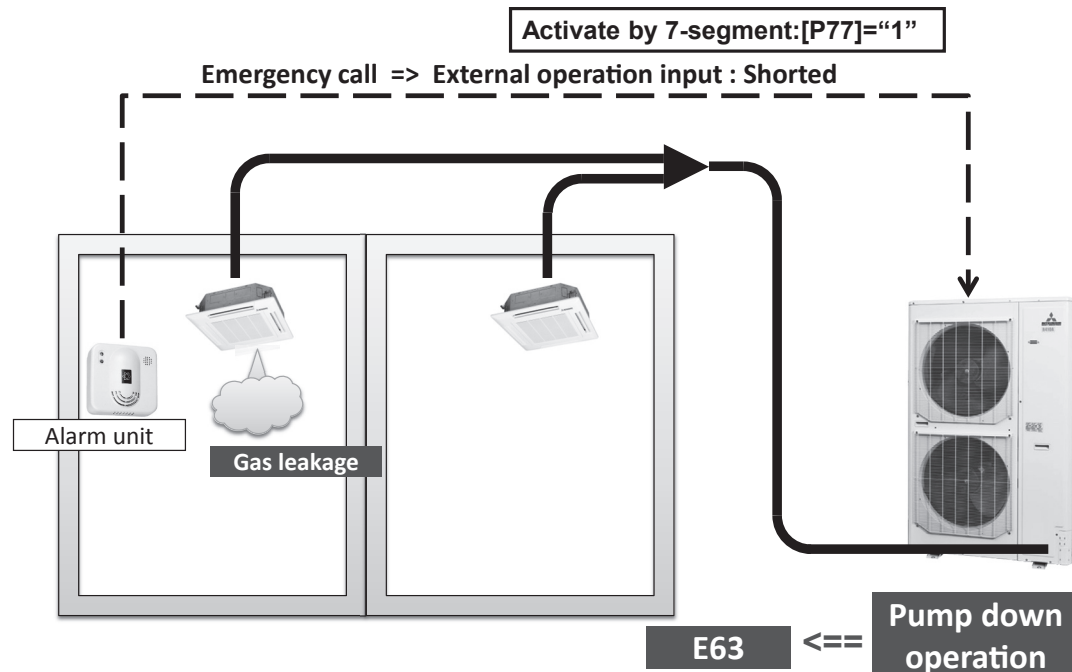

(11) VTCC : Variable Temperature and capacity control (VRF inverter Multi-system energy save control)

On the multi-system, target pressures are set uniformly so that indoor units operate with a constant capacity and repeat the ON/OFF control with which thermostats are turned OFF when temperatures become near the setting temperature.

Owing to the tuning of target high/low pressure near the setting temperature, it becomes possible to perform the high efficiency operation near the setting temperature.

For this reason, duration of time for highly efficient operation is increased by providing the compressor upper limit speed according to the thermostat ON capacity.

• Thermostat ON capacity ... Total capacity of indoor units which are operating with the thermostat ON

(a) Correction of target high/low pressure

(i) Starting condition (either of ① or ②)

① When the external input function assignment [P07] - [P10]: Multi-system energy save control = Valid

② When 7-segment [P39] (Multi-system energy save control I) = ON, if the external input function assignment [P07] - [P10] is not assigned this control.

(ii) Contents of control

① During the outdoor unit operation mode at cooling

• Indoor load more than 50% → Corrected to the target cooling low pressure lower.

• Indoor load less than 50% → Corrected to the target cooling low pressure higher.

② During the outdoor unit operation mode at heating

• Indoor load more than 50% → Corrected to the target heating high pressure higher.

• Indoor load less than 50% → Corrected to the target heating high pressure lower.

(Note) Indoor load condition (%) = $\frac{\text{Total capacity of indoor units of which load is high}}{\text{Total capacity of indoor units with the thermostat ON}}$

(iii) Ending condition

① When the starting conditions are lost.

(b) Compressor upper limit speed restriction for each operation capacity

(i) Starting condition (either of ① or ②)

- ① When the external input assignment [P07] – [P10]: Multi-system energy save operation = Valid and 7-segment [P67] (Multi-system energy save control II) = 1 or 2 or 3
 Factory default: 0 (OFF)/1 (Setting 1), 2 (Setting 2), 3 (Setting 3)
- ② 7-segment [P67] = 1 or 2 or 3, if the external input function assignment [P07] – [P10] is not assigned this control.

(ii) Contents of control

- ① Compressor upper limit speed is the value obtained by multiplying with the upper limit speed restriction rate according to the thermostat ON capacity.
- ② The upper limit restriction rate is divided to the following 3 steps according to each setting of [P67] as follows.

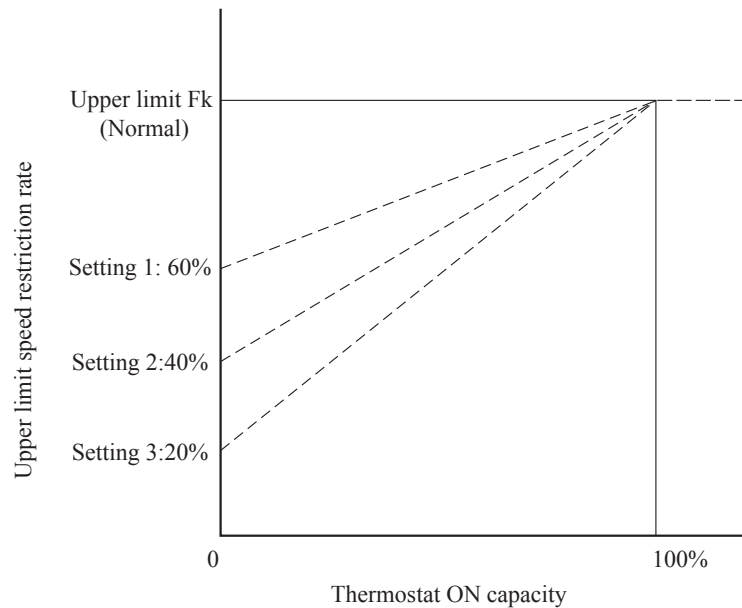

③ Following controls supersede this control.

- 4-way valve safeguard
- Oil return operation
- Pump-down operation for replacement
- Defrost operation
- Oil equalized operation
- Start/Stop pump-down operation

(iii) Ending condition

- ① When the starting conditions are lost.

(C) Data output**(1) 7-segment and operation data retention****(a) 7-segment display**

Operation information is displayed for checking various operation data during test run and for helping malfunction diagnosis at servicing. Input data to microcomputer, contents of outdoor unit control, indoor unit registration information, or other, are mainly displayed on the 7-segment LED.

(i) Operation information display

① Displays each item at 7-segment of 3-digit × 2 on the outdoor unit PCB.

② Display is controlled with the following buttons.

SW9: Setting button for order of 10 of display code

SW8: Setting button for order of 1 of display code

SW7: Data erase/write button

③ Select the order of 10 for the code No. of each item with SW9 or SW8 for the order of 1.

Following identification alphabets are used at the code display .

“C”: “C00” – “C99”

“P”: “P00” – “PXX” (up to a place where content is specified)

④ Code [C96] is operable item. It is possible to delete the retained operation data (data of 30 minutes preceding an anomalous stop) by following resetting procedure.

<Resetting operation>

- Select code [C96]. If any anomalous data is retained, the data display [dEL] is shown.

- Pressing SW7 for 3 seconds erases the memory data on RAM.

(EEPROM data are not erased.)

- As the data are erased, the data display shows [- - -].

When no anomalous data are retained, it displays [---] as well.

- Unless the reset operation is performed, data are retained. Therefore, if normal operation is resumed without the reset operation and an anomalous stop occurs again, no new anomalous data cannot be retained, but former anomalous data are still retained unchanged.

⑤ If you press SW8 (order of 1), the number changes 0 → 1 → 2 ... 9 → 0.

⑥ If you press SW9 (order of 10), the number jumps to the leading code of each order of 10.

Data display [CXX] and setting value display [PXX] are considered to be continuous.

Example: Pressing SW9 at [C07] it changes to [C10]

: Pressing SW9 at [C90], it changes to [P00]

⑦ Codes [C44] are operable items. With the following reset operation, the cumulative compressor operation time corresponding to the code No. can be erased (reset). (Reset of operation time after replacing the compressor)

<Resetting operation>

- Select codes [C44]. Cumulative compressor operation time up to present is displayed.

- Pressing SW7 for 3 seconds erases the memory data.

However, the cumulative compressor operation time data in the 30 minutes log data preceding an anomalous stop (if this retained log data are not deleted) are not erased by this procedure.

⑧ Data display for spare items is left in blank.

(ii) When the temperature is below -10.0°C for the display of discharge pressure saturated temperature and suction pressure saturated temperature, the fraction after decimal point is rounded up. (Because the range of 7-segment display is 3-digit.)

(iii) Return the error No. display after an error to the normal display by turning ON the DIP switch SW3-1.

(iv) Precedence of display

- ① [EXX] > [Related to check operation ([CHJ] > [CHU])] > [PdE] > [PdS] > [oPX] > [CXX]
- ② If resetting from the display of ①, it is switched to [C00].
- ③ If SW8 or SW9 is pressed during the display of ①, it changes to [C00].

However, unless no button input is done for 10 seconds after change to [C00], it changes to the display of ① automatically according to the precedence.

④ Display switching

Special display is the display other than [CXX].

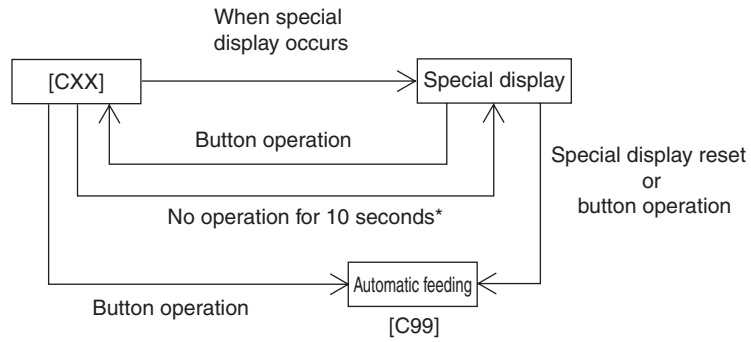

* If the special display is reset in the meanwhile, it remains as [CXX].

(b) List of 7-segment displays

Code No.	Contents of display	Data display range	Minimum unit	Remarks
Error display	[EXX]			
Caution display	[oPX]			
Special display	[PdS][PdE]			
Code No.	Contents of data display	Data display range	Minimum unit	Remarks
<Sensor value, actuator information>				
C00	CM1 operation frequency	0 - 130	1Hz	
C01	(Spare)			
C02	Tho-A Outdoor air temperature	L,-20 - 43	1°C	
C03	Tho-R1 Heat exchanger temperature 1	L,-25 - 73	1°C	
C04	Tho-R2 Heat exchanger temperature 2	L,-25 - 73	1°C	
C05	(Spare)			
C06	(Spare)			
C07	Tho-D1 Discharge pipe temperature (CM1)	L,31 - 136	1°C	
C08	(Spare)			
C09	(Spare)			
C10	Tho-C1 Under-dome temperature (CM1)	L,5 - 90	1°C	
C11	(Spare)			
C12	Tho-P1 Power transistor temperature (CM1)	L,5 - 136	1°C	
C13	(Spare)			
C14	Tho-SC Sub-cooling coil temperature 1	L,18 - 73	1°C	
C15	Tho-H Sub-cooling coil temperature 2	L,-25 - 73	1°C	
C16	Tho-S Suction pipe temperature	L,-25 - 73	1°C	
C17	Inverter secondary current	0 - 50	1A	
C18	CT1 (CM1) current	0 - 50	1A	
C19	(Spare)			
C20	EEVH1 Heating expansion valve opening angle	0 - 500	1 pulse	
C21	(Spare)			
C22	EEVSC Sub-cooling coil expansion valve opening angle	0 - 500	1 pulse	
C23	FMo1 Actual fan speed	0 - 999	10min-1	
C24	FMo2 Actual fan speed	0 - 999	10min-1	
C25	PSH High pressure sensor	0 - 4.15	0.01MPa	
C26	PSL Low pressure sensor	0 - 1.70	0.01MPa	
C27	(Spare)			
C28	(Spare)			
C29	(Spare)			
C30	Pressure switch	0,1 (0: Close, 1: Open)	-	Order of 100: 63H1-1
				Order of 10: (Spare)
				Order of 1: (Spare)
C31	External input	0,1 (0: Close, 1: Open)	-	Order of 100: CnS1
				Order of 10: CnS2
				Order of 1: CnG1

Code No.	Contents of data display	Data display range	Minimum unit	Remarks
C32	External input	0,1 (0: Close, 1: Open)	-	Order of 100: CnG2
				Order of 10: (Spare)
				Order of 1: (Spare)
C33	Relay output	0,1 (0: Close, 1: Open)	-	Order of 100: 52C-1
				Order of 10: 20S
				Order of 1: Crankcase heater 1
C34	Relay output	0,1 (0: Close, 1: Open)	-	Order of 100: SV6
				Order of 10: (Spare)
				Order of 1: (Spare)
C35	Relay output	0,1 (0: Close, 1: Open)	-	Order of 100: SV1
				Order of 10: SV11
				Order of 1: SV12
C36	Relay output	0,1 (0: Close, 1: Open)	-	Order of 100: (Spare)
				Order of 10: (Spare)
				Order of 1: (Spare)
C37	External output	0,1 (0: Close, 1: Open)	-	Order of 100: External output (CnZ1)
				Order of 10: CnH Operation output
				Order of 1: CnY Anomalous output
C38	(Spare)	-	-	
C39	(Spare)	-	-	
<Outdoor unit information>				
C40	Number of connected indoor units	0 - 50	1	
C41	Capacity of connected indoor units	0 - 200	1	
C42	Number of indoor units with thermostat ON	0 - 50	1	
C43	Required Hz total	0 - 999	1Hz	
C44	Cumulative compressor operation time (CM1)	0 - 655	100h	
C45	(Spare)			
C46	Discharge pressure saturated temperature	-50 - 70	0.1°C	Range unable to display (-10°C or under) is in the unit of 1°C.
C47	Suction pressure saturated temperature	-50 - 30	0.1°C	Range unable to display (-10°C or under) is in the unit of 1°C.
C48	Sub-cooling coil temperature sensor 1 saturated pressure	-0.68 - 4.15	0.01 MPa	0 is omitted in negative range. -0.68 → [-.68]
C49	Cooling sub-cooling	0 - 50	0.1deg	
C50	Heating overheat	0 - 50	0.1deg	
C51	Sub-cooling coil overheat	0 - 50	0.1deg	
C52	Discharge pipe overheat 1	0 - 50	0.1deg	
C53	Under-dome overheat 1	0 - 50	0.1deg	
C54	Target cooling low pressure	0.00 - 2.00	0.01MPa	
C55	Target heating high pressure	1.60 - 4.15	0.01MPa	
C56	Target Fk	0 - 999	1Hz	
C57	Inverter 1 operation frequency command	0 - 130	1Hz	
C58	Demand ratio	0 - 100	1%	
C59	FMo1 Fan Speed command	0 - 999	10min-1	
C60	FMo2 Fan Speed command	0 - 999	10min-1	

Code No.	Contents of data display	Data display range	Minimum unit	Remarks
<Anomalous counter information>				
C70	Counter · Sensor wire disconnected	0 - 3	1	
C71	Counter · High pressure protection	0 - 5	1	
C72	Counter · Anomalous low pressure ③ (During operation)	0 - 5	1	
C73	Counter · Anomalous low pressure ① (During stop)	0 - 5	1	
C74	Counter · Discharge pipe 1 anomalous temperature	0 - 5	1	
C75	Counter · Anomalous FMo1 stop	0 - 5	1	
C76	Counter · Anomalous FMo2 stop	0 - 5	1	
C77	Counter · Current cut (CM1)	0 - 4	1	
C78	Counter · Compressor 1 starting failure	0 - 20	1	
C79	Counter · Inverter 1 communication error	0 - 4	1	
C80	Counter · Power transistor 1 overheat	0 - 4	1	
C81	(Spare)			
C82	Counter · Inverter 1 desynchronism error	0 - 127	1	
C83	Counter · Inverter 1 communication error cumulative	0 - 127	1	
C84	Counter · Indoor/outdoor communication error	0 - 255	1	
C85	Counter · CPU reset	0 - 255	1	
C86	(Spare)			
C87	(Spare)			
C88	(Spare)			
C89	(Spare)			
C90	(Spare)			
C91	(Spare)			
C92	(Spare)			
C93	Counter - Liquid-back error	0 - 3	1	
C94	(Spare)			
<Others>				
C95	(Spare)			
C96	Data reset			
C97	Program · Sub version	0 - 991	-	
C98	Program · POL version	0.00 - 9.99	0.01	
C99	Auto feed display	-		

Code No.	Contents of data display	Data display range	Minimum unit	Remarks
<User setting>				
P00	(Spare)	----	—	
P01	Operation preference switching	<u>0 : (Factory default)</u> 0,1,2,3	—	0: First push preference (Factory default) 1: Last push preference 2: Priority of master unit's setting operation mode 3: Priority of required major operation mode
P02	Outdoor fan snow protection control	<u>0 : (Factory default)</u> 0,1-4	—	0: Outdoor fan snow protection control invalid (Factory default) 1-4: Outdoor fan snow protection control valid
P03	Outdoor fan snow protection control ON time setting	<u>30 : (Factory default)</u> 10, 30 - 600 [Sec]	30	Changes like 10, 30, 60 90 ... 600
P04	Demand ratio change value	<u>OFF : (Factory default)</u> OFF,000,040, 060,080		0: OFF, 1: 0%, 2: 40%. 3: 60%, 4: 80% Factory default is 0: OFF.
P05	Silent setting	<u>0 : (Factory default)</u> 0 - 9	1	
P06	External output function allocation	<u>0 : (Factory default)</u> 0 - 9	1	
P07	External input (CnS1) function allocation	<u>0 : (Factory default)</u> 0 - 20	1	
P08	(Spare) External input (CnS2) function allocation	<u>1 : (Factory default)</u> 0 - 20	1	
P09	(Spare) External input (CnG1) function allocation	<u>2 : (Factory default)</u> 0 - 20	1	
P10	(Spare) External input (CnG2) function allocation	<u>3 : (Factory default)</u> 0 - 20	1	

Code No.	Data display contents	Data display range	Min. unit	Remarks
<Service engineer setting>				
P16	(Spare)	-----	----	
P17	(Spare)	-----	----	
P18	(Spare)	-----	----	
P19	Preferencial switch to ensure certain indoor outlet air temperature at heating	0 : (Factory default) 0,1	—	0: Control for ensuring certain indoor outlet air temperature at heating is valid 1: Control for ensuring certain indoor outlet air temperature at heating is invalid
P20	Allowable total capacity of thermostat ON indoor units to ensure certain indoor outlet temperature at heating	110 : (Factory default) 100, 090, 080	10	Changes to 110, 100, 090, 080, 110 ...
P21	Allowable number of thermostat ON indoor units to ensure certain indoor outlet temperature at heating	0 : (Factory default) 0 - 9	1	
P22	(Spare)	-----	----	
P23	(Spare)	-----	----	
P24	(Spare)	-----	----	
P25	(Spare)	-----	----	
<New Superlink setting>				
P30	Superlink communication status	0,1	—	0: Previous Superlink 1: New Superlink
P31	Automatic address setting start input	0 : (Factory default) 0,1	—	0: Automatic address setting standby 1: Automatic address setting start
P32	Input the starting indoor address for automatic address setting	1 : (Factory default) 1 - 127	1	Specify the starting indoor address connected in one refrigerant system for automatic address setting.
P33	Input the number of connected indoor units	1 : (Factory default) 1 - 24 (*)	1	Specify the number of indoor units connected in one refrigerant system for automatic address setting. (*) Maximum connectable number of indoor units for each outdoor unit
P34	Polarity difinition	0 : (Factory default) 0,1	—	0: Network polarity not defined 1: Network polarity defined
P36	(Spare)	—		
P37	(Spare)	—		
P38	(Spare)			
P39	Multi-system energy save control I			

(c) Saving of operation data

Mainly for investigating the causes of market claims, operation data are always saved in memory. If any trouble occurs, the data writing is stopped and only the operation data prior to the time when the trouble occurs are recorded. These data can be loaded to a PC via RS-232C connector of PCB and utilized for identifying causes.

- (i) Operation data for a period of 30minutes prior to the present operation are saved and updated continuously.
- (ii) If an anomalous stop occurs, the data are not updated any more.
- (iii) Data are written in based on 1 minute sampling interval and following data are transmitted to PC upon demand.

Data	Data range	Example
Software version	Ascii 15 bytes	KD3C218##### (# : NULL)
PID (Program ID)	Ascii 2 bytes	5D
Outdoor unit capacity	Ascii 3 bytes	As listed blow
Power source frequency	Ascii 2 bytes	60
Outdoor address	Ascii 2 bytes	00 - 3F
Indoor address × 16 units	Ascii 2 bytes × 16 units	40 - 7F
Indoor capacity × 16 units	Ascii 3 bytes × 16 units	015 - 280

Outdoor unit composition	Outdoor unit capacity data	Remarks
Single type	Example: 10HP - [S10]	S: Display with Horse Power of single type

(iv) Error retention and monitoring data

Code No.	Write contents	Record data				
		Data write range	Unit of write	Number of bytes	Contents	
00	Indoor 1 Thi-A	-14 - 50	A/D value	1	Return air	
01	Indoor 1 Thi-R1	0 - 72	A/D value	1	Heat exchanger 1	
02	Indoor 1 Thi-R2	0 - 72	A/D value	1	Heat exchanger 2	
03	Indoor 1 Thi-R3	0 - 72	A/D value	1	Heat exchanger 3	
04	Indoor 1 EEV	0 - 470	1 pulse	2		
05	Indoor 1 operation/stop	0,1	-	1	0	Stop
					1	Operation
06	Indoor 1 operation mode	0 - 4	-	1	0	Auto
					1	Dry
					2	Cooling
					3	Fan
					4	Heating
07	Indoor 1 request Hz	0 - 255	1Hz	1		
08	Indoor 1 answer Hz	0 - 255	1Hz	1		
09	Indoor 1 indoor local	-	-	1	Bit0	Anti-frost
					Bit1	EEV opening angle implementation
10	Indoor 1 Thi spare	-14 - 50	A/D value	1	Discharge	
11	Indoor 1 type	0 - 67	-	1	0	FDT
					1	FDK
					2	Others
					3	FDE
					4	FDTC
					5	
					6	
					7	
60 -						
12	Indoor 1PID	-	-	1		

Code No.	Write contents	Record data Data write range	Unit of write	Number of bytes	Contents	
0	Error code	00 - 99	-	1	00: No error on outdoor unit 01-99: All errors	
1	Error existing unit address	00 - FF	-	1	00 - 3F: Outdoor 40 - 6F: Indoor	
<Sensor value>						
2	Tho-A Outdoor air temperature	-20 - 70	A/D value	1		
3	Tho-R1 Heat exchanger temperature 1	-40 - 75	A/D value	2		
4	Tho-R2 Heat exchanger temperature 2	-40 - 75	A/D value	2		
5	Tho-D1 Discharge pipe temperature (CM1)	-20 - 140	A/D value	1		
6	Tho-S Suction pipe temperature	-40 - 75	A/D value	2		
7	Tho-SC Sub-cooling coil temperature 1	-40 - 75	A/D value	2		
8	Tho-H Sub-cooling coil temperature 2	-40 - 75	A/D value	2		
9	Tho-P1 Power transistor temperature (Radiator fin)	-20 - 140	A/D value	1		
10	Inverter secondary current	0 - 50	A/D value	1		
11	Tho-C1 Under-dome temperature (CM1)	-40 - 90	A/D value	1		
12	CT1 Current	0 - 50	A/D value	1		
13	High pressure sensor	0 - 4.15	A/D value	1		
14	Low pressure sensor	0 - 1.70	A/D value	1		
<Outdoor unit information>						
15	Number of connected indoor units	0 - 127	1 unit	1		
16	Capacity of connected indoor units	0 - 65535	-	2		
17	Number of indoor units with thermostat ON	0 - 255	1 unit	1		
18	Total capacity of indoor units with cooling thermostat ON	0 - 65535		2		
19	Total capacity of indoor units with heating thermostat ON	0 - 65535		2		
20	Operation mode	0 - 2	-	1	0	Stop
					1	Cooling
					2	Heating
21	Inverter CM1 actual operation frequency	0 - 255	1Hz	1		
22	FMo1 Actual fan speed	0 - 65535	10min ⁻¹	2		
23	FMo2 Actual fan speed	0 - 65535	10min ⁻¹	2		
24	Required Hz total	0 - 65535	1Hz	2		
25	Discharge pressure saturated temperature	-50 - 70	0.01°C	2		
26	Suction pressure saturated temperature	-50 - 30	0.01°C	2		
27	Sub-cooling coil temperature sensor 1 saturated pressure	-0.68 - 4.15	0.01MPa	2		
28	Pressure ratio	1.0 - 10.0	0.1	1		
29	Cooling sub-cooling	0 - 50	0.1deg	2		
30	Suction overheat	0 - 50	0.1deg	2		
31	Sub-cooling coil overheat	0 - 50	0.1deg	2		
32	Discharge pipe overheat	0 - 50	0.1deg	2		
33	Compressor 1 under-dome overheat	0 - 50	0.1deg	2		
34	Target Fk	0 - 65535	1Hz	2		
35	Answer Hz total	0 - 65535	1Hz	2		
36	Inverter 1 operation frequency command	0 - 120	1Hz	1		

Code No.	Write contents	Record data Data write range	Unit of write	Number of bytes	Contents		
37	FMo1 Fan speed command	0 – 65535	10min ⁻¹	2			
38	FMo2 Fan speed command	0 – 65535	10min ⁻¹	2			
39	EEVH1 opening degree	0 – 65535	1 pulse	2			
40	EEVSC opening degree	0 – 65535	1 pulse	2			
41	Compressor target cooling low pressure	0.00 – 2.00	0.01MPa	1			
42	Compressor target heating high pressure	0.00 – 4.15	0.01MPa	2			
43	Outdoor EEVH target superheat	0 – 25.5	0.1°C	1	Actual range: 5°C – 11°C		
44	Outdoor EEVH initial learning opening position	0 – 255	1 pulse	1			
45	Outdoor EEVSC target superheat	0 – 25.5	0.1°C	1			
46	Cumulative amount of hold-up oil	0 – 2550	10cc	1	Actual range: 0cc – 1100cc		
47	Oil return count down	0 – 255	3 min.	1	Actual range: 0 – 600min (10 hour)		
<PCB hardware input>							
48	External input	–	–	1	Bit0	63H1	0: Open, 1: Short-circuit
					Bit1	(Spare)	0: Open, 1: Short-circuit
					Bit2	CnS1	0: Open, 1: Short-circuit
					Bit3	CnS2	0: Open, 1: Short-circuit
					Bit4	CnG1	0: Open, 1: Short-circuit
					Bit5	CnG2	0: Open, 1: Short-circuit
					Bit6	(Spare)	0: Open, 1: Short-circuit
					Bit7	(Spare)	0: Open, 1: Short-circuit
49	DIP switch [SW3]	–	–	1	Bit0	SW3-1	0: OFF, 1: ON
					Bit1	SW3-2	0: OFF, 1: ON
					Bit2	SW3-3	0: OFF, 1: ON
					Bit3	SW3-4	0: OFF, 1: ON
					Bit4	SW3-5	0: OFF, 1: ON
					Bit5	SW3-6	0: OFF, 1: ON
					Bit6	SW3-7	0: OFF, 1: ON
					Bit7	SW3-8	0: OFF, 1: ON
50	DIP switch [SW4]	–	–	1	Bit0	SW4-1	0: OFF, 1: ON
					Bit1	SW4-2	0: OFF, 1: ON
					Bit2	SW4-3	0: OFF, 1: ON
					Bit3	SW4-4	0: OFF, 1: ON
					Bit4	SW4-5	0: OFF, 1: ON
					Bit5	SW4-6	0: OFF, 1: ON
					Bit6	SW4-7	0: OFF, 1: ON
					Bit7	SW4-8	0: OFF, 1: ON
51	DIP switch [SW5]	–	–	1	Bit0	SW5-1	0: OFF, 1: ON
					Bit1	SW5-2	0: OFF, 1: ON
					Bit2	SW5-3	0: OFF, 1: ON
					Bit3	SW5-4	0: OFF, 1: ON
					Bit4	SW5-5	0: OFF, 1: ON
					Bit5	SW5-6	0: OFF, 1: ON
					Bit6	SW5-7	0: OFF, 1: ON
					Bit7	SW5-8	0: OFF, 1: ON

Code No.	Write contents	Record data Data write range	Unit of write	Number of bytes	Contents		
52	DIP switch [SW6]	-	-	1	Bit0	SW6-1	0 : OFF, 1 : ON
					Bit1	SW6-2	0 : OFF, 1 : ON
					Bit2	SW6-3	0 : OFF, 1 : ON
					Bit3	SW6-4	0 : OFF, 1 : ON
					Bit4	SW6-5	0 : OFF, 1 : ON
					Bit5	SW6-6	0 : OFF, 1 : ON
					Bit6	SW6-7	0 : OFF, 1 : ON
					Bit7	SW6-8	0 : OFF, 1 : ON
53	Jumper wire	-	-	1	Bit0	J11	0: Open, 1: Short-circuit
					Bit1	J12	0: Open, 1: Short-circuit
					Bit2	J13	0: Open, 1: Short-circuit
					Bit3	J14	0: Open, 1: Short-circuit
					Bit4	J15	0: Open, 1: Short-circuit
					Bit5	J16	0: Open, 1: Short-circuit
					Bit6	(Spare)	
					Bit7	(Spare)	
<PCB hardware output>							
54	Relay output	-	-	1	Bit0	52X1, 52X2	0 : OFF, 1 : ON
					Bit1	20S	0 : OFF, 1 : ON
					Bit2	CH1	0 : OFF, 1 : ON
					Bit3	SV1	0 : OFF, 1 : ON
					Bit4	SV6	0 : OFF, 1 : ON
					Bit5	SV11	0 : OFF, 1 : ON
					Bit6	(Spare)	0 : OFF, 1 : ON
					Bit7	(Spare) FMC1,2	0 : OFF, 1 : ON
55	Relay output	-	-	1	Bit0	Operation output (CnH)	0 : OFF, 1 : ON
					Bit1	Error output (CnY)	0 : OFF, 1 : ON
					Bit2	External output (CnZ)	0 : OFF, 1 : ON
					Bit3	(Spare)	0 : OFF, 1 : ON
					Bit4	(Spare)	0 : OFF, 1 : ON
					Bit5	(Spare)	0 : OFF, 1 : ON
					Bit6	(Spare)	0 : OFF, 1 : ON
					Bit7	(Spare)	0 : OFF, 1 : ON
<Related to compressor>							
56	CM1 Cumulative operation hours (Approx.)	0 - 65535	1h	2			
57	CM1 Starting times	0 - 65535	× 20 times	2			
58	CM1 3-minute delay timer	0 - 180	1 sec	1			
59	Energizing time count down	0 - 255	1 min	1			
60	Control status CH Compressor protection timer	0 - 360	3 min	1			
61	Control status CH Compressor protection start	0 - 15	-	1	15	Protection start complete	
					0 - 14	Protection start ON	

Code No.	Write contents	Record data Data write range	Unit of write	Number of bytes	Contents	
<Error counter information>						
72	Control status HP (63H1) anomaly counter	0 - 5	1	1		
73	Control status LP anomaly counter while running	0 - 5	1	1		
74	Control status LP anomaly counter while stopping	0 - 5	1	1		
75	Control status Td1 error counter	0 - 5	1	1		
76	Control status DC fan motor 1 error counter	0 - 5	1	1		
77	Control status DC fan motor 2 error counter	0 - 5	1	1		
78	Control status sensor wire disconnected counter	0 - 3	1	1		
79	Control status INV1 current cut error counter	0 - 4	1	1		
80	Control status INV1 starting failure counter	0 - 20	1	1		
81	Control status INV1 communication error counter	0 - 4	1	1		
82	Control status INV1 desynchronism error counter	0 - 4	1	1		
83	Control status INV1 communication error counter cumulative	0 - 255	1	1		
84	(Spare) Control status INV1 power transistor overheat error counter	0 - 4	1	1		
85	Control status INV1 rotor lock error counter	0 - 127	1	1		
<Setting value display>						
86	Operation priority switching	0 - 3	-	1	0	First push priority
					1	Last push priority
					2	Director mode
					3	Operation mode capacity priority
87	Outdoor fan snow protection control	0,1		1	0	Valid
					1	Invalid
88	Outdoor fan snow protection control ON time setting	30: (Factory default) 10, 30 - 600 [sec]	10 sec	1		
89	Demand ratio change value	OFF, 000, 040, 060, 080 Factory default 0: OFF	-	1		
90	Silent mode setting	0 - 9	-	1		
91	CnS1 function allocation value	0 - 20	-	1		
92	CnS2 function allocation value	0 - 20	-	1		
93	CnG1 function allocation value	0 - 20	-	1		
94	CnG2 function allocation value	0 - 20	-	1		
95	External output function allocation	0 - 9	-	1		
96	Target cooling low pressure compensation	-0.20 - +0.20	0.01MPa	1		
97	Target cooling high pressure compensation	0.00 - 0.40	0.01MPa	1		
98	Heating setting 1 (Target outlet temperature)	40 - 50	1 [°C]	1		

Code No.	Write contents	Record data Data write range	Unit of write	Number of bytes	Contents		
99	Heating setting 2 (Target high pressure)	3.15 - 2.75	0.05 [MPa]	1			
100	Heating setting 3 (Judgment temperature)	30 - 38	1 [°C]	1			
<Other>							
104	Override number	0 -	-	1			
<Indoor unit information>							
106	Registered indoor 1 - 8 operation mode	0 - 4	-	8	0	Auto	
					1	Humidifying	
					2	Cooling	
					3	Fan	
					4	Heating	
107	Registered indoor 1 - 8 request Hz	0 - 255	1Hz	8			
108	Registered indoor 1 - 8 answer Hz	0 - 255	1Hz	8			

Compressor stop cause (Cord No. C68)

It shows the latest compressor anomalous stop cause

Compressor stop cause		No
	At power on	0
Sensor disconnection and/or short-circuit	Outdoor air temperature sensor	1
	Outdoor heat exchanger temperature sensor 1	2
	Outdoor heat exchanger temperature sensor 2	3
	Discharge pipe temperature sensor 1(CM1)	4
	Suction pipe temperature sensor	5
	Sub-cooling temperature sensor 1(liquid side)	6
	Sub-cooling temperature sensor 2(gas side)	7
	Under-dome temperature sensor 1	8
	Power transistor temperature sensor 1	9
	Active filter temperature sensor	10
	High pressure sensor	11
	Low pressure sensor	12
Anomaly detection	HP anomaly	20
	LP anomaly	21
	Td1 anomaly	22
	FMo1 anomaly	23
	FMo2 anomaly	24
	Inverter 1 current cut	25
	Inverter 1 startup failure	26
	Inverter 1 communication error	27
	Inverter 1 anomalous compressor induced voltage and torque	28
	Inverter 1 power transistor overheat	29
	Inverter 1 rotor lock	30
Liquid flooding anomaly	31	
Stop by restriction	Outdoor operation mode heating/cooling switching	40
	Heating overload protection	41

(2) Outdoor PCB setting

Code	Input	Remarks
SW1	Outdoor address No. (Order of 10)	
SW2	Outdoor address No. (Order of 1)	
SW3-1	Inspection LED reset	Normal ★/Reset
SW3-2	Automatic backup operation	None ★/With
SW3-7	Forced heating/cooling	Normal ★/Forced heating-cooling
SW3-8	Test mode	Normal ★/Test
SW5-1	Test run switch	Normal ★/Test run
SW5-2	Test run	Heating ★/Cooling
SW5-3	Pump down switch	Normal ★/Pump down
SW7	Data erase/Write	
SW8	7-segment display code No. increasing (order of 1)	
SW9	7-segment display code No. increasing (order of 10)	
SW4-1	Model selection	See following table.
SW4-2		
SW4-3		
SW4-4		
SW4-5	Demand ratio selection	See following table.
SW4-6	Demand ratio selection	See following table.
SW5-5	Superlink selection	New Superlink ★/Previous Superlink
J11	Power source voltage selection	Open
J12	Power source voltage selection	Open
J13	External input Level/Pulse	Level ★/Pulse
J14	Defrost reset temperature	Normal ★/Intensive
J15	Defrost start temperature Normal/Cold region	Normal ★/Cold weather region

Notes (1) Jumper wires J13, J15 indicate short-circuit/open.

(2) Dip switch SW's indicate OFF/ON.

(3) ★ indicates the factory default setting (OFF).

■ **Model selection with SW4-1 – SW4-4**

Model Switch	FDC224	FDC280	FDC335
SW4-1	0	1	0
SW4-2	0	0	1
SW4-3	0	0	0
SW4-4	0	0	1

Note (1) 0: OFF, 1: ON

■ **Demand ratio selection with SW4-5, SW4-6**

SW4-5	SW4-6	Compressor capacity (%)
0	0	80
1	0	60
0	1	40
1	1	0

Note (1) 0: OFF, 1: ON

2. SYSTEM TROUBLESHOOTING PROCEDURE

2.1 Basics of troubleshooting

Basic troubleshooting is to check/analyze/save data by connecting the Mente PC.

Whenever arriving at the site, always connect the Mente PC before starting work.

Method of error data analysis (Basic procedure)

- Identify whether particular error occurred during operation or stopping.
- Is it caused by the installation conditions of outdoor/indoor unit? (Refrigerant quantity, pipe length, short-circuit, clogged filte , etc.)
- Isn't there any beginner's mistake at the installation? (Wrong address, mistake in piping or wiring, etc.)
- Is the failure related to any hardware (parts)? (SV main body, coil, capillary, check valve, sensor, etc.)
- Is it a major component?
- Compressor, inverter PCB and outdoor DC fan motor.
- Is it a failure of electrical component?

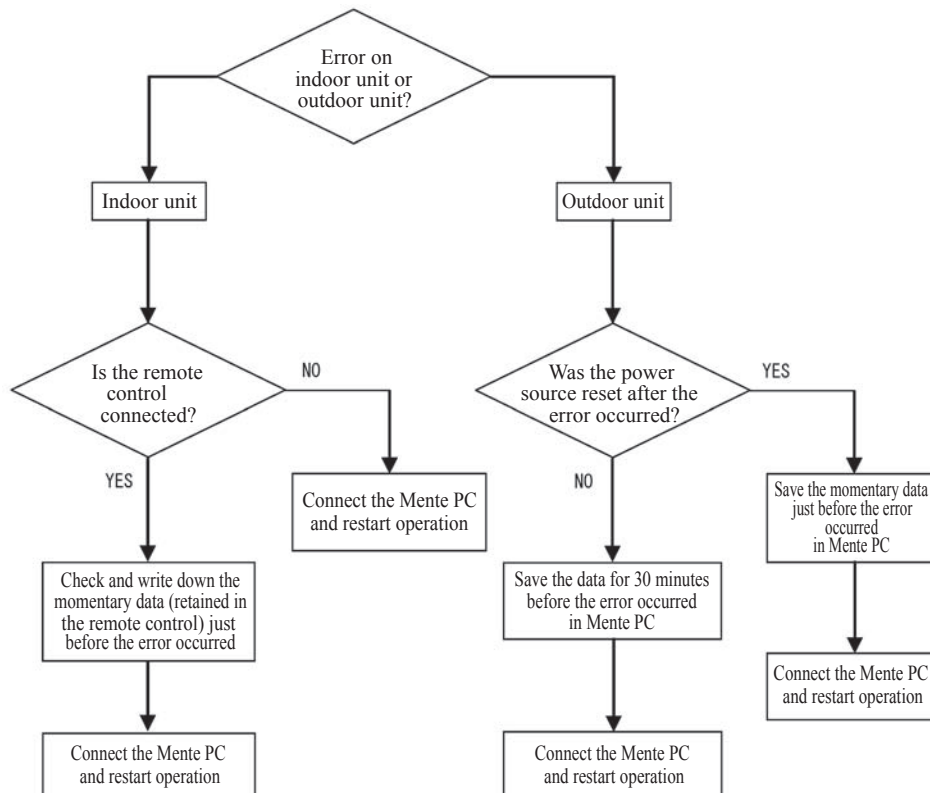

2.2 Explanation of troubleshooting

(a) Checking 15V on the control PCB (Step to check if the inverter PCB fails or not)

Use this to diagnose E41, E42, E45 and E48.

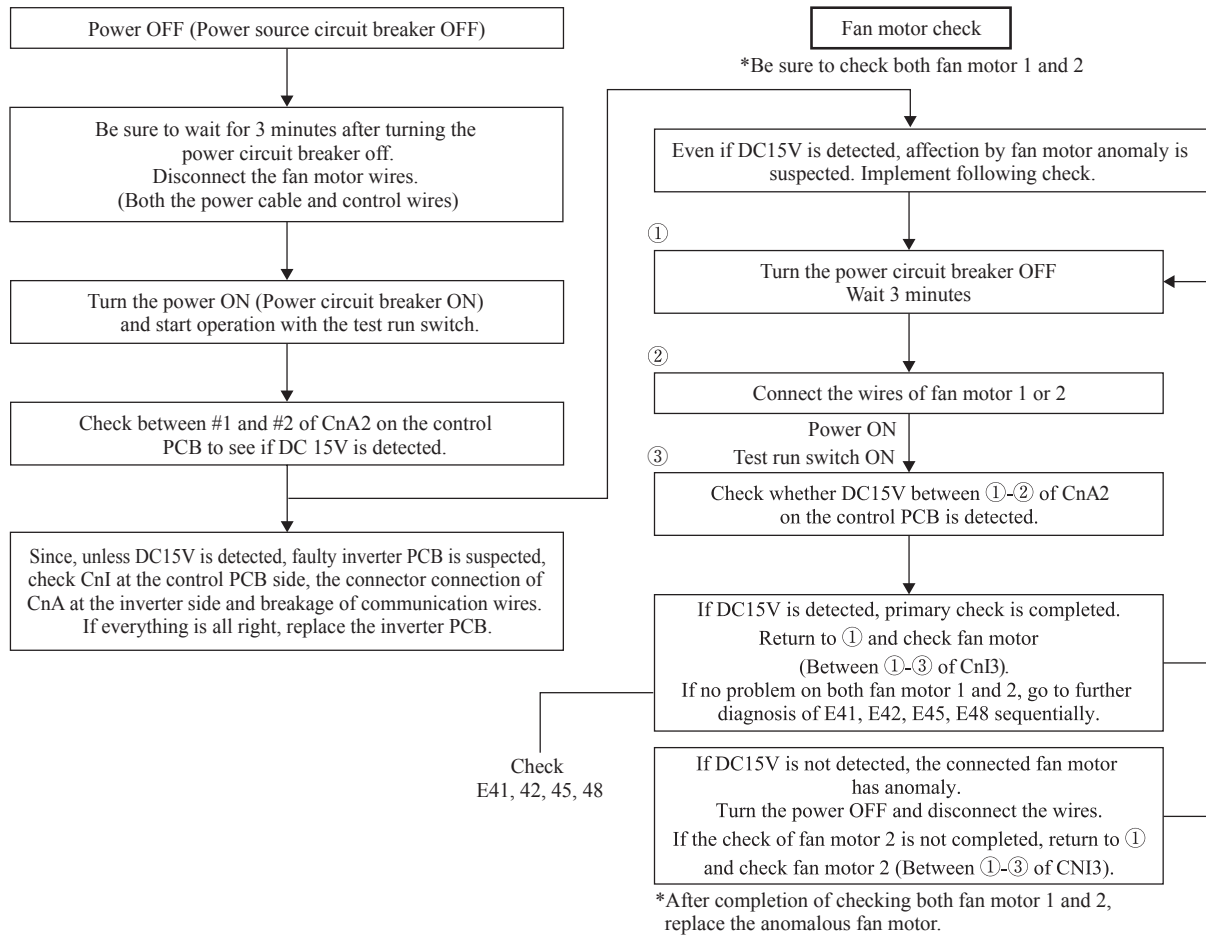

(b) Inspection of short-circuit on the power transistor module terminals

Disconnect the wiring of compressor and check for short-circuit with a tester.

Inspect between terminals of: P-U, P-V, P-W, N-U, N-V, N-W and P-N

It will be easier to contact the tester at the following place at each terminal.

P: P terminal of power transistor

N: N terminal of power transistor

U: End of red harness to compressor

V: End of white harness to compressor

W: End of blue harness to compressor

Terminal (+)	Terminal (-)	Normal value (Ω)
P	N	Several 10 M
N	P	Several M
P	U	Several 10 M
P	V	
P	W	Several 100K
N	U	
N	V	
N	W	Several 100K
U	P	
V	P	Several 10 M
W	P	
U	N	
V	N	Several 10 M
W	N	

Note (1) When a measured value is 0 – a few kΩ, the element may be broken. Replace the power transistor part.

2.3 Contents of troubleshooting

(a) List of inspection displays

1) Indoor and outdoor units

Remote control error code	7-segment display	Name of inspection	Classification	Page
E1	—	Remote control communication error	Communication error	81
E2	—	Duplicated indoor unit address	Address setting error	82
E3	—	Outdoor unit signal line error	Address pairing setting error	83
E5	—	Communication error during operation	Communication error	84
E6	—	Indoor unit heat exchanger temperature sensor anomaly (Thi-R)	Sensor wire breakage	85
E7	—	Indoor return air temperature sensor anomaly (Thi-A)	Sensor wire breakage	86
E9	—	Drain trouble	System error	87
E10	—	Excessive number of indoor units (more than 17 units) by controlling one remote control	Communication error	88
E12	—	Address setting error by mixed setting method	Address setting error	89
E16	—	Indoor fan motor anomaly (FDT series)	DC fan motor error	90
	—	Indoor fan motor anomaly (FDK series)	DC fan motor error	91
E19	—	Indoor unit operation check drain pump motor check mode anomaly	Setting error	92
E28	—	Remote control temperature sensor anomaly (The)	Sensor wire breakage	93
E30	E30	Unmatch connection of indoor and outdoor unit	System error	94
E31	E31	Duplicated outdoor unit address No.	Address setting error	95
E32	E32	Open L3 Phase on power source at primary side	Site setting error	96
E36	E36-1	Discharge pipe temperature error (Tho-D1)	System error	97
	E36-3	Liquid flooding anomaly	System error	98
E37	E37-1, 2 E37-5, 6	Outdoor unit heat exchanger temperature sensor (Tho-R) and subcooling coil temperature sensor (Tho-SC, -H) anomaly	Sensor wire breakage	99
E38	E38	Outdoor air temperature sensor anomaly (Tho-A)	Sensor wire breakage	100
E39	E39-1	Discharge pipe temperature sensor anomaly (Tho-D1)	Sensor wire breakage	101
E40	E40	High pressure anomaly (63H1-1 activated)	System error	102
E41 (E51)	E41 (E51)-1	Power transistor overheat	System error	103
E42	E42-1	Current cut (CM1)	System error	104
E43	E43-1 E43-2	Excessive number of indoor units connected, excessive total capacity of connection	Site setting error	105
E45	E45-1	Communication error between inverter PCB and outdoor unit control (PCB)	Communication error	106
E46	E46	Mixed address setting methods coexistent in same network	Address setting error	107
E48	E48-1 E48-2	Outdoor unit DC fan motor anomaly	DC fan motor error	108
E49	E49	Low pressure anomaly	System error	109
E53/E55	E53/E55-1	Suction pipe temperature sensor anomaly (Tho-S), Under-dome temperature sensor anomaly (Tho-C1)	Sensor wire breakage	110
E54	E54-1 E54-2	High pressure sensor anomaly (PSH)/Low pressure sensor anomaly (PSL)	Sensor wire breakage	111
E56	E56-1	Power transistor temperature sensor anomaly (Tho-P1)	Sensor wire breakage	112
E58	E58-1	Anomalous compressor by loss of synchronism	System error	113
E59	E59-1	Compressor startup failure (CM1)	System error	114
E60	E60-1	Rotor position detection failure (CM1)	System error	115
E63	E63	Emergency stop	Site setting error	116

2) Option control in-use

SL1N-E SL2NA-E SL4-AE/BE		Indoor unit control PCB		Outdoor unit control PCB		Location of trouble	Description of trouble	Repair method
Error code	Red LED	Red LED	Green LED	Red LED	Green LED			
E75	Keeps flashing	Stays OFF	Keeps flashing	Stays OFF	Keep flashing	SL1N-E SL2NA-E SL4-AE/BE	• Communication error (Defective communication circuit on the main unit of SL1N-E, SL2NA-E or SL4-AE/BE)	Replacement

(b) Troubleshooting

Error code Remote control: None 7-segment display:	LED	Green	Red	Content Operates but does not cool
	Indoor	Keeps flashing	Stays Off	
	Outdoor	Keeps flashing	Stays Off	

1. Applicable model
All models
2. Error detection method
3. Condition of error displayed
4. Presumable cause
<ul style="list-style-type: none"> Poor compression of compressor Expansion valve anomaly

5. Troubleshooting				
<table border="1"> <thead> <tr> <th>Diagnosis</th> <th>Countermeasure</th> </tr> </thead> <tbody> <tr> <td> <p>Check the indoor fan operation Check the temperature difference between return and suction air of indoor unit</p> <p>Is the temperature difference between return and suction air 10-20°C at cooling?</p> <p>NO → Is the compressor operating?</p> <p>NO → Mistake in model selection. Calculate heat load once more.</p> <p>NO → "WAIT" message is displayed [for 3 seconds] when performing cooling, defumidifying or heating operation from remote control?</p> <p>NO → Is the compressor rotation speed low?</p> <p>NO →</p> <p>YES → Check following operation control function. · Control for determining compressor rotation speed · Protective control by controlling compressor rotation speed Which control is appropriate to this phenomenon</p> <p>Is the operating conditions of indoor/outdoor unit under rated condition?</p> <p>NO → The unit is operating normally, but is operating under the protective control of compressor or other respective components</p> <p>Note (1) Outdoor: 35°C Indoor : 27°CDB/19°CWB</p> </td> <td> <p>It is normal. (This unit is designed to start in the soft start mode by detecting the compressor under-dome temperature when it restart after power reset.)</p> <p>It is necessary to replace to higher capacity unit or to install additional unit.</p> <p>Compressor refrigerant oil protective control at starting is activated. For the contents of control, refer to the compressor start control.</p> <p>Compressor may be stopped by the error detection control. For the contents of control, refer to anomalous stop control by controlling compressor rotation speed of microcomputer control function.</p> <p>Check the followings</p> <ul style="list-style-type: none"> Minor clogging of filter Minor fouling of heat exchanger Minor short-circuit of air flow Slightly insufficient or excessive refrigerant amount Poor compression of compressor <p>Check suspicious points considering appropriate operation control.</p> <p>Check the followings for reference</p> <ul style="list-style-type: none"> Severe clogging of filter Severe clogging of heat exchanger Severe short-circuit of air flow Severely insufficient or excessive refrigerant amount Under protective control of compressor Indoor unit fan tap setting Valid setting of silent mode </td> </tr> </tbody> </table>	Diagnosis	Countermeasure	<p>Check the indoor fan operation Check the temperature difference between return and suction air of indoor unit</p> <p>Is the temperature difference between return and suction air 10-20°C at cooling?</p> <p>NO → Is the compressor operating?</p> <p>NO → Mistake in model selection. Calculate heat load once more.</p> <p>NO → "WAIT" message is displayed [for 3 seconds] when performing cooling, defumidifying or heating operation from remote control?</p> <p>NO → Is the compressor rotation speed low?</p> <p>NO →</p> <p>YES → Check following operation control function. · Control for determining compressor rotation speed · Protective control by controlling compressor rotation speed Which control is appropriate to this phenomenon</p> <p>Is the operating conditions of indoor/outdoor unit under rated condition?</p> <p>NO → The unit is operating normally, but is operating under the protective control of compressor or other respective components</p> <p>Note (1) Outdoor: 35°C Indoor : 27°CDB/19°CWB</p>	<p>It is normal. (This unit is designed to start in the soft start mode by detecting the compressor under-dome temperature when it restart after power reset.)</p> <p>It is necessary to replace to higher capacity unit or to install additional unit.</p> <p>Compressor refrigerant oil protective control at starting is activated. For the contents of control, refer to the compressor start control.</p> <p>Compressor may be stopped by the error detection control. For the contents of control, refer to anomalous stop control by controlling compressor rotation speed of microcomputer control function.</p> <p>Check the followings</p> <ul style="list-style-type: none"> Minor clogging of filter Minor fouling of heat exchanger Minor short-circuit of air flow Slightly insufficient or excessive refrigerant amount Poor compression of compressor <p>Check suspicious points considering appropriate operation control.</p> <p>Check the followings for reference</p> <ul style="list-style-type: none"> Severe clogging of filter Severe clogging of heat exchanger Severe short-circuit of air flow Severely insufficient or excessive refrigerant amount Under protective control of compressor Indoor unit fan tap setting Valid setting of silent mode
Diagnosis	Countermeasure			
<p>Check the indoor fan operation Check the temperature difference between return and suction air of indoor unit</p> <p>Is the temperature difference between return and suction air 10-20°C at cooling?</p> <p>NO → Is the compressor operating?</p> <p>NO → Mistake in model selection. Calculate heat load once more.</p> <p>NO → "WAIT" message is displayed [for 3 seconds] when performing cooling, defumidifying or heating operation from remote control?</p> <p>NO → Is the compressor rotation speed low?</p> <p>NO →</p> <p>YES → Check following operation control function. · Control for determining compressor rotation speed · Protective control by controlling compressor rotation speed Which control is appropriate to this phenomenon</p> <p>Is the operating conditions of indoor/outdoor unit under rated condition?</p> <p>NO → The unit is operating normally, but is operating under the protective control of compressor or other respective components</p> <p>Note (1) Outdoor: 35°C Indoor : 27°CDB/19°CWB</p>	<p>It is normal. (This unit is designed to start in the soft start mode by detecting the compressor under-dome temperature when it restart after power reset.)</p> <p>It is necessary to replace to higher capacity unit or to install additional unit.</p> <p>Compressor refrigerant oil protective control at starting is activated. For the contents of control, refer to the compressor start control.</p> <p>Compressor may be stopped by the error detection control. For the contents of control, refer to anomalous stop control by controlling compressor rotation speed of microcomputer control function.</p> <p>Check the followings</p> <ul style="list-style-type: none"> Minor clogging of filter Minor fouling of heat exchanger Minor short-circuit of air flow Slightly insufficient or excessive refrigerant amount Poor compression of compressor <p>Check suspicious points considering appropriate operation control.</p> <p>Check the followings for reference</p> <ul style="list-style-type: none"> Severe clogging of filter Severe clogging of heat exchanger Severe short-circuit of air flow Severely insufficient or excessive refrigerant amount Under protective control of compressor Indoor unit fan tap setting Valid setting of silent mode 			

Note:

Error code Remote control: None 7-segment display:	LED	Green	Red	Content Operates but does not heat
	Indoor	Keeps flashing	Stays Off	
	Outdoor	Keeps flashing	Stays Off	

1. Applicable model
All models
2. Error detection method
3. Condition of error displayed
4. Presumable cause
<ul style="list-style-type: none"> • 4-way valve anomaly • Poor compression of compressor • Expansion valve anomaly

5. Troubleshooting	
Diagnosis	
<p>Check the indoor fan operation Check the temperature difference between return and suction air of indoor unit</p> <p>Is the temperature difference between return and suction air 10-30°C at heating?</p> <p>NO</p> <p>Is the compressor operating?</p> <p>NO</p> <p>Is the compressor rotation speed low?</p> <p>NO</p> <p>Check following operation control function. · Control for determining compressor rotation speed · Protective control by controlling compressor rotation speed Which control is appropriate to this phenomenon</p> <p>Is the operating conditions of indoor/outdoor unit under rated condition?</p> <p>NO</p> <p>The unit is operating normally, but is operating under the protective control of compressor or other respective components</p> <p>Note (1) Outdoor: 7°C Indoor: 20°C</p>	<p>Countermeasure</p> <p>It is normal. (This unit is designed to start in the soft start mode by detecting the compressor under-dome temperature when it restart after power reset.)</p> <p>It is necessary to replace to higher capacity unit or to install additional unit.</p> <p>Compressor refrigerant oil protective control at starting is activated. For the contents of control, refer to the compressor start control.</p> <p>Compressor may be stopped by the error detection control. For the contents of control, refer to anomalous stop control by controlling compressor rotation speed of microcomputer control function.</p> <p>Check the followings</p> <ul style="list-style-type: none"> • Minor clogging of filter • Minor fouling of heat exchanger • Minor short-circuit of air flow • Slightly insufficient or excessive refrigerant amount • Poor compression of compressor <p>Check suspicious points considering appropriate operation control.</p> <p>Check the followings for reference</p> <ul style="list-style-type: none"> • Severe clogging of filter • Severe clogging of heat exchanger • Severe short-circuit of air flow • Severely insufficient or excessive refrigerant amount • Under protective control of compressor • Indoor unit fan tap setting • Valid setting of silent mode

Note:

Error code Remote control: None 7-segment display:	LED	Green	Red	Content Earth leakage breaker activated
	Indoor	Stays Off	Stays Off	
	Outdoor	Stays Off	Stays Off	

1. Applicable model
All models

2. Error detection method

3. Condition of error displayed

4. Presumable cause
<ul style="list-style-type: none"> • Compressor anomaly • Noise

5. Troubleshooting	
Diagnosis	Countermeasure
<pre> graph TD D1{Are the insulation resistance and coil resistance of compressor OK?} -- NO --> C1[Replace compressor.*] D1 -- YES --> D2{Is insulation of respective harnesses OK?} D2 -- NO --> C2[Secure insulation resistance.] D2 -- YES --> D3{Is any harness bitten between panel and casing or etc.?} D3 -- YES --> C3[Secure insulation resistance.] D3 -- NO --> P1[Check the outdoor unit grounding wire and earth leakage breaker] P1 --> P2[Check of the outdoor unit grounding wire and earth leakage breaker] </pre> <p>Check of the outdoor unit grounding wire and earth leakage breaker</p> <p>① Run an independent grounding wire from the grounding screw of outdoor unit to the grounding terminal on the distribution panel. (Do not connect to another grounding wire.)</p> <p>② In order to prevent malfunction of the earth leakage breaker itself, confirm the conformity of high harmonic regulation.</p> <p>* Insulation resistance of compressor</p> <ul style="list-style-type: none"> • Immediately after installation or when the unit has been left for long period without power source, the insulation resistance may drop to a few $Mk\Omega$ because of refrigerant migrated in the compressor. <p>When the earth leakage breaker is activated at lower insulation resistance, check the following points.</p> <p>① 6 hours after power ON, check if the insulation resistance recovers to normal.</p> <p>When power ON, crankcase heater heat up compressor and evaporates the refrigerant migrated in the compressor.</p> <p>② Check if the earth leakage breaker is conformed to higher harmonic regulation or not.</p> <p>Since the unit has inverter, it is necessary to use components conformed to high harmonic regulation in order to prevent malfunction of earth leakage breaker.</p>	

Note:

Error code Remote control: None 7-segment display:	LED	Green	Red	Content <h2 style="text-align: center;">Excessive noise/vibration (1/3)</h2>
	Indoor	-	-	
	Outdoor	-	-	

<h3>1. Applicable model</h3> <p>All models</p>	<h3>5. Troubleshooting</h3>	
<h3>2. Error detection method</h3>	<h4>Diagnosis</h4>	<h4>Countermeasure</h4> <p>If excessive noise/vibration persists when sufficient time has elapsed after stopping the unit, it is considered that the air-conditioner is not the source.</p> <p>Check the installed condition carefully, and correct the installed position or insert rubber cushions into the gap or take other measure in order to eliminate looseness.</p> <p>Prevent the vibration from transmitting to wall and etc by fixing pipes on the wall tightly or wrapping rubber cushion around the pipe which goes through the hole in the wall or applying other appropriate means.</p> <p>Strength of ceiling wall, floor, etc. may be insufficient. Review the installation place or apply reinforcement to increase the strength.</p> <p>Check for leaning of installed unit or incorrect mounting of fan, louver or motor, and then specify the contacting point and correct it.</p> <p>When the heat exchanger or filter is clogged, clean them.</p> <p>In case that the unit is installed at the site where background noise is very low, even the low level noise from indoor unit like as refrigerant flow noise can be heard, but it is normal. Before installation, check for background noise. If background noise is very low, convince client prior to installation.</p>
<h3>3. Condition of error displayed</h3>		
<h3>4. Presumable cause</h3> <ol style="list-style-type: none"> ① Improper installation work <ul style="list-style-type: none"> • Improper vibration-proof work at installation • Insufficient strength of mounting surface ② Anomaly of product <ul style="list-style-type: none"> • Before/after shipment from factory ③ Improper adjustment during commissioning <ul style="list-style-type: none"> • Excessive/insufficient refrigerant. 		

Note:

Error code Remote control: None 7-segment display:	LED	Green	Red	Content Excessive noise/vibration (2/3)
	Indoor	-	-	
	Outdoor	-	-	

1. Applicable model
All models
2. Error detection method
3. Condition of error displayed
4. Presumable cause

5. Troubleshooting	
Diagnosis	Countermeasure
<pre> graph TD Start([From 1/3]) --> Q1{[Unit] Does noise/vibration occur when the cooling/heating operation is performing normally?} Q1 -- NO --> End([To 3/3]) Q1 -- YES --> Q2{Are the pipes contacting with the casing?} Q2 -- YES --> C1[Rearrange the piping to avoid contact with the casing.] Q2 -- NO --> Q3{Is continuous hissing or roaring sound occurred?} Q3 -- YES --> C2[Noise/vibration is generated when the refrigerant gas or liquid flows through inside of piping of air-conditioner. It is likely to occur particularly during cooling or defrost operation in the heating mode. It is normal.] Q3 -- NO --> Q4{Is hissing sounds occurred at the startup or stopping?} Q4 -- YES --> C3[The noise/vibration occurs when the refrigerant starts or stops flowing. It is normal.] Q4 -- NO --> Q5{Is blowing sound occurred at the start/stop of defrost operation during heating mode?} Q5 -- YES --> C4[When the defrost operation starts or stops during heating mode, the refrigerant flow is reversed due to switching 4-way valve. This causes a large change in pressure which produces a blowing sound. It may also accompany the hissing sound as mentioned above. This is normal.] Q5 -- NO --> Q6{Is cracking noise occurred during heating operation?} Q6 -- YES --> C5[After the start or stop of heating operation or during defrost operation, abrupt changes in temperature cause resin parts to shrink or expand. This is normal.] Q6 -- NO --> Q7{Is hissing noise occurred during cooling operation or after operation stopped?} Q7 -- YES --> C6[It is the sound produced by the drain pump that discharges drain from indoor unit. The pump continues to run for 5 minutes after stopping the cooling operation. This is normal.] Q7 -- NO --> C7[Apply the damper sealant at the place considered to be the sources such as the pressure reducing mechanism. (Expansion valve, capillary tube, etc.)] </pre>	<p>Rearrange the piping to avoid contact with the casing.</p> <p>Noise/vibration is generated when the refrigerant gas or liquid flows through inside of piping of air-conditioner. It is likely to occur particularly during cooling or defrost operation in the heating mode. It is normal.</p> <p>The noise/vibration occurs when the refrigerant starts or stops flowing. It is normal.</p> <p>When the defrost operation starts or stops during heating mode, the refrigerant flow is reversed due to switching 4-way valve. This causes a large change in pressure which produces a blowing sound. It may also accompany the hissing sound as mentioned above. This is normal.</p> <p>After the start or stop of heating operation or during defrost operation, abrupt changes in temperature cause resin parts to shrink or expand. This is normal.</p> <p>It is the sound produced by the drain pump that discharges drain from indoor unit. The pump continues to run for 5 minutes after stopping the cooling operation. This is normal.</p> <p>Apply the damper sealant at the place considered to be the sources such as the pressure reducing mechanism. (Expansion valve, capillary tube, etc.)</p>

Note:

Error code Remote control: None 7-segment display:	LED	Green	Red	Content Excessive noise/vibration (3/3)
	Indoor	-	-	
	Outdoor	-	-	

1. Applicable model
All models
2. Error detection method
3. Condition of error displayed
4. Presumable cause

5. Troubleshooting	
Diagnosis	Countermeasure
<p>From 2/3</p>	<p>If insufficient cooling heating problem happens due to anomalous operating conditions at cooling /heating, followings are suspicious.</p> <ul style="list-style-type: none"> • Excessive charged amount of refrigerant • Insufficient charge amount of refrigerant • Intrusion of air, nitrogen, etc. <p>In such case, it is necessary to recover refrigerant, vacuum-dry and recharge refrigerant.</p> <p>* Since there could be many causes of noise/vibration, the above may not cover all. In such case, check the conditions when, where, how the noise/vibration occurs according to following check points and ask our consultation.</p> <ul style="list-style-type: none"> • Indoor/outdoor unit • Cooling/heating/fan mode • Startup/stop/during operation • Operating condition (Indoor/outdoor temperatures and pressures) • Time it occurred • Operation data retained by remote control or Mente PC such as compressor rotation speed, heat exchanger temperature, EEV opening degree and etc. • Tone (If available, record the noise) • Any other anomalies

Note:

Error code Remote control: None 7-segment display:	LED	Green	Red	Content <h2 style="text-align: center;">Louver motor anomaly</h2>
	Indoor	Keeps flashing	Stays Off	
	Outdoor	Keeps flashing	Stays Off	

1. Applicable model All models
2. Error detection method
3. Condition of error displayed
4. Presumable cause <ul style="list-style-type: none"> • Louver motor anomaly • Disconnection/breakage of LM harness • Limit switch anomaly

5. Troubleshooting

Diagnosis	Countermeasure
~Check at the indoor unit side.	
Operate after waiting for more than 1 minute.	
Does the louver operate when power on?	
YES	
NO	Is there any disconnection or breakage of LM connector?
	YES → Correct it.
	NO
	Is LM harness broken?
	YES → Repair harness.
	NO → Check connector (CnJ). Replace Louver Motor.
	Is LM locked?
	YES → Does LM turn smoothly?
	NO → Correct it.
	YES
	Is there any problem on the connection link?
	YES → Correct it.
	NO → Replace indoor unit control PCB.
	Is the setting of air flow direction change prohibited?
	YES → Correct it.
	NO
	Check the remote control whether it is fixed free flow setting.
In cases of FDTW, FDTS and FDTQ	
It is normal if LM can be stopped by pressing LS two times.	Check how LS reacts when the power is turned OFF and ON again
	NO
	Does the louver link press LS till crick sound can be heard?
	NO → Adjust LM lever and then check again.
	YES → <ul style="list-style-type: none"> • LS anomaly → Replace. • Indoor unit control PCB anomaly → Replace.
Notes (1) LM: Louver motor (2) LS: Limit switch	
In cases of FDT, FDTC, FDE and FDK	
Check the remote control whether it is fixed free flow setting or not.	

Note:

Error code Remote control: None 7-segment display:	LED	Green	Red	Content Power source system anomaly (Power source to indoor unit PCB)
	Indoor	Stays Off	Stays Off	
	Outdoor	Stays Off	2 times flash	

1. Applicable model
All models
2. Error detection method
3. Condition of error displayed
4. Presumable cause
<ul style="list-style-type: none"> • Wrong connection or breakage of connecting wires • Blown fuse • Transformer anomaly • Indoor unit power PCB anomaly • Broken harness • Indoor unit control PCB anomaly

5. Troubleshooting	
Diagnosis	Countermeasure
	<p>Outdoor noise filter PCB anomaly → Replace it.</p> <p>Wrong wiring or broken wires between outdoor and indoor units</p> <p>Indoor unit power PCB anomaly → Replace it.</p> <p>Replace FM, LM and etc.</p> <p>Replace fuse.</p> <p>Indoor unit power PCB anomaly → Replace it.</p> <p>Indoor unit control PCB anomaly → Replace it.</p> <p>Replace transformer.</p> <p>Indoor unit control PCB anomaly → Replace it.</p>

Note:

Error code Remote control: None 7-segment display:	LED	Green	Red	Content Power source system error (Power source to remote control)
	Indoor	Stays Off	Keeps lighting	
	Outdoor	Stays Off	Keeps lighting	

1. Applicable model All models
--

2. Error detection method

3. Condition of error displayed
--

4. Presumable cause <ul style="list-style-type: none"> • Remote control wire breakage/short-circuit • Remote control anomaly • Malfunction by noise • Indoor unit power PCB anomaly • Broken harness

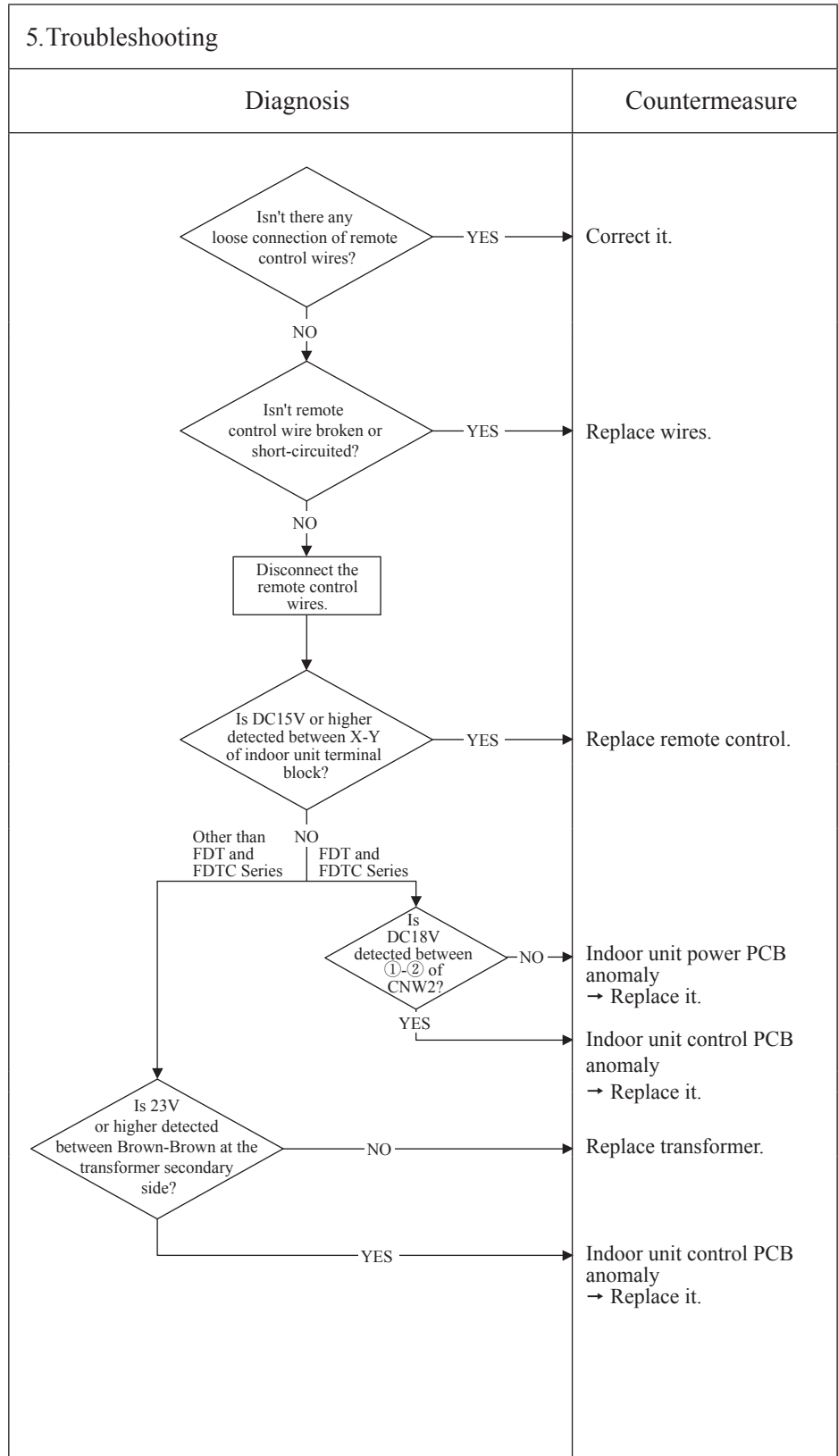

Note:

Error code	LED	Green	Red	Content
Remote control: WAIT 7-segment display:	Indoor	Keeps flashing	Stays Off	WAIT (1)
	Outdoor	Keeps flashing	Keeps flashing	

1. Applicable model

All models

(In case that WAIT is kept on displaying on the remote controller for more than 2 minutes after power ON)

2. Error detection method

3. Condition of error displayed

- 4. Presumable cause**
- Fuse blown
 - Noise filter anomaly
 - Anomalous connection of wire between PCBs
 - Indoor unit control PCB anomaly
 - Remote control anomaly
 - Breakage of connecting wires of remote control
 - Outdoor unit control PCB anomaly

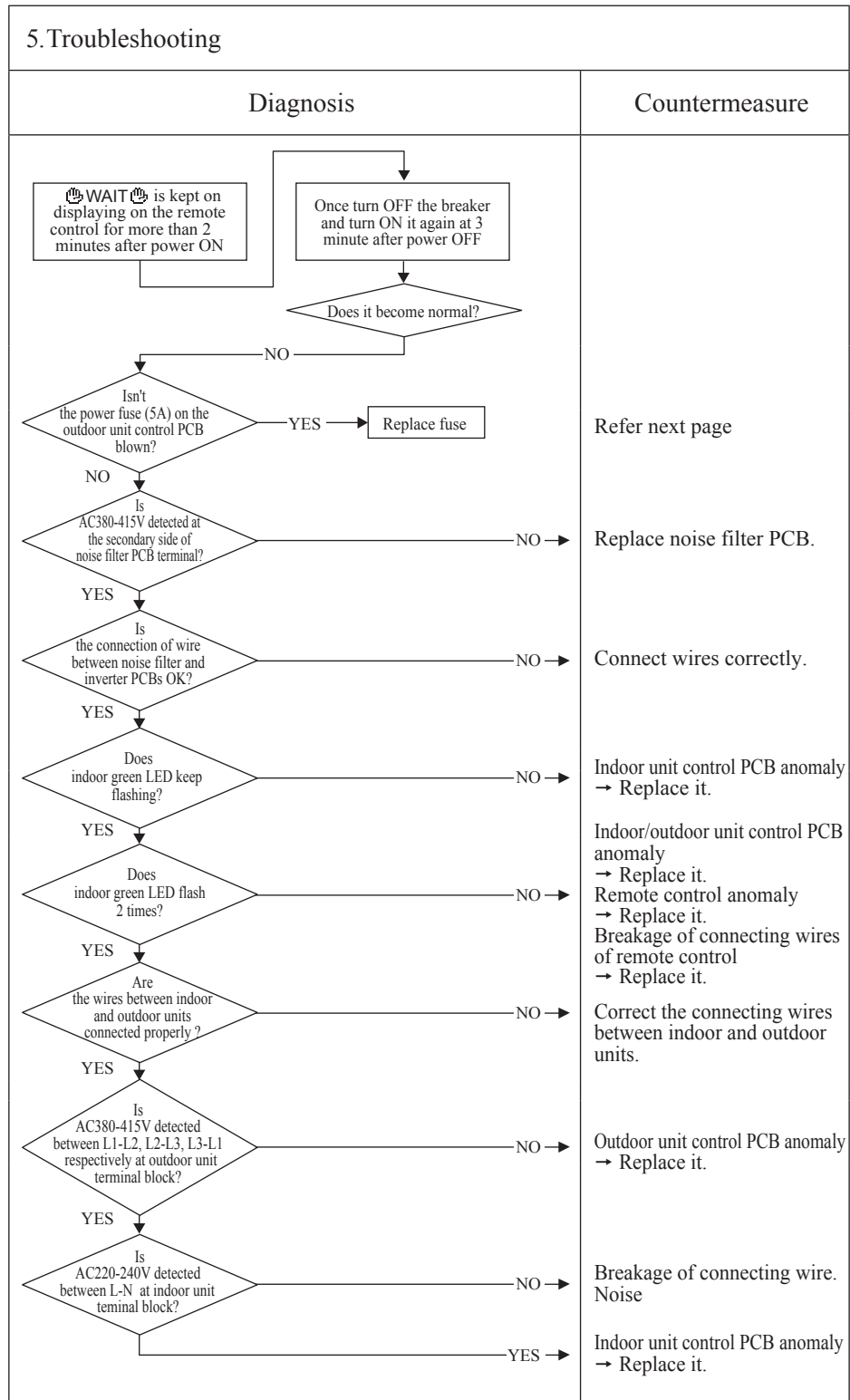

Note: (1) When anomaly occurs during establishing communication between indoor and outdoor unit, error code E5 is displayed (outdoor red LED flash 2-time)
In case of E5, the way of troubleshooting is same as above mentioned (except for checking of connecting wire)
When reset the power after E5 occurs, if this anomaly recurs, WAIT is displayed on remote control. If power ON/OFF is repeated in a short period (within 1 minute), WAIT may be displayed. In such case, please wait for 3 minute after the power breaker OFF.

(2) If any error is detected 30 minutes after displaying "WAIT" on the remote control, the display changes to "INSPECT I/U".

Error code Remote control: 🏠WAIT🏠 7-segment display:	LED	Green	Red	Content 🏠WAIT🏠 (2)
	Indoor	Keeps flashing	Stays Off	
	Outdoor	Keeps flashing	Keeps flashing	

<p>1. Applicable model</p> <p>All models (In case of fuse blown, how to check the unit before replacement of fuse)</p>	5. Troubleshooting		
<p>2. Error detection method</p>	Diagnosis	Countermeasure	
<p>3. Condition of error displayed</p>	<pre> graph TD Q1{Isn't there any short circuit between phases of noise filter?} Q2{Isn't there any crack or damage on power transistor module or diode stack?} Q3{Isn't there any anomaly on reactor?} R1[Replace noise filter] R2[Replace inverter PCB] R3[Replace reactor] R4[Replace fuse.] Q1 -- YES --> R1 R1 --> Q2 Q2 -- YES --> R2 R2 --> Q3 Q3 -- YES --> R3 R3 --> R4 Q1 -- NO --> Q2 Q2 -- NO --> Q3 Q3 -- NO --> R4 </pre>		<p>4. Presumable cause</p> <ul style="list-style-type: none"> • Fuse blown • Noise filter anomaly • Anomalous connection of wire between PCBs • Indoor unit control PCB anomaly • Remote control anomaly • Breakage of connecting wires of remote control • Outdoor unit control PCB anomaly

Note:

Error code Remote control: 📺 WAIT 📺 7-segment display:	LED	Green	Red	Content
	Indoor	Keeps flashing	Stays Off	
	Outdoor	Keeps flashing	Keeps flashing	

📺 WAIT 📺 (3)

1. Applicable model
All models (No display on the remote control after power ON)
2. Error detection method
3. Condition of error displayed
4. Presumable cause
<ul style="list-style-type: none"> • Fuse blown • Noise filter anomaly • Anomalous connection of wire between PCBs • Indoor unit control PCB anomaly • Remote control anomaly • Breakage of connecting wires of remote control • Outdoor unit control PCB anomaly

5. Troubleshooting	
Diagnosis	Countermeasure
<pre> graph TD Start[No display on the remote control after power ON] --> D1{Does indoor green LED keep flashing?} D1 -- NO --> D2{Is the fuse on indoor unit control PCB OK?} D2 -- NO --> C1[Fuse blown -> Replace fuse.] D2 -- YES --> D3{Is AC18V or higher detected between Red-Red at secondary side of indoor unit transformer? (1)} D3 -- NO --> C2[Transformer anomaly.] D3 -- YES --> D4{Is DC10-11V between X-Y at indoor unit control PCB side when removing remote control?} D4 -- NO --> C3[Remote control wire short-circuited.] D4 -- YES --> C4[Remote control anomaly.] D1 -- YES --> D5{Does outdoor red LED flash 2-times?} D5 -- NO --> C5[Indoor unit control PCB anomaly. Remote control anomaly. Breakage of connecting wires of remote control] D5 -- YES --> D6{Is the connecting wires between indoor and outdoor units connected properly?} D6 -- NO --> C6[Correct the connecting wires properly.] D6 -- YES --> D7{Is AC380-415V detected between L1-L2, L2-L3, L3-L1 respectively at outdoor unit terminal block?} D7 -- NO --> C7[Outdoor unit control PCB anomaly -> Replace it.] D7 -- YES --> D8{Is AC220-240V detected between L-N at indoor unit terminal block?} D8 -- NO --> C8[Breakage of connecting wire. Noise] D8 -- YES --> C9[Indoor unit control PCB anomaly -> Replace it.] </pre>	

Note:

Error code Remote control: WAIT 7-segment display:	LED	Green	Red	Content
	Indoor	Keeps flashing	Stays Off	
	Outdoor	Keeps flashing	Keeps flashing	

WAIT (4)

1. Applicable model All models (In case that WAIT is kept on displaying on the remote control for more than 2 minutes after power ON)
2. Error detection method
3. Condition of error displayed
4. Presumable cause <ul style="list-style-type: none"> • Fuse blown • Noise filter anomaly • Anomalous connection of wire between PCBs • Indoor unit control PCB anomaly • Remote control anomaly • Breakage of connecting wires of remote control • Outdoor unit control PCB anomaly

5. Troubleshooting	
Diagnosis	Countermeasure
<pre> graph TD Start[WAIT is kept on displaying on the remote control for more than 2 minutes after power ON] --> Q1{Does outdoor green LED keep flashing?} Q1 -- NO --> A[A] Q1 -- YES --> Q2{Does indoor green LED keep flashing?} Q2 -- NO --> C1[Indoor unit control PCB anomaly → Replace it.] Q2 -- YES --> Q3{Does outdoor red LED flash 2 times?} Q3 -- NO --> C2[Indoor unit control PCB anomaly → Replace it. Remote control anomaly → Replace it. Breakage of connecting wires of remote control → Replace it.] Q3 -- YES --> Q4{Are the wires between indoor and outdoor units connected properly?} Q4 -- NO --> C3[Correct the connecting wires between indoor and outdoor units.] Q4 -- YES --> Q5{Is AC380-415V detected between L1-L2, L2-L3, L3-L1 respectively at outdoor unit terminal block?} Q5 -- NO --> C4[Outdoor unit control PCB anomaly → Replace it.] Q5 -- YES --> Q6{Is AC220-240V detected between L-N at indoor unit terminal block?} Q6 -- NO --> C5[Breakage of connecting wire Noise] Q6 -- YES --> C6[Indoor unit control PCB anomaly → Replace it.] </pre>	Refer next page Indoor unit control PCB anomaly → Replace it. Indoor unit control PCB anomaly → Replace it. Remote control anomaly → Replace it. Breakage of connecting wires of remote control → Replace it. Correct the connecting wires between indoor and outdoor units. Outdoor unit control PCB anomaly → Replace it. Breakage of connecting wire Noise Indoor unit control PCB anomaly → Replace it.

Note:

Error code Remote control: 🏠WAIT🏠 7-segment display:	LED	Green	Red	Content 🏠WAIT🏠 (5)
	Indoor	Stays OFF	Stays Off	
	Outdoor	Stays OFF	Stays Off	

1. Applicable model

All models
(In case that LED on outdoor unit control PCB stays OFF)

2. Error detection method

3. Condition of error displayed

- 4. Presumable cause**
- Fuse blown
 - Noise filter anomaly
 - Anomalous connection of wire between PCBs
 - Indoor unit control PCB anomaly
 - Remote control anomaly
 - Breakage of connecting wires of remote control
 - Outdoor unit control PCB anomaly

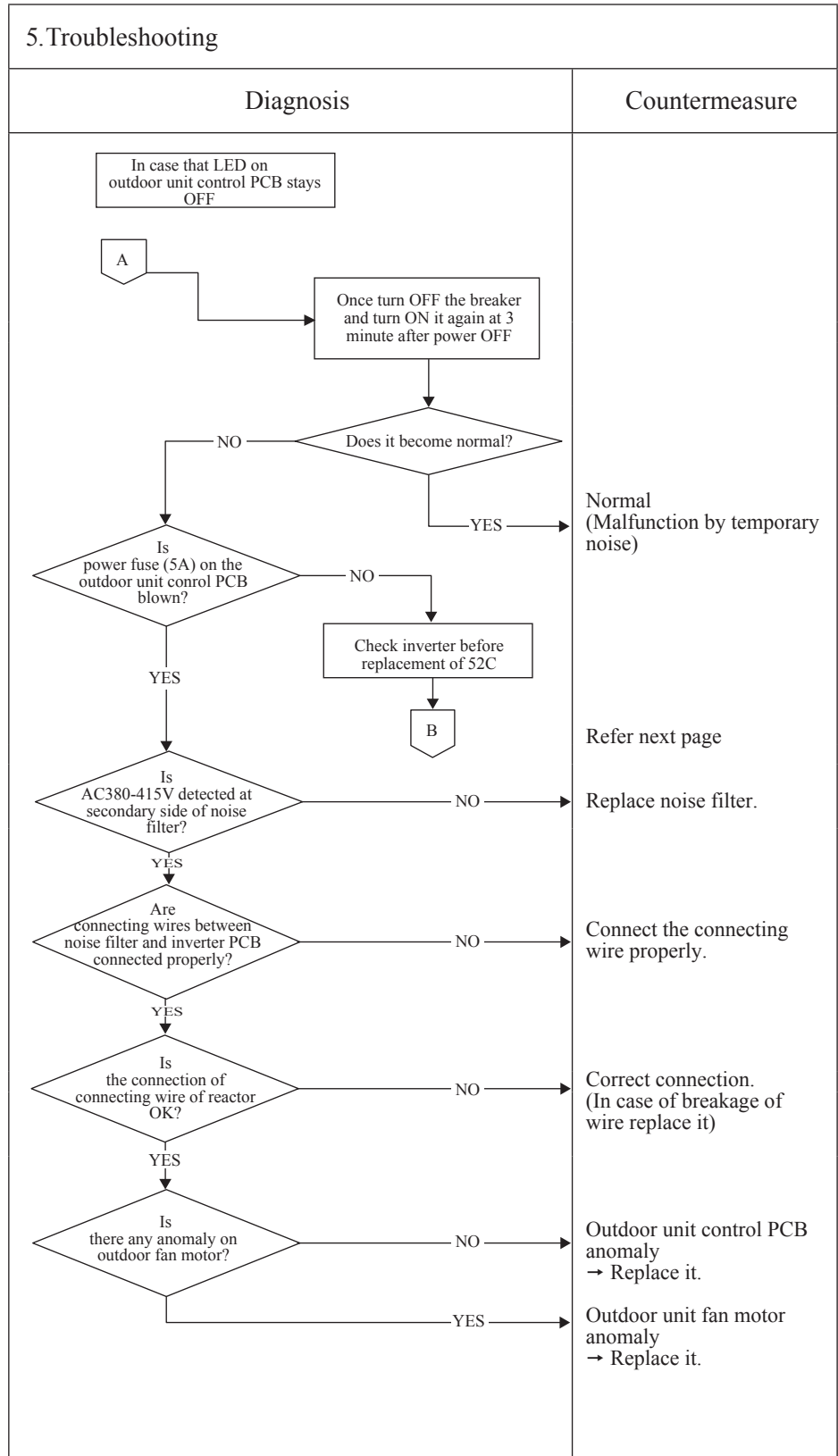

Note:

Error code Remote control: 🏠WAIT🏠 7-segment display:	LED	Green	Red	Content
	Indoor	Stays Off	Stays Off	
	Outdoor	Stays Off	Stays Off	

🏠WAIT🏠 (6)

1. Applicable model

All models

(In case of fuse blown, how to check the unit before replacement of fuse)

2. Error detection method

3. Condition of error displayed

- 4. Presumable cause**
- Fuse blown
 - Noise filter anomaly
 - Anomalous connection of wire between PCBs
 - Indoor unit control PCB anomaly
 - Remote control anomaly
 - Breakage of connecting wires of remote control
 - Outdoor unit control PCB anomaly

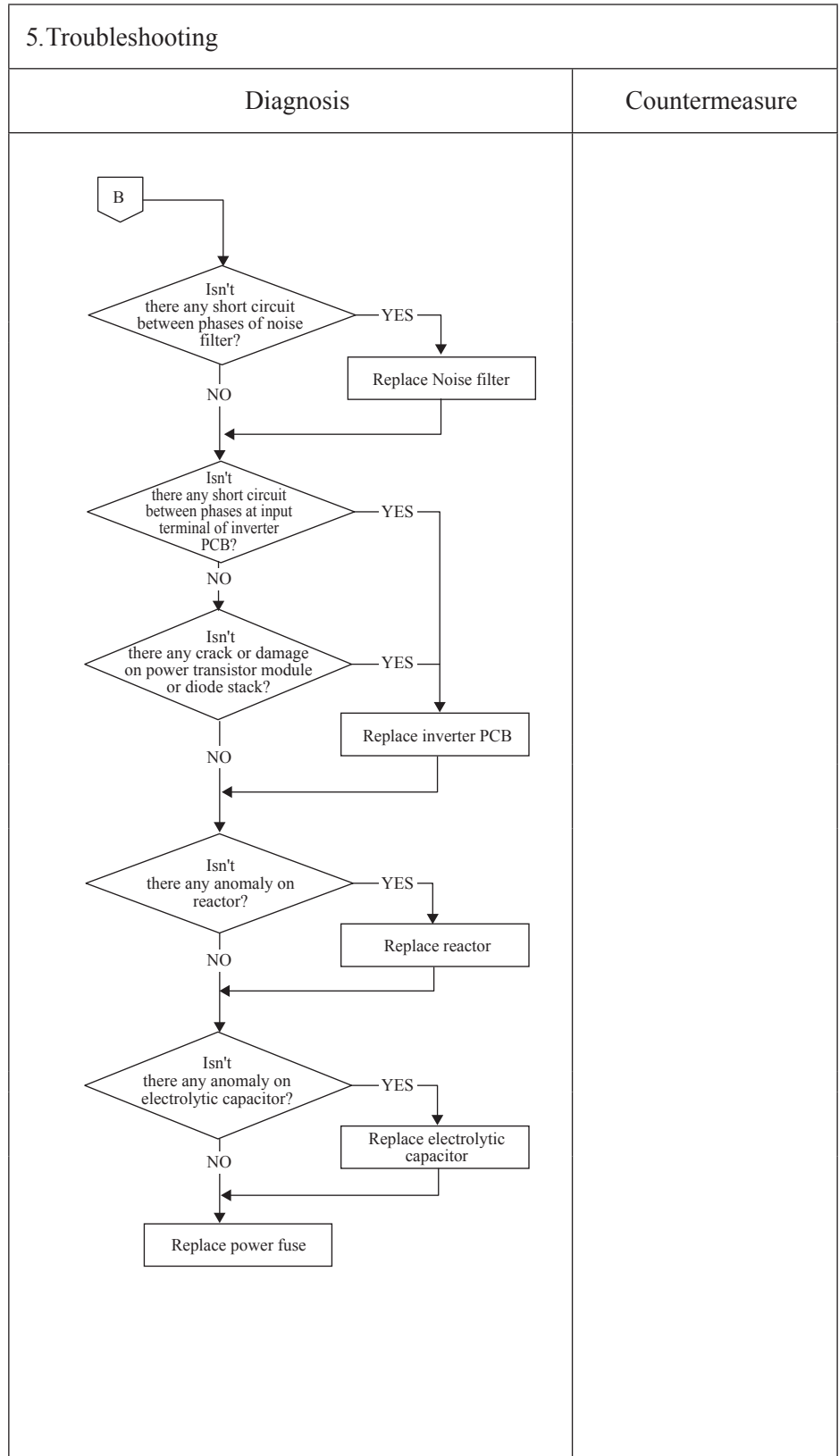

Note:

Error code Remote control: [No display] 7-segment display:	LED	Green	Red	Content [No display]
	Indoor	Stays OFF	Stays Off	
	Outdoor	Stays OFF	Stays Off	

1. Applicable model
All models
(No display on the remote control after power ON)

2. Error detection method

3. Condition of error displayed

4. Presumable cause

- Fuse blown
- Noise filter anomaly
- Anomalous connection of wire between PCBs
- Indoor unit control PCB anomaly
- Remote control anomaly
- Breakage of connecting wires of remote control
- Outdoor unit control PCB anomaly

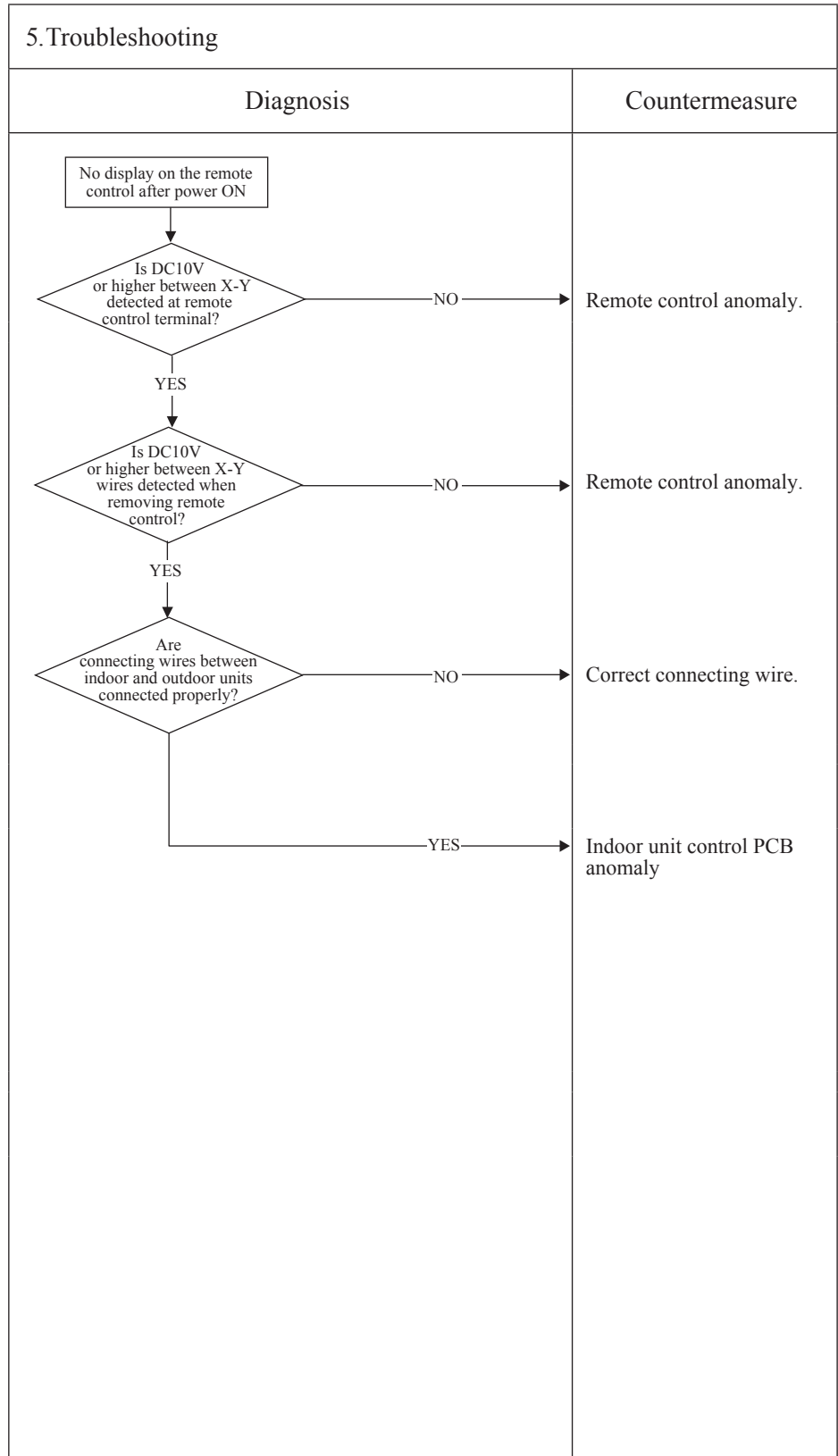

Note:

Error code Remote control: E1 7-segment display: -	LED	Green	Red	Content <h2 style="text-align: center;">Remote control communication error</h2>
	Indoor	Keeps flashing	Stays Off	
	Outdoor	Keeps flashing	Stays Off	

1. Applicable model
All models
2. Error detection method
When normal communication between remote control and indoor unit is interrupted for more than 2 minutes (Detectable only with the remote control)
3. Condition of error displayed
Same as above
4. Presumable cause
<ul style="list-style-type: none"> • Anomalous communication circuit between remote control and indoor unit • Noise

5. Troubleshooting	
Diagnosis	Countermeasure
<pre> graph TD Q1{Is it possible to reset normally by the power source reset? (2)} Q1 -- YES --> C1[Malfunction by temporary noise. Check peripheral environment.] Q1 -- NO --> P1[Turn SW7-1 OFF. → ON Disconnect the wire ③ between indoor and outdoor units] P1 --> P2[Reset power source] P2 --> Q2{Does the drain pump start automatically at one minutes after power ON?} Q2 -- YES --> C2[Indoor unit control PCB anomaly → Replace it.] Q2 -- NO --> C3[Remote control anomaly → Replace it.] Note2[Note (2) Does the remote control displays "Internal check ON" even after 3 minutes?] </pre> <p>Note (1) SW7-1: OFF → ON</p> <p>Note (2) Does the remote control displays "Internal check ON" even after 3 minutes?</p>	

Note: If the indoor unit cannot communicate normally with the remote control for 180 seconds, the indoor unit PCB starts to reset automatically.

Error code Remote control: E2 7-segment display: -	LED	Green	Red	Content <h2 style="text-align: center;">Duplicated indoor unit address</h2>
	Indoor	Keeps flashing	Keeps flashing	
	Outdoor	Keeps flashing	Stays Off	

1. Applicable model

All models

2. Error detection method

More than 129 indoor units are connected in the same Superlink system.
 Duplicated indoor unit address

3. Condition of error displayed

Same as above

4. Presumable cause

- Number of connected indoor units exceeds the limitation.
- Duplicated indoor unit address
- Indoor unit control PCB anomaly

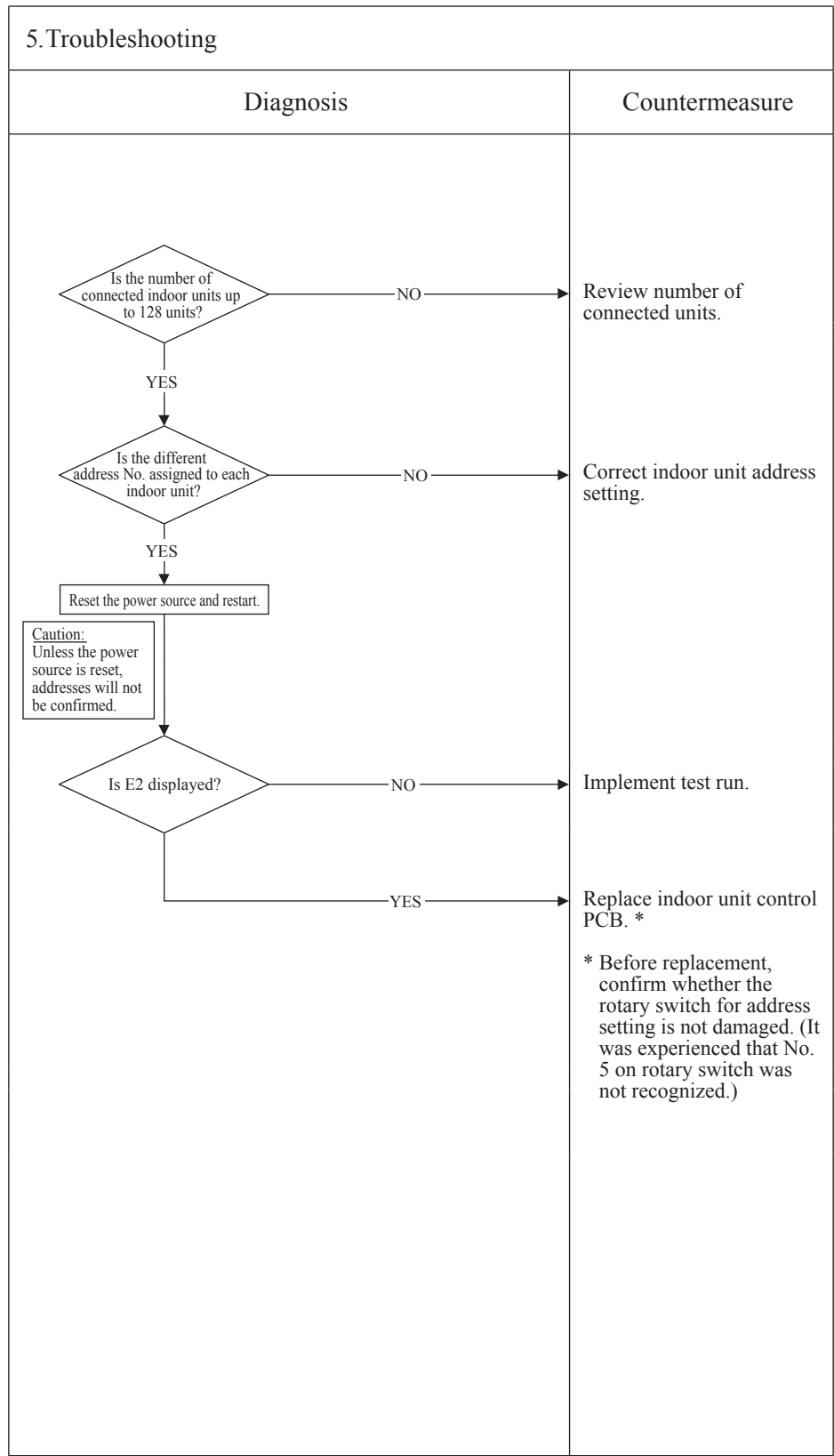

Note:

Error code Remote control: E3/5 7-segment display: -	LED	Green	Red	Content <h2 style="text-align: center;">Outdoor unit signal line error</h2>
	Indoor	Keeps flashing	2 times flash	
	Outdoor	Keeps flashing	Stays Off	

1. Applicable model
All models

2. Error detection method
No outdoor unit exists in the same Superlink system.

3. Condition of error displayed
Same as above

4. Presumable cause
<ul style="list-style-type: none"> • Power is not supplied to the outdoor unit • Unmatch of pairing between indoor and outdoor units • Indoor unit control PCB anomaly • Outdoor unit control PCB anomaly • Missing local wiring

5. Troubleshooting	
Diagnosis	Countermeasure
<p>E3 is a communication error that occurs when communication between indoor and outdoor units is not established at all. Once the communication between indoor and outdoor units is established, it changes to E5. In both cases, check signal wires (between indoor-outdoor units) locally.</p>	
Reset the power source and restart.	
Does E3/E5 occurs?	NO → Temporary malfunction by noise. Identify the source of noise and correct it.
YES	
Is protective fuse for the Superlink circuit blown?	YES → Change to spare circuit.
NO	
Is the LED on indoor unit control PCB OK?	NO → Indoor unit control PCB anomaly → Replace it.
YES	
Is the power source to outdoor unit OK?	NO → Correct it.
YES	
Is the outdoor unit address set on the indoor unit OK?	NO → Correct it.
YES	
Is the signal wires (between indoor - outdoor units) connection OK?	NO → Correct it.
YES	Outdoor unit control PCB anomaly → Replace it.

Note:

Error code Remote control: E5 7-segment display: -	LED	Green	Red	Content <h2 style="text-align: center;">Communication error during operation</h2>
	Indoor	Keeps flashing	*See below	
	Outdoor	Keeps flashing	2 time flash	

1. Applicable model
All models
2. Error detection method
When the communication between indoor and outdoor units is interrupted for more than 2 minutes
3. Condition of error displayed
When this anomaly is detected during operation.
4. Presumable cause
<ul style="list-style-type: none"> • Unit address No. setting error • Remote control wires broken • Poor connection/disconnection of remote control wires • Indoor unit control PCB anomaly

5. Troubleshooting	
Diagnosis	Countermeasure
<p>* In case that indoor unit red LED flashes 2 times</p> <p>Note (1) Check the connection (disconnection, looseness) of signal wires at outdoor unit terminal block</p> <p>Is the connection of signal wires at the outdoor unit side OK?</p> <p>NO → Repair signal wires.</p> <p>YES</p> <p>Note (2) Check the connection (disconnection, looseness, brackage) of signal wires (between indoor and outdoor units)</p> <p>Is the connection of signal wires (between indoor and outdoor units) OK?</p> <p>NO → Repair signal wires.</p> <p>YES</p> <p>Reset the power source and restart.</p> <p>Does the remote control LCD becomes normal?</p> <p>NO → Go to the diagnosis of WAIT (1).</p> <p>YES → Unit is normal. (Malfunction by temporary noise, etc.)</p> <p>* In case that indoor unit red LED stays OFF</p> <p>Reset the power source and restart.</p> <p>Does the remote control LCD becomes normal?</p> <p>NO → Outdoor unit control PCB anomaly (Network communication circuit anomaly) → Replace it.</p> <p>YES → Unit is normal. (Malfunction by temporary noise, etc.)</p>	

Note: When the pump down switch is turned on, communication between indoor and outdoor units is cancelled so that "Communication error E5" will be displayed on the remote control and indoor unit control PCB, but this is normal.

Error code Remote control: E6 7-segment display: -	LED	Green	Red	Content Indoor unit heat exchanger temperature sensor anomaly (Thi-R)
	Indoor	Keeps flashing	1 time flash	
	Outdoor	Keeps flashing	Stays Off	

1. Applicable model

All models

2. Error detection method

Detection of anomalously low temperature (resistance) of Thi-R1, R2, R3

3. Condition of error displayed

- If -50°C or lower is detected for 5 seconds continuously, compressor stops. After 3 minutes delay, the compressor is restarted automatically, but if this anomaly occurs again within 60 minutes after the initial detection.
- Or if 70°C or higher is detected for 5 seconds continuously.

4. Presumable cause

- Anomalous connection of indoor unit heat exchanger temperature sensor
- Indoor unit heat exchanger temperature sensor anomaly
- Indoor unit control PCB anomaly

5. Troubleshooting

Diagnosis	Countermeasure																
<pre> graph TD Q1{Is the connector of sensor connected properly?} -- NO --> C1[Insert the connector securely.] Q1 -- YES --> Q2{Are the characteristics of sensor OK? *1} Q2 -- NO --> C2[Replace sensor (Thi-R).] Q2 -- YES --> C3[Replace indoor unit control PCB.] </pre> <p>*1 Check several times to prove any poor connection</p>																	
<p>Temperature-resistance characteristics of indoor unit heat exchanger temperature sensor (Thi-R1, R2, R3)</p> <table border="1"> <caption>Approximate data points from the graph</caption> <thead> <tr> <th>Temperature (°C)</th> <th>Resistance (kΩ)</th> </tr> </thead> <tbody> <tr><td>0</td><td>15</td></tr> <tr><td>10</td><td>10</td></tr> <tr><td>20</td><td>6</td></tr> <tr><td>25</td><td>5</td></tr> <tr><td>30</td><td>4</td></tr> <tr><td>40</td><td>3</td></tr> <tr><td>50</td><td>2</td></tr> </tbody> </table>	Temperature (°C)	Resistance (kΩ)	0	15	10	10	20	6	25	5	30	4	40	3	50	2	
Temperature (°C)	Resistance (kΩ)																
0	15																
10	10																
20	6																
25	5																
30	4																
40	3																
50	2																

Note:

Error code Remote control: E7 7-segment display: -	LED	Green	Red	Content Indoor return air temperature sensor anomaly (Thi-A)
	Indoor	Keeps flashing	1 time flash	
	Outdoor	Keeps flashing	Stays Off	

1. Applicable model

All models

2. Error detection method

Detection of anomalously low temperature (resistance) of Thi-A

3. Condition of error displayed

- If -50°C or lower is detected for 5 seconds continuously, compressor stops. After 3 minutes delay the compressor is restarted automatically, but if this anomaly occurs again within 60 minutes after the initial detection.
- Or if 48°C or higher is detected for 5 seconds continuously.

4. Presumable cause

- Anomalous connection of indoor return air temperature sensor
- Indoor return air temperature sensor anomaly
- Indoor unit control PCB anomaly

5. Troubleshooting

Diagnosis	Countermeasure																
<pre> graph TD Q1{Is the connector of sensor connected properly?} -- NO --> C1[Insert the connector securely.] Q1 -- YES --> Q2{Are the characteristics of sensor OK? *1} Q2 -- NO --> C2[Replace sensor (Thi-A).] Q2 -- YES --> C3[Replace indoor unit control PCB.] </pre> <p>*1 Check several times to prove any poor connection</p>																	
<p>Temperature-resistance characteristics of indoor return air temperature sensor (Thi-A)</p> <table border="1"> <caption>Temperature-resistance characteristics of indoor return air temperature sensor (Thi-A)</caption> <thead> <tr> <th>Temperature (°C)</th> <th>Temperature sensor resistance (kΩ)</th> </tr> </thead> <tbody> <tr> <td>0</td> <td>~15</td> </tr> <tr> <td>10</td> <td>~10</td> </tr> <tr> <td>20</td> <td>~6</td> </tr> <tr> <td>25</td> <td>5</td> </tr> <tr> <td>30</td> <td>~4</td> </tr> <tr> <td>40</td> <td>~3</td> </tr> <tr> <td>50</td> <td>~2</td> </tr> </tbody> </table>	Temperature (°C)	Temperature sensor resistance (kΩ)	0	~15	10	~10	20	~6	25	5	30	~4	40	~3	50	~2	
Temperature (°C)	Temperature sensor resistance (kΩ)																
0	~15																
10	~10																
20	~6																
25	5																
30	~4																
40	~3																
50	~2																

Note:

Error code Remote control: E9 7-segment display: -	LED	Green	Red	Content
	Indoor	Keeps flashing	1 time flash	
	Outdoor	Keeps flashing	Stays Off	

Drain trouble

1. Applicable model FDT, FDTC, FDTW, FDTQ, FDTS, FDR, FDU, FDUM, and FDQS series
2. Error detection method Float switch is activated
3. Condition of error displayed If the float switch OPEN is detected for 3 seconds continuously or if float switch connector is disconnected or wire broken.
4. Presumable cause <ul style="list-style-type: none"> Indoor unit control PCB anomaly Mistake in setting of float switch Mistake in setting of humidifier drain pump motor interlock Mistake in setting of option equipment Mistake in drain piping Drain pump motor anomaly Disconnection/breakage of drain pump motor wires

5. Troubleshooting	
Diagnosis	Countermeasure
<pre> graph TD Start[Check the error data in the remote control.] --> Q1{Is there any overflow?} Q1 -- NO --> Q2{Is DC 12V detected at CnI connector?} Q2 -- YES --> C1[Check float switch.] Q2 -- NO --> Q3{Is the CnI connected firmly?} Q3 -- NO --> C2[Check the connection of CnI. If it is loose, connect it securely.] Q3 -- YES --> Q4{Is there any anomaly on the option equipment?} Q4 -- NO --> C3[Replace indoor unit control PCB.] Q4 -- YES --> C4[Check option equipment.] Q1 -- YES --> Q5{Is the humidifier connected?} Q5 -- NO --> C3 Q5 -- YES --> Q6{Is the humidifier drain pump motor interlocked by the indoor unit function setting of remote control?} Q6 -- NO --> C3 Q6 -- YES --> Start2[Drain pump motor ON from the remote control.] Start2 --> Q7{Does the drain pump motor operate?} Q7 -- NO --> Q8{Is AC220/240V detected at CnR?} Q8 -- NO --> C5[Indoor unit control PCB anomaly -> Replace it.] Q8 -- YES --> C6[Check the wiring of drain pump motor.] Q7 -- YES --> Q9{Is the drain piping unclogged? Is the drain pipe slope OK?} Q9 -- NO --> C7[Correct it.] Q9 -- YES --> C8[Check drain pump motor.] </pre>	Countermeasure actions corresponding to the flowchart steps.

Note: When this anomaly occurs at power ON, disconnection of connector or breakage of wire of float switch is suspected. Check and correct it (or replace it, if necessary).

Error code Remote control: E10 7-segment display: -	LED	Green	Red	Content Excessive number of indoor units (more than 17 units) by controlling one remote control
	Indoor	Keeps flashing	Stays Off	
	Outdoor	Keeps flashing	Stays Off	

<p>1. Applicable model</p> <p>All models</p>	<p>5. Troubleshooting</p> <table border="1" style="width: 100%;"> <thead> <tr> <th style="width: 50%;">Diagnosis</th> <th style="width: 50%;">Countermeasure</th> </tr> </thead> <tbody> <tr> <td style="text-align: center;"> <pre> graph TD A{Aren't more than 17 indoor units connected to one remote control?} -- NO --> B[Remote control anomaly → Replace it.] A -- YES --> C[Reduce to 16 or less units.] </pre> </td> <td></td> </tr> </tbody> </table>		Diagnosis	Countermeasure	<pre> graph TD A{Aren't more than 17 indoor units connected to one remote control?} -- NO --> B[Remote control anomaly → Replace it.] A -- YES --> C[Reduce to 16 or less units.] </pre>	
Diagnosis	Countermeasure					
<pre> graph TD A{Aren't more than 17 indoor units connected to one remote control?} -- NO --> B[Remote control anomaly → Replace it.] A -- YES --> C[Reduce to 16 or less units.] </pre>						
<p>2. Error detection method</p> <p>When it detects more than 17 of indoor units connected to one remote control</p>						
<p>3. Condition of error displayed</p> <p>Same as above</p>						
<p>4. Presumable cause</p> <ul style="list-style-type: none"> • Excessive number of indoor units connected. • Remote control anomaly. 						

Note:

Error code Remote control: E12 7-segment display: -	LED	Green	Red	Content <h2 style="text-align: center;">Address setting error by mixed setting method</h2>
	Indoor	Keeps flashing	Keeps flashing	
	Outdoor	Keeps flashing	Stays Off	

1. Applicable model
All models

2. Error detection method
Automatic address setting and manual address setting are mixed when setting address of indoor units

3. Condition of error displayed
Same as above

4. Presumable cause
Mistake in address setting for indoor unit

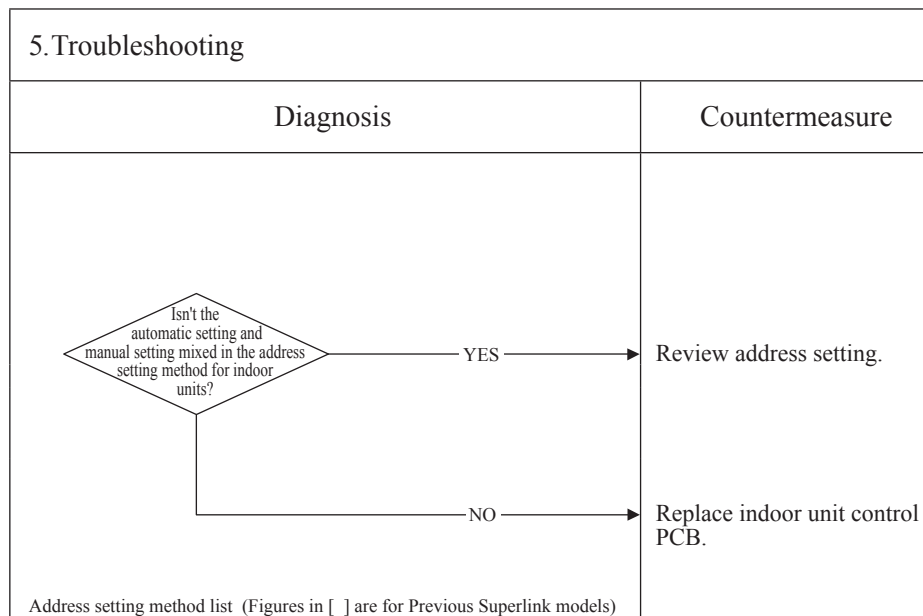

Address setting method list (Figures in [] are for Previous Superlink models)

		Models for new Superlink protocol			Models for Previous Superlink protocol		
		Indoor unit address setting		Outdoor unit address setting	Indoor unit address setting		Outdoor unit address setting
		Indoor unit No. switch	Outdoor unit No. switch	Outdoor unit No. switch	Indoor unit No. switch	Outdoor unit No. switch	Outdoor unit No. switch
Manual address setting	(New SL)	000-127	00-31	00-31	00-47	00-47	00-47
	(Previous SL)	[00-47]	[00-47]	[00-47]			
Automatic address setting for single refrigerant system	(New SL)	000	49	49	49	49	49
	(Previous SL)						
Automatic address setting for multiple refrigerant systems	(New SL)	000	49	00-31	Not available		
	(Previous SL)	Not available					

Note:

Error code Remote control: E16 7-segment display: -	LED	Green	Red	Content <h2 style="text-align: center;">Indoor fan motor anomaly (FDT series)</h2>
	Indoor	Keeps flashing	1 time flash	
	Outdoor	Keeps flashing	Stays Off	

1. Applicable model
FDT series only

2. Error detection method
Detected by revolution speed of indoor fan motor

3. Condition of error displayed
When actual revolution speed of indoor fan motor drops to lower than 200min ⁻¹ for 30 seconds continuously, the compressor and the indoor fan motor stop. After 2 seconds delay, fan motor starts again automatically, but if this anomaly occurs 4 times within 60 minutes after the initial detection.

4. Presumable cause
<ul style="list-style-type: none"> • Indoor fan motor anomaly • Foreign matter at rotational area of fan propeller • Fan motor anomaly • Dust on control PCB • Blown fuse • External noise, surge

5. Troubleshooting	
Diagnosis	Countermeasure
<pre> graph TD Q1{Does any foreign matter intervene in rotational area of fan?} -- YES --> C1[Remove foreign matter.] Q1 -- NO --> Q2{Does the fan rotate smoothly when turned by hand?} Q2 -- YES --> Q3{Is DC280V detected between ①-④ of fan motor connector CnM?} Q2 -- NO --> C2[Replace the fan motor.] Q3 -- YES --> Q4{Is the fuse F202 blown?} Q3 -- NO --> C3[Check power source voltage.] Q4 -- YES --> C4[Replace fan motor and power PCB.] Q4 -- NO --> Q5{Does it become normal?} Q5 -- YES --> C5[Malfunction by temporary noise] Q5 -- NO --> C6[Replace fan motor. (If the anomaly persists after replacing the fan motor, replace the indoor unit control PCB.)] </pre>	

Note:

Error code Remote control: E16 7-segment display: -	LED	Green	Red	Content Indoor fan motor anomaly (FDK series)
	Indoor	Keeps flashing	1 time flash	
	Outdoor	Keeps flashing	Stays Off	

1. Applicable model
 FDK series only

2. Error detection method
 Detected by revolution speed of indoor fan motor

3. Condition of error displayed
 When actual revolution speed of indoor fan motor drops to lower than 200min⁻¹ for 30 seconds continuously, the compressor and the indoor fan motor stop. After 3 seconds delay, fan motor starts again automatically, but if this anomaly occurs 4 times within 60 minutes after the initial detection.

- 4. Presumable cause**
- Indoor fan motor anomaly
 - Foreign matter at rotational area of fan impeller
 - Fan motor anomaly
 - Dust on control PCB
 - Blown fuse
 - External noise, surge

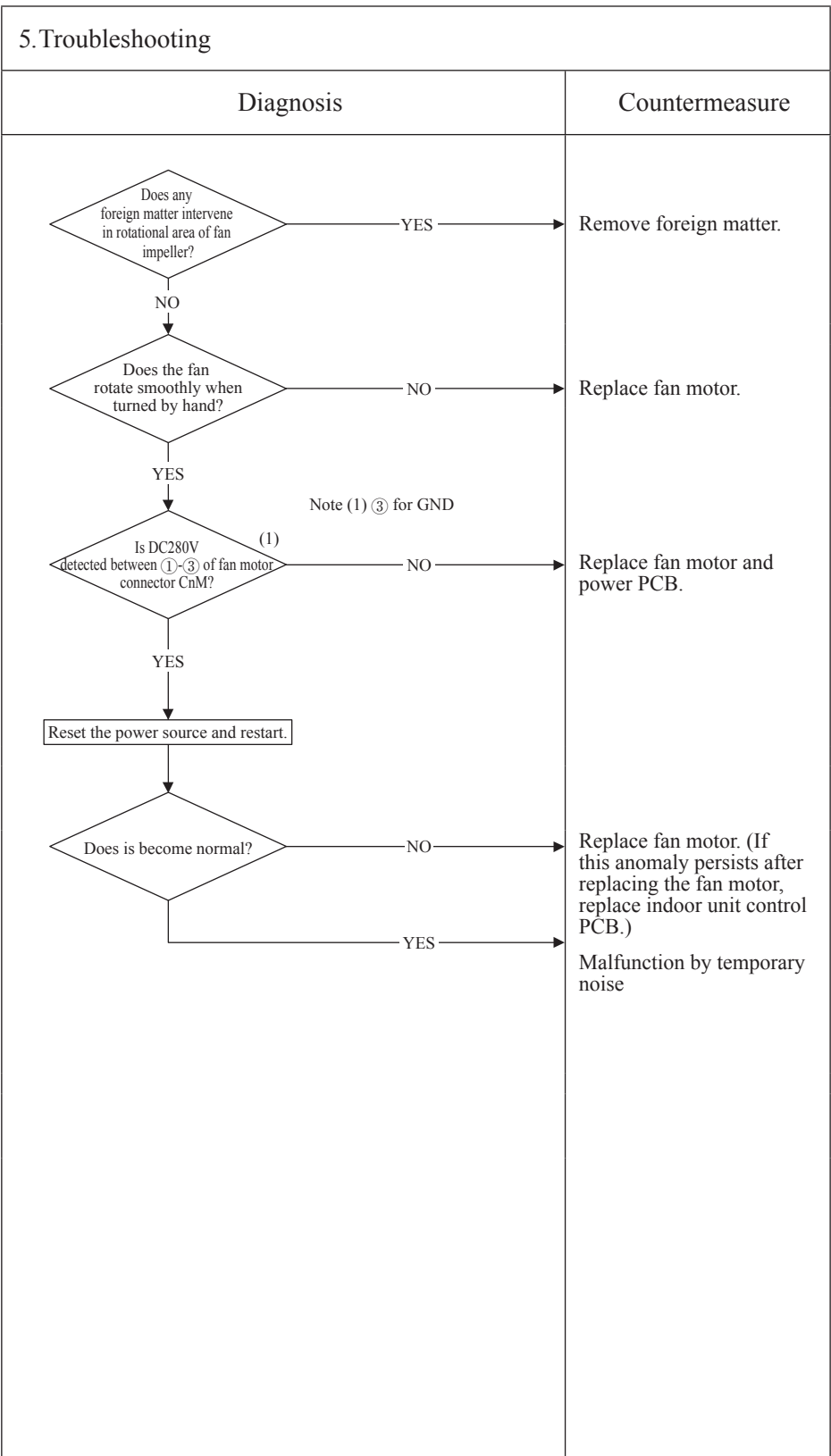

Note:

Error code Remote control: E19 7-segment display: -	LED	Green	Red	Content Indoor unit operation check, drain pump motor check mode anomaly
	Indoor	Keeps flashing	1 time flash	
	Outdoor	Keeps flashing	Stays Off	

1. Applicable model	5. Troubleshooting		
All models	Diagnosis	Countermeasure	
2. Error detection method	<pre> graph TD Start[E19 occurs when the power ON] --> Decision{Is SW7-1 on the indoor unit control PCB ON?} Decision -- YES --> Countermeasure1[Turn SW7-1 on the indoor unit control PCB OFF and reset the power.] Decision -- NO --> Countermeasure2[Indoor unit control PCB anomaly (Anomalous SW7) -> Replace.] </pre>		
E19 occurs			
3. Condition of error displayed			
Same as above			
4. Presumable cause	Mistake in SW7-1 setting Due to forgetting to turn OFF SW7-1 after indoor unit operation check)		

Note: Indoor unit operation check/drain pump check mode
 If the power is ON after SW7-1ON, indoor unit operation check/drain pump check mode can be established.

- 1) When the communication between remote control and indoor unit PCB is established 15 seconds after power ON, it goes to indoor unit operation check.
- 2) When the communication between remote control and indoor unit PCB is not established, it goes to drain pump check (CnB connector should be open before power ON)

Error code Remote control: E28 7-segment display: -	LED	Green	Red	Content <h2 style="text-align: center;">Remote control temperature sensor anomaly (Thc)</h2>
	Indoor	Keeps flashing	Stays Off	
	Outdoor	Keeps flashing	Stays Off	

1. Applicable model

All models

2. Error detection method

Detection of anomalously low temperature (resistance) of Thc

3. Condition of error displayed

- If -50°C or lower is detected for 5 seconds continuously, compressor stops. After 3 minutes delay, the compressor is restarted automatically, but if this anomaly occurs again within 60 minutes after the initial detection.

4. Presumable cause

- Anomalous connection of remote control temperature sensor
- Remote control temperature sensor anomaly
- Remote control PCB anomaly

5. Troubleshooting

Diagnosis	Countermeasure																																																																								
<pre> graph TD Q1{Is the connector of sensor connected properly?} -- NO --> C1[Insert the connector securely.] Q1 -- YES --> Q2{Are the characteristics of sensor OK? Is the sensor wire OK *1?} Q2 -- NO --> C2[Replace sensor (Thc).] Q2 -- YES --> C3[Replace indoor unit control PCB.] </pre>																																																																									
<p>*1 Check several times to prove any poor connection</p> <p>Temperature-resistance characteristics of remote control temperature sensor (Thc)</p> <table border="1" style="width: 100%; border-collapse: collapse;"> <thead> <tr> <th>Temperature (°C)</th> <th>Resistance (kΩ)</th> <th>Temperature (°C)</th> <th>Resistance (kΩ)</th> <th>Temperature (°C)</th> <th>Resistance (kΩ)</th> <th>Temperature (°C)</th> <th>Resistance (kΩ)</th> </tr> </thead> <tbody> <tr><td>0</td><td>65</td><td>14</td><td>33</td><td>30</td><td>16</td><td>46</td><td>8.5</td></tr> <tr><td>1</td><td>62</td><td>16</td><td>30</td><td>32</td><td>15</td><td>48</td><td>7.8</td></tr> <tr><td>2</td><td>59</td><td>18</td><td>27</td><td>34</td><td>14</td><td>50</td><td>7.3</td></tr> <tr><td>4</td><td>53</td><td>20</td><td>25</td><td>36</td><td>13</td><td>52</td><td>6.7</td></tr> <tr><td>6</td><td>48</td><td>22</td><td>23</td><td>38</td><td>12</td><td>54</td><td>6.3</td></tr> <tr><td>8</td><td>44</td><td>24</td><td>21</td><td>40</td><td>11</td><td>56</td><td>5.8</td></tr> <tr><td>10</td><td>40</td><td>26</td><td>19</td><td>42</td><td>9.9</td><td>58</td><td>5.4</td></tr> <tr><td>12</td><td>36</td><td>28</td><td>18</td><td>44</td><td>9.2</td><td>60</td><td>5.0</td></tr> </tbody> </table>		Temperature (°C)	Resistance (kΩ)	Temperature (°C)	Resistance (kΩ)	Temperature (°C)	Resistance (kΩ)	Temperature (°C)	Resistance (kΩ)	0	65	14	33	30	16	46	8.5	1	62	16	30	32	15	48	7.8	2	59	18	27	34	14	50	7.3	4	53	20	25	36	13	52	6.7	6	48	22	23	38	12	54	6.3	8	44	24	21	40	11	56	5.8	10	40	26	19	42	9.9	58	5.4	12	36	28	18	44	9.2	60	5.0
Temperature (°C)	Resistance (kΩ)	Temperature (°C)	Resistance (kΩ)	Temperature (°C)	Resistance (kΩ)	Temperature (°C)	Resistance (kΩ)																																																																		
0	65	14	33	30	16	46	8.5																																																																		
1	62	16	30	32	15	48	7.8																																																																		
2	59	18	27	34	14	50	7.3																																																																		
4	53	20	25	36	13	52	6.7																																																																		
6	48	22	23	38	12	54	6.3																																																																		
8	44	24	21	40	11	56	5.8																																																																		
10	40	26	19	42	9.9	58	5.4																																																																		
12	36	28	18	44	9.2	60	5.0																																																																		

Note: After 10 seconds has elapsed since remote control temperature sensor was switched from invalid to valid, E28 will not be displayed even if the sensor harness is disconnected or broken. However, in such case, the indoor return air temperature sensor (Thi-A) will be valid instantly instead of the remote control temperature sensor (Thc). Please note that even though the remote control temperature sensor (Thc) is valid, the displayed return air temperature on the remote control LCD shows the value detected by the indoor return air temperature sensor (Thi-A), not by the remote control temperature sensor (Thc).

Error code Remote control: E30 7-segment display: E30	LED	Green	Red	Content Unmatch connection of indoor and outdoor unit
	Indoor	Keeps flashing	Stays Off	
	Outdoor	Keeps flashing	1 time flash	

1. Applicable model

Outdoor unit

2. Error detection method

3. Condition of error displayed

4. Presumable cause

- Indoor unit control PCB anomaly
- Outdoor unit control PCB anomaly

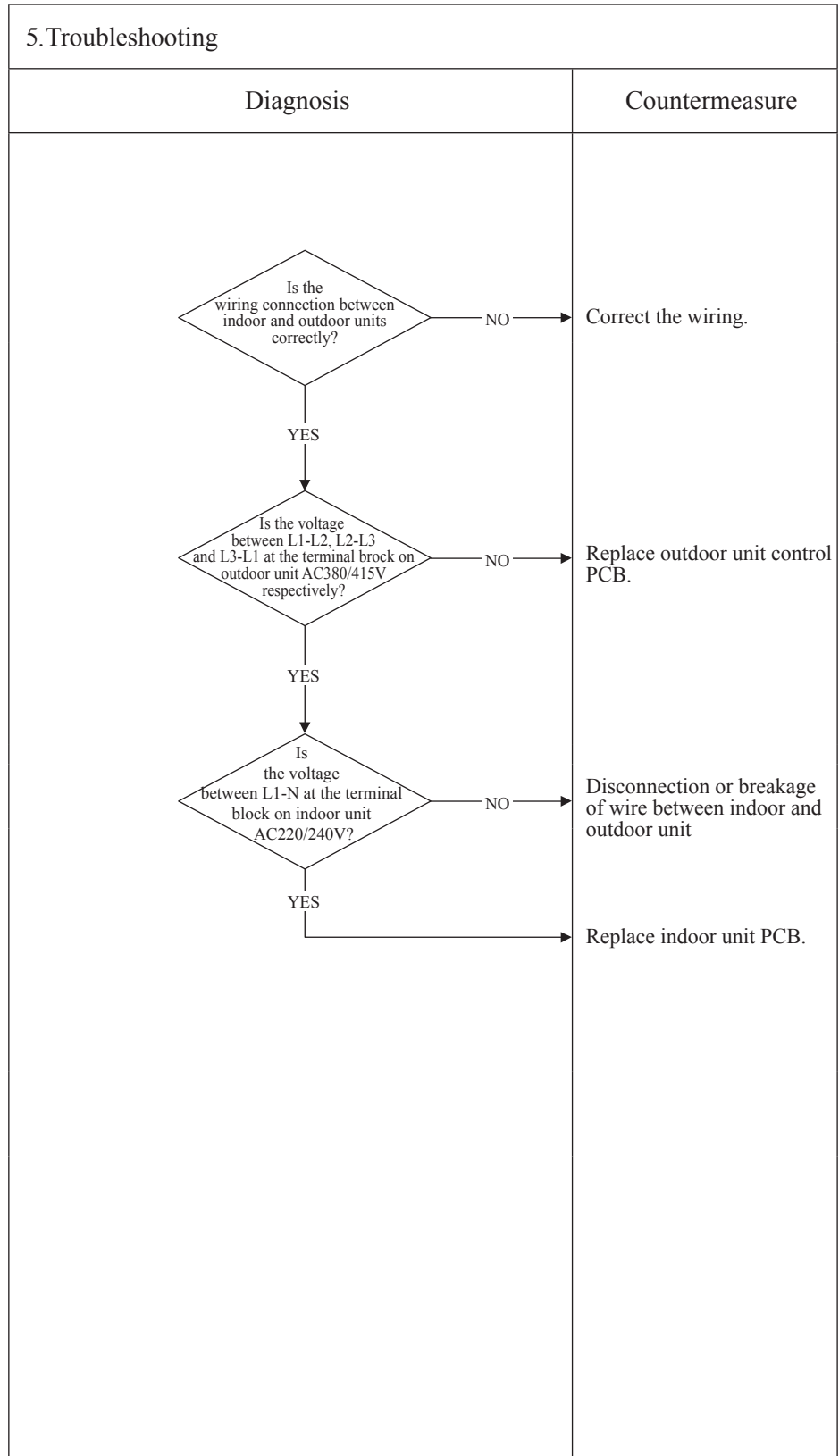

Note:

Error code Remote control: E31 7-segment display: E31	LED	Green	Red	Content Duplicated outdoor unit address No.
	Indoor	Keeps flashing	Stays Off	
	Outdoor	Keeps flashing	1 time flash	

1. Applicable model

Outdoor unit

2. Error detection method

When the microcomputer of outdoor unit control PCB recognizes the duplicated address No. by scanning all addresses of outdoor units in the same Superlink system.

3. Condition of error displayed

When duplicated outdoor unit address No. exists in the same Superlink system.

4. Presumable cause

- Mistake in the address setting of outdoor units
- More than 129 indoor units connected
 [Maximum number can be set by address switch is 128 units]
- No setting of Master/Slave setting switch for combination use

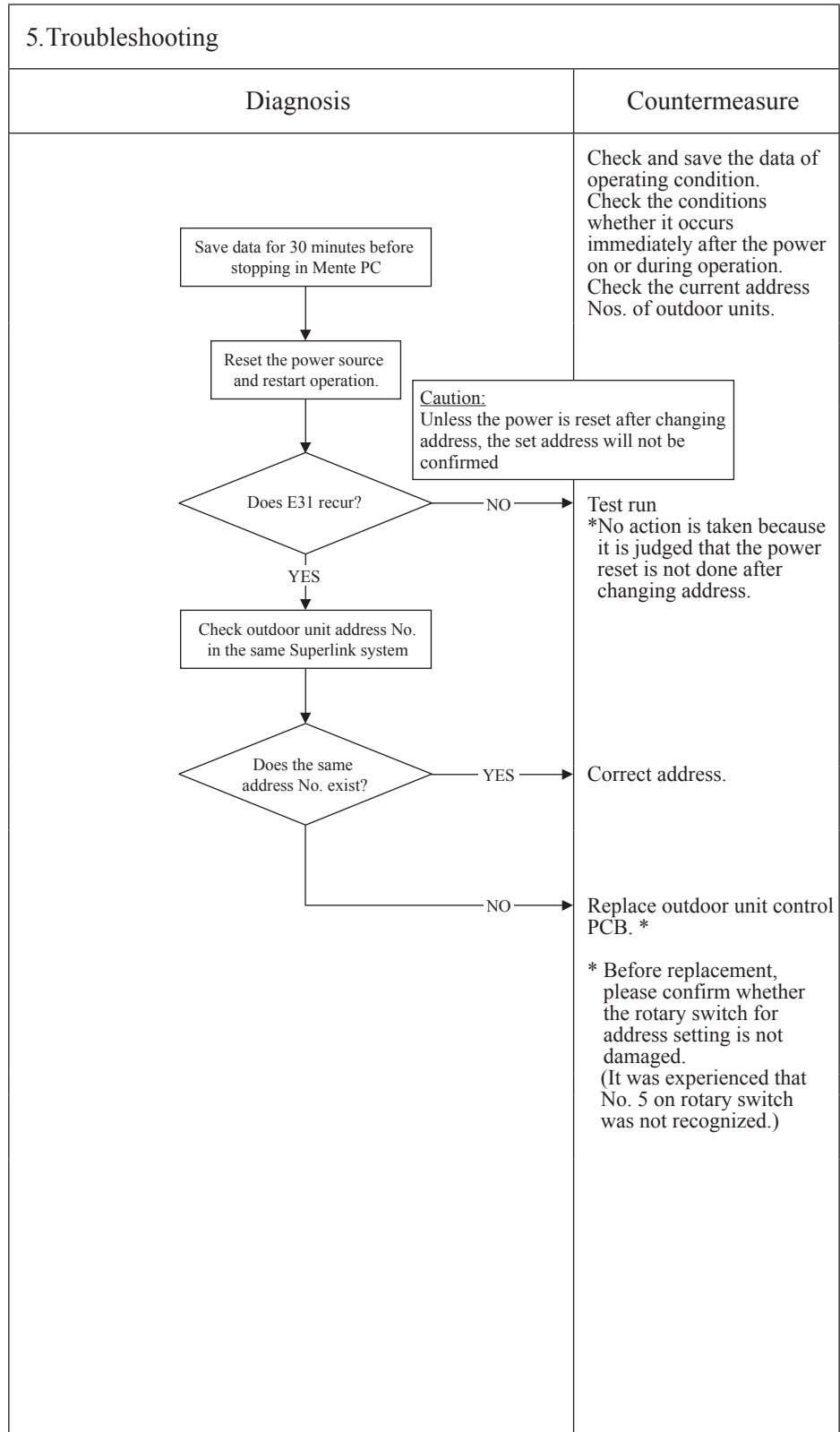

Note: After taken above measure, reset the power and confirm no error is displayed occurs
 Unless the power is reset after changing address, the set address will not be confirmed
 In case of combination use, set the same address to both master and slave units. Distinction of master or slave unit is done by setting SW4-7. (Refer to the instruction manual and technical manual for details)

Error code Remote control: E32 7-segment display: E32	LED	Green	Red	Content <h2 style="text-align: center;">Open L3 Phase on power source at primary side</h2>
	Indoor	Keeps flashing	Stays Off	
	Outdoor	Keeps flashing	1 time flash	

1. Applicable model

Outdoor unit

2. Error detection method

By Checking the power source voltage at primary side of the outdoor unit control PCB (Check only L3 phase)

3. Condition of error displayed

When the power source voltage between L1-L3 or L2-L3 becomes 0V and/or the current of L3 decrease to 0A

4. Presumable cause

- Anomalous power source at primary side
- Outdoor unit control PCB anomaly.

5. Troubleshooting

Diagnosis	Countermeasure
<pre> graph TD A[Save data for 30 minutes before stopping in Mente PC] --> B{Is the power source voltage (between phases) at the primary side OK?} B -- NO --> C[Propose an improvement to the customer.] B -- YES --> D[Reset the power source and restart operation.] D --> E{Does E32 recur?} E -- YES --> F[Replace outdoor unit control PCB.] E -- NO --> G[Wait and see without taking any action.] </pre>	<p>Check and save the data of operating condition. Check the conditions whether it occurs immediately after the power on or during operation or stopping. (It will be useful to persuade the customer why an improvement of power source is required by showing these data.)</p> <p>Propose an improvement to the customer.</p> <p>Check it, as much as possible, under the operating conditions for 30 minutes before error occurred.</p> <p>Replace outdoor unit control PCB.</p> <p>Wait and see without taking any action.</p>

Note:

Error code Remote control: E36 7-segment display: E36-1	LED	Green	Red	Content Discharge pipe temperature error (Tho-D1)
	Indoor	Keeps flashing	Stays Off	
	Outdoor	Keeps flashing	1 time flash	

1.Applicable model

Outdoor unit

2. Error detection method

When anomalously high temperature is detected by the discharge pipe temperature sensor (Tho-D1)

3. Condition of error displayed

When 130°C or higher is detected by the discharge temperature sensor, the compressor stops. After 3 minutes delay, the compressor starts again automatically, but if this anomaly occurs 2 times within 60 minutes after the initial detection, or 130°C or higher is detected continuously for 60 minutes.

- 4. Presumable cause**
- Discharge pipe temperature anomaly
 - SV1 (liquid refrigerant by-pass valve) anomaly
 - Beakage of coil
 - Faulty main body.
 - Outdoor unit control PCB anomaly
 - Insufficient amount of refrigerant
 - Insufficient air flow volume
 - Short-circuit of air flow

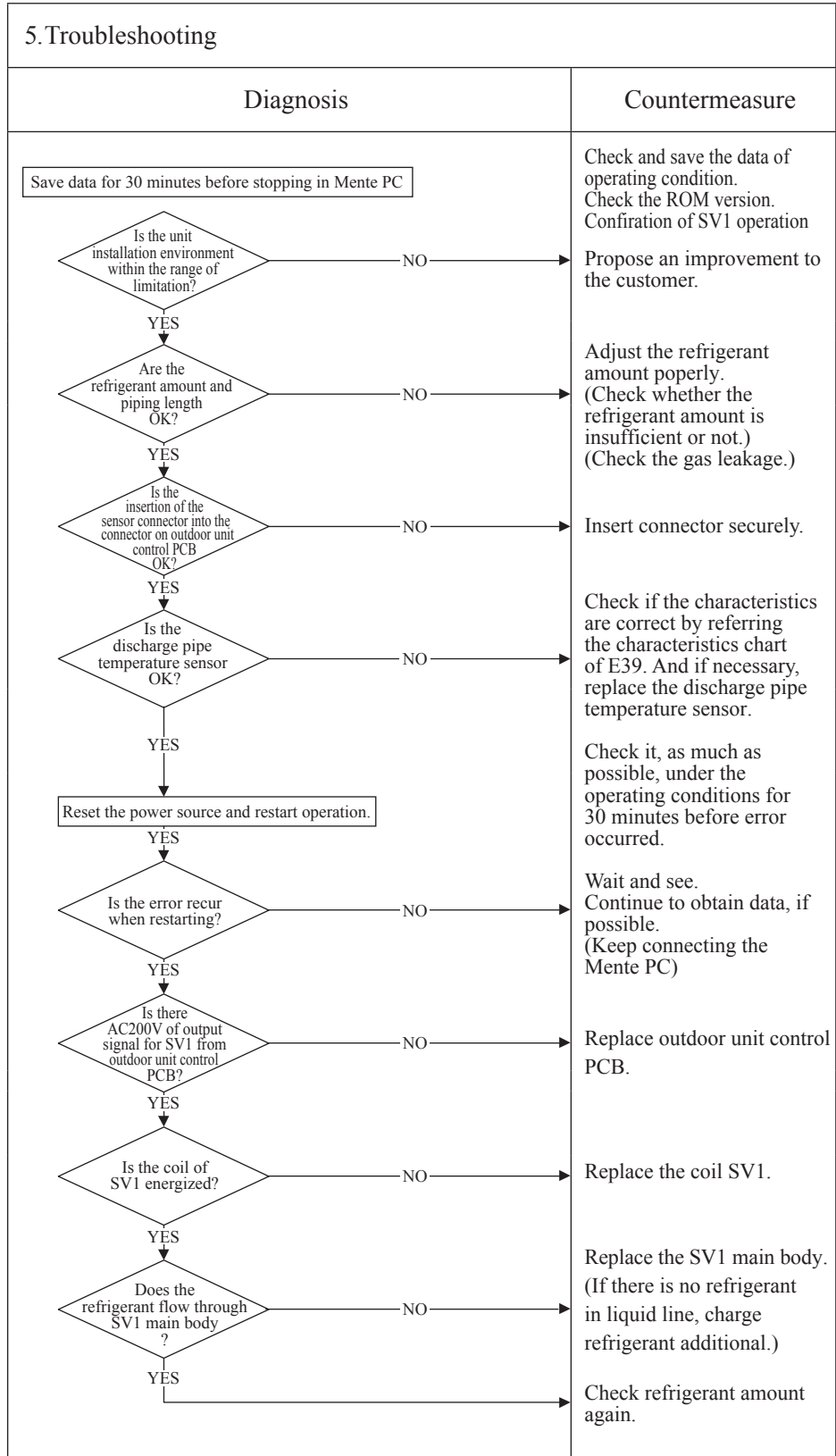

Note:

Error code Remote control: E36 7-segment display: E36-3	LED	Green	Red	Content <h2 style="text-align: center;">Liquid flooding anomal</h2>
	Indoor	Keeps flashing	Stays Off	
	Outdoor	Keeps flashing	3 times flash	

1. Applicable model
Outdoor units
2. Error detection method
When 5°C or lower of the under-dome temperature superheat is detected for 15 minutes continuously or for 30 minutes continuously.
3. Condition of error displayed
When above anomaly is detected 3 times within 90 minutes.
4. Presumable cause
<ul style="list-style-type: none"> • Unmatching of refrigerant piping and/or signal wiring • Overcharging of refrigerant • Anomalous control of superheat • Anomalous circuit of liquid refrigerant by-pass • Anomalous refrigerant circuit of subcool coil • Under-dome temperature (Tho-D1) anomaly

5. Troubleshooting	
Diagnosis	Countermeasure
<div style="border: 1px solid black; padding: 5px; margin-bottom: 10px;">Save data for 30 minutes before stopping in Mente PC</div>	<p>Check and save the data of operating condition. Check the ROM version. Confirmation of SV1 operation</p> <p>Correct the connection of refrigerant piping and/or signal wiring properly.</p> <p>Adjust refrigerant amount properly.</p> <p>Replace SV1. Replace the coil of SV1.</p> <p>Replace EEVSC. Check the coil of EEVSC → Replace the coil of EEVSC. Replace Tho-H. Replace PSL.</p> <p>Replace indoor EEV. Check the coil of EEV → Replace the coil of EEV. Check the installed position of Thi-R1, R2, R3 → Replace Thi-R, if necessary. Check the air filter. Check the connection of indoor fan motor connector → Replace indoor fan motor. * By checking Thi-R1, R2, R3 from indoor unit operation data of Mente PC, specify the indoor unit which tends to be liquid flooding. (Thi-R3=Thi-R2 shows the probability of liquid flooding)</p> <p>Replace EEVH1. Check the coil of EEVH1 → Replace the coil of EEVH1. Check the installed position of Tho-R1, R2, R3 → Replace Tho-R, if necessary. Clean the fin of outdoor heat exchanger. Check the connection of outdoor fan motor connector → Replace outdoor fan motor.</p> <p>Replace Tho-C1.</p> <p>Correct the data with Mente PC and ask our consultation.</p>

Note: If the error does not recur, connect the Mente PC and continue to collect data.

Error code Remote control: E37 7-segment display: E37-1, 2, 5, 6*1	LED	Green	Red	Content Outdoor unit heat exchanger temperature sensor (Tho-R) and subcooling coil temperature sensor (Tho-SC,-H) anomaly
	Indoor	Keeps flashing	Stays Off	
	Outdoor	Keeps flashing	*1	

*1 E37-1: one time flash (Tho-R1), E37-2: 2 time flash (Tho-R2), E37-5: 5 time flash (Tho-SC), E37-6: 6 time flash (Tho-H)

1. Applicable model Outdoor unit	5. Troubleshooting	
2. Error detection method Detection of anomalously low temperature (resistance) of Tho-R or Tho-SC or Tho-H	Diagnosis	Countermeasure
3. Condition of error displayed <ul style="list-style-type: none"> If -50°C or lower is detected for 5 seconds continuously within 2 minutes to 2 minutes 20 seconds after the compressor ON, the compressor stops. And after 3 minutes delay, the compressor starts again automatically, but if this anomalous temperature is detected 3 times within 40 minutes after the initial detection. If -50°C or lower is detected for 5 seconds continuously within 20 seconds after power ON 	<div style="border: 1px solid black; padding: 5px; margin-bottom: 10px;">Save data for 30 minutes before stopping in Mente PC</div> <p>*2 Check several times to prove any poor connection</p>	Check and save the data of operating conditions. Check the conditions whether it occurs immediately after the power on or during operation or stopping. Check the sensed value. Compare the temperature on Mente PC with actual measured value. Insert the connector securely. Replace sensor . (Tho-SC, Tho-H, Tho-R) Replace outdoor unit control PCB.
4. Presumable cause <ul style="list-style-type: none"> Broken sensor harness or the internal wire of sensing section (Check the molded section as well) Disconnection of sensor harness connection (connector) Outdoor unit control PCB anomaly 	Outdoor heat exchanger temperature sensor (Tho-R1, R2, R5, R6) Sub-cooling coil sensor (Tho-SC, Tho-H) Temperature-resistance characteristics	

Note:

Error code Remote control: E38 7-segment display: E38	LED	Green	Red	Content Outdoor air temperature sensor anomaly (Tho-A)
	Indoor	Keeps flashing	Stays Off	
	Outdoor	Keeps flashing	1 time flash	

1. Applicable model

Outdoor unit

2. Error detection method

Detection of anomalously low temperature (resistance) of Tho-A

3. Condition of error displayed

- If -30°C or lower is detected for 5 seconds continuously within 2 minutes to 2 minutes 20 seconds after the compressor ON, the compressor stops. And after 3 minutes delay, the compressor starts again automatically, but if this anomalous temperature is detected 3 times within 40 minutes after the initial detection.
- If -30°C or lower is detected for 5 seconds continuously within 20 seconds after power ON.

4. Presumable cause

- Broken sensor harness or the internal wire of sensing section (Check the molded section as well)
- Disconnection of sensor harness connection (connector)
- Outdoor unit control PCB anomaly

5. Troubleshooting

Diagnosis	Countermeasure
<div style="border: 1px solid black; padding: 5px; margin-bottom: 10px;">Save data for 30 minutes before stopping in Mente PC</div> <pre> graph TD A{Is the connector of sensor connected properly?} -- NO --> B[Insert the connector securely.] A -- YES --> C{Are the characteristics of sensor OK?*1} C -- NO --> D[Replace sensor (Tho-A).] C -- YES --> E[Replace outdoor unit control PCB.] </pre> <p>*1 Check several times to prove any poor connection</p>	<p>Check and save the data of operating condition. Check the conditions whether it occurs immediately after the power on or during operation or stopping. Check the sensed value. Compare the temperature on Mente PC with actual measured value.</p> <p>Insert the connector securely.</p> <p>Replace sensor (Tho-A).</p> <p>Replace outdoor unit control PCB.</p>

Temperature-resistance characteristics of Outdoor air temperature sensor (Tho-A)

Temperature (°C)	Temperature sensor resistance (kΩ)
-20	100
-10	70
0	45
10	25
20	15
30	10
40	7
50	5

Note:

Error code Remote control: E39 7-segment display: E39-1	LED	Green	Red	Content Discharge pipe temperature sensor anomaly (Tho-D1)
	Indoor	Keeps flashing	Stays Off	
	Outdoor	Keeps flashing	1 time flash	

1. Applicable model

Outdoor unit

2. Error detection method

Detection of anomalously low temperature (resistance) of Tho-D1

3. Condition of error displayed

- If 3°C or lower is detected for 5 seconds continuously within 10 minutes to 10 minutes 20 seconds after the compressor ON, the compressor stops. And after 3 minutes delay, the compressor starts again automatically, but if this anomalous temperature is detected 3 times within 40 minutes after the initial detection.

4. Presumable cause

- Broken sensor harness or the internal wire of sensing section (Check the molded section as well)
- Disconnection of sensor harness connection (connector)
- Outdoor unit control PCB anomaly

5. Troubleshooting

Diagnosis	Countermeasure
<div style="border: 1px solid black; padding: 5px; margin-bottom: 10px;">Save data for 30 minutes before stopping in Mente PC</div> <pre> graph TD Q1{Is the connector of sensor connected properly?} -- NO --> C1[Insert the connector securely.] Q1 -- YES --> Q2{Are the characteristics of sensor OK? *3} Q2 -- NO --> C2[Replace sensor (Tho-D1).] Q2 -- YES --> C3[Replace outdoor unit control PCB.] </pre> <p>*3 Check several times to prove any poor connection</p>	<p>Check and save the data of operating condition. Check the conditions whether it occurs immediately after the power on or during operation or stopping. Check the sensed value. Compare the temperature on Mente PC with actual measured value.</p>

Temperature-resistance characteristics of discharge pipe temperature sensor (Tho-D1)

Temperature (°C)	Temperature sensor resistance (kΩ)
0	180
20	100
40	60
60	40
80	30
100	25
120	22
140	21
160	20

Note:

Error code Remote control: E40 7-segment display: E40	LED	Green	Red	Content High pressure anomaly (63H1-1activated)
	Indoor	Keeps flashing	Stays Off	
	Outdoor	Keeps flashing	1 time flash	

1.Applicable model
Outdoor unit
2. Error detection method
When high pressure switch 63H1-1 is activated
3. Condition of error displayed
<ul style="list-style-type: none"> • If high pressure exceeds 4.15MPa • If 63H1-1 is activated 5 times within 60 minutes • If 63H1-1 is activated for 60 minutes continuously
4. Presumable cause
<ul style="list-style-type: none"> • Short-circuit of airflow at condenser side of heat exchanger/Disturbance of airflow/Clogging filter/Fan motor anomaly • Disconnection of high pressure switch connector • Breakage of high pressure switch harness • Closed service valves • High pressure sensor anomaly • High pressure switch anomaly

5. Troubleshooting	
Diagnosis	Countermeasure
<div style="border: 1px solid black; padding: 5px; width: fit-content; margin: 0 auto;">Save data for 30 minutes before stopping in Mente PC</div> <pre> graph TD Start([Start]) --> D1{Was 63H1 activated at 4.15MPa or higher?} D1 -- NO --> D2{Does the sensed value of the high pressure sensor show 4.15MPa? (Normal?)} D2 -- YES --> D3{Are the 63H1-1 OK? Are the connector and/or harnesse OK?} D3 -- YES --> C1[Check and save the data of operating condition. Check the sensed value of high pressure sensor when the 63H1-1 is activated. Check whether the high pressure switch is activated at the sensed value of high pressure sensor.] D3 -- NO --> C2[High pressure sensor anomaly is suspicious. Check high pressure sensor itself according to the troubleshooting procedure of E54, after restarting operation. (If the high pressure sensor [PSH] fails, replace it)] D1 -- YES --> D4{Are the service valves fully open?} D4 -- NO --> C3[Open operation valve.] D4 -- YES --> R1[Connect a pressure gauge and restart operation.] R1 --> D5{Is it stop at 4.15MPa of gauge pressure?} D5 -- NO --> C4[Replace outdoor control PCB.] D5 -- YES --> D6{Is there any clogging in the refrigerant circuit?} D6 -- YES --> C5[Remove clogs.] D6 -- NO --> C6[Check items (condenser side): Filter clogging, Air flow volume (Fan motor), Short-circuit of air flow] </pre>	
<p>Note: If the error does not recur, connect the Mente PC and continue to collect data.</p>	

Error code Remote control: E41(E51) 7-segment display: E41(E51)-1	LED	Green	Red	Content <h2 style="text-align: center;">Power transistor overheat</h2>
	Indoor	Keeps flashing	Stays Off	
	Outdoor	Keeps flashing	1 time flash	

1. Applicable model

Outdoor unit

2. Error detection method

When anomalously high temperature is detected by power transistor temperature sensor (Tho-P1)

3. Condition of error displayed

Anomalously high temperature of power transistor is detected 5 times within 60 minutes (E41). Or it is detected for 15 minutes continuously (E51)

- 4. Presumable cause**
- Power transistor anomaly
 - Power transistor temperature sensor anomaly
 - Improperly fixing of power transistor to radiator fin
 - Inverter PCB anomaly
 - Outdoor fan motor anomaly
 - Anomalous cooling fan motor for inverter
 - Inadequate installation space of outdoor unit

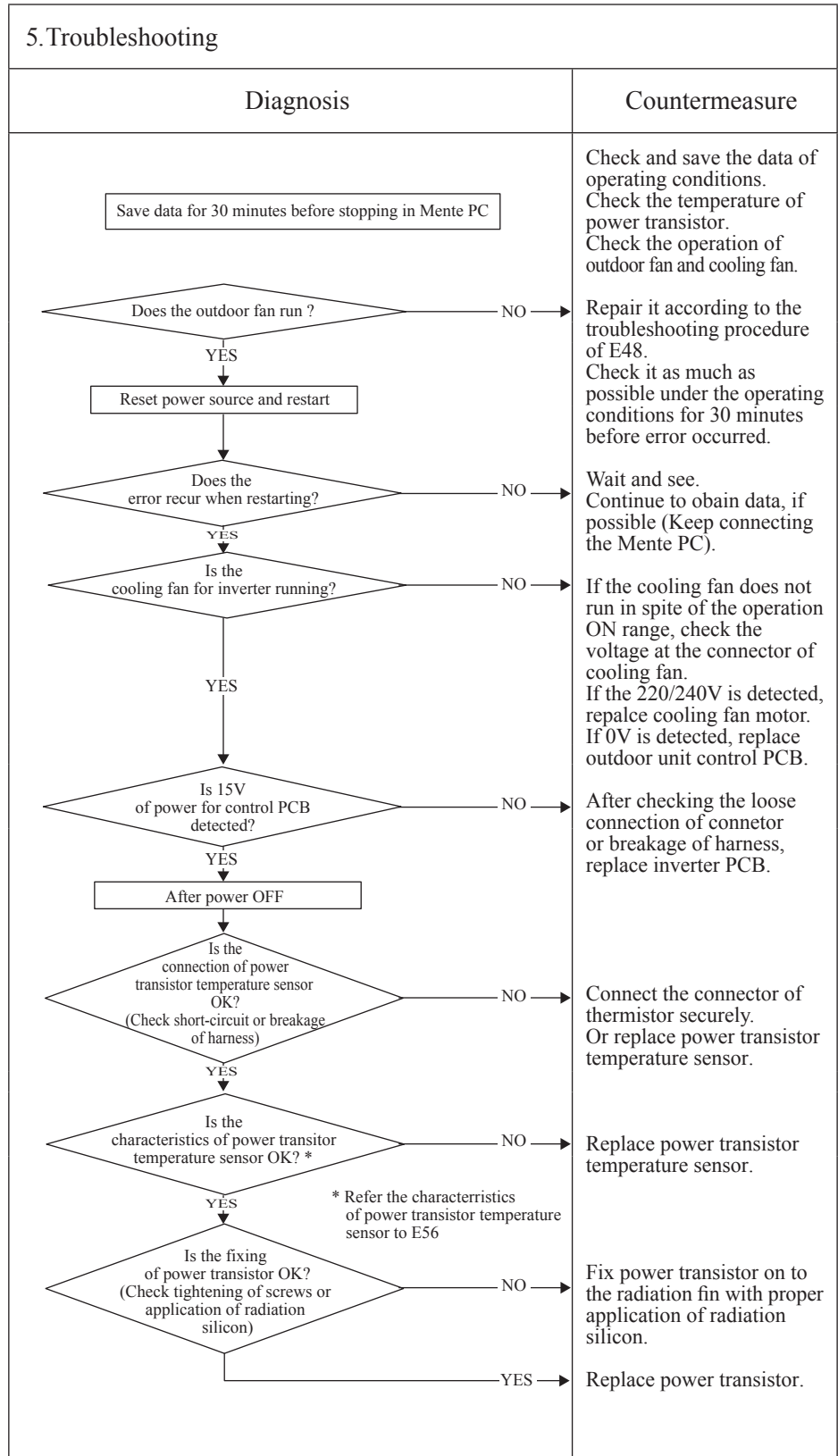

Note: The operating conditions of cooling fan for inverter is shown in the right figure
 If the error does not recur, connect the Mente PC and continue to collect data.

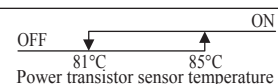

Error code Remote control: E42 7-segment display: E42-1	LED	Green	Red	Content <h2 style="text-align: center;">Current cut (CM1)</h2>
	Indoor	Keeps flashing	Stays Off	
	Outdoor	Keeps flashing	1 time flash	

1. Applicable model
Outdoor unit
2. Error detection method
When anomalously high output current of inverter is detected by the current sensormounted in the power transistor
3. Condition of error displayed
When 88A or higher output current of inverter is detected 4 times within 15 minutes.
4. Presumable cause
<ul style="list-style-type: none"> • Compressor anomaly • Leakage of refrigerant • Power transistor module anomaly • Anomalous power source for inverter PCB • Outdoor fan motor anomaly

5. Troubleshooting	
Diagnosis	Countermeasure
<div style="border: 1px solid black; padding: 5px; width: fit-content; margin: 0 auto;">Save data for 30 minutes before stopping in Mente PC</div> <pre> graph TD A{Is the coil resistance and insulation (megger check) of compressor motor OK?} -- NO --> B[Replace compressor. Check the capillary tube and stariner of oil separator. If necessary, replace the capillary tube and strainer as well.] A -- YES --> C{Does the outdoor fan run?} C -- NO --> D[Repair it according to the troubleshooting of E48.] C -- YES --> E{Is 15V of power for control PCB detected? Is the outdoor fan motor OK? (Refer the checking method of 15V in page63)} E -- NO --> F[Replace inverter PCB or outdoor fan motor.] E -- YES --> G[Reset power source and restart] G --> H{Does E42 recur?} H -- NO --> I[Wait and see. Continue to obain data, if possible (Keep connecting the Mente PC).] H -- YES --> J{Do you have inverter checker for judging whether inverter PCB is OK or not?} J -- YES --> K{Is the checked result by inverter checker OK?} K -- NO --> L[Replace power transistor module. Replace inverter PCB.] K -- YES --> M[After power OFF, Remove the 1-3 layers of control box] J -- NO --> M M --> N{Is the checked result by measuring the resistance between each terminal of power transistor module OK? (Are there any short-circuit?)} N -- NO --> O[Replace power transistor module. Refer Page 63. (Remove the power cable from compressor and check the resistance between P-U, P-V, P-W, N-U, N-V, N-W respectively.)] N -- YES --> P[Replace inverter PCB.] </pre>	

Note: In case that there is no the insulation resistance anomaly, the compressor anomaly could be considered. If this anomaly occurs after replacement of power transistor module and/or inverter PCB, try to replace compressor as well. If the error does not recur, connect the Mente PC and continue to collect data

Error code Remote control: E43 7-segment display: E43-1, 2 *1	LED	Green	Red	Content Excessive number of indoor units connected, excessive total capacity of connection
	Indoor	Keeps flashing	Stays Off	
	Outdoor	Keeps flashing	*1	

*1 E43-1:1 time flash (Excessive number of indoor units connected), E43-2:2 time flash (Excessive capacity of indoor units connection)

1. Applicable model Outdoor unit	5. Troubleshooting		
2. Error detection method When the number of connected indoor units exceeds the limitation. When the total capacity of connected indoor units exceeds the limitation.	Diagnosis		Countermeasure
3. Condition of error displayed <ul style="list-style-type: none"> Excessive number of connected indoor units Excessive total capacity of connected indoor units The total capacity of connected indoor units exceeds the limitation 	<div style="border: 1px solid black; padding: 5px; margin-bottom: 10px; text-align: center;">Save data for 30 minutes before stopping in Mente PC</div> <div style="border: 1px solid black; padding: 5px; margin-bottom: 10px;"> Reset the power. </div> <div style="border: 1px solid black; padding: 5px; margin-bottom: 10px;"> Does E43 recur? </div> <div style="border: 1px solid black; padding: 5px; margin-bottom: 10px;"> Does the number of indoor units connected and/or total capacity of connected indoor units exceed the limitation? </div> <div style="border: 1px solid black; padding: 5px; margin-bottom: 10px;"> Is there any indoor units which is not expected to exist in that signal line? </div> <div style="border: 1px solid black; padding: 5px; margin-bottom: 10px;"> Check the number of connected indoor units by the code No.C50 of 7-segment display or Mente PC with reference to the utility drawing (check not only one system, but also other systems) </div> <div style="border: 1px solid black; padding: 5px; margin-bottom: 10px;"> Check the resistance between A and B of signal line as well. </div> <div style="border: 1px solid black; padding: 5px;"> Thoroughly checking of the addresses of indoor/outdoor units by means of • Outdoor unit: Mente PC, 7-segment display and rotary switch (SW1, SW2) • Indoor unit: Remote control and rotary switch (SW1, 2, 3, 4) * Recommend to use means other than the rotary switch which could be faulty </div>		Check and save the data of operating condition. Test run. No action is taken because it is judged that the power reset was not done after changing address. Check indoor unit addresses and correct it. In case that total capacity of connected indoor units exceeds the limitation if tentative operation is required, turn ON the DIP switch SW5-4 on the outdoor unit control PCB. (However since this tentative solution could cause trouble, be sure to correct it as soon as possible.) Signal wire may be connected to other outdoor unit system. →Correct the signal wire. Correct addresses. (Either one of addresses is wrong.) If the address corrected by rotary switch is still wrong, replace control PCB (rotary switch anomaly). * Before replacement, please confirm whether the rotary switch for address setting is not damaged. (It was experienced that No. 5 on rotary switch was not recognized.)
4. Presumable cause <ul style="list-style-type: none"> Mistake in setting of indoor/outdoor unit addresses Mistake in signal wire connection 			

Note: After completing the above procedure, reset the power and confirm that the error display does not recur. Unless the power is reset for both indoor unit and outdoor unit, the set addresses will not be confirmed.

Error code Remote control: E45 7-segment display: E45-1	LED	Green	Red	Content Communication error between inverter PCB and outdoor unit control PCB
	Indoor	Keeps flashing	Stays Off	
	Outdoor	Keeps flashing	1 time flash	

1. Applicable model
Outdoor unit

2. Error detection method
When the communication between inverter PCB and outdoor unit control PCB is not established.

3. Condition of error displayed
Same as above

- 4. Presumable cause**
- Signal wire anomaly
 - Outdoor unit control PCB anomaly
 - Inverter PCB (INV1) anomaly
 - Rush current prevention resistor anomaly

5. Troubleshooting

Diagnosis	Countermeasure
<p>Save data for 30 minutes before stopping in Mente PC</p> <p>Is 15V of power for control PCB detected? Is the outdoor fan motor OK? (Refer the checking method of 15V in page 63)</p> <p>NO →</p> <p>YES →</p> <p>Reset power source and restart</p> <p>Does E45 recur?</p> <p>NO →</p> <p>YES →</p> <p>Turn off the power. IS the harness and/or connector between inverter PCB and outdoor unit control PCB OK ?</p> <p>NO →</p> <p>YES →</p> <p>Is the rush current prevention resistor broken?</p> <p>YES →</p> <p>NO →</p> <p>Is the harness and/or connector between inverter PCB and diode module OK?</p> <p>NO →</p> <p>YES →</p> <p>Is the setting of switches on the inverter PCB OK? *</p> <p>NO →</p> <p>YES →</p>	<p>Check and save the data of operating conditions.</p> <p>Replace inverter PCB or outdoor fan motor.</p> <p>Check it as much as possible under the operating conditions for 30 minutes before error occurred.</p> <p>Wait and see. Continue to obtain data, if possible (Keep connecting the Mente PC).</p> <p>Check whether the harness is broken? Check whether the connector is loose? → If there is problem, correct it.</p> <p>Disconnect the harness from the resistor and measure the resistance. If broken, replace the resistor. In such case check the harness between diode module and inverter PCB as well.</p> <p>Check whether the harness is broken? Check whether the connector is loose? → If there is problem, correct it.</p> <p>Correct the setting of switches on the inverter PCB.</p> <p>Replace outdoor unit control PCB.</p>

* Switch setting of inverter PCB

SW1-1	OFF
SW1-2	OFF
SW1-3	OFF
SW1-4	OFF
JSW1-1	ON
JSW1-2	OFF
JSW1-3	OFF
JSW1-4	OFF

Note: If the error does not recur, connect the Mente PC and continue to collect data.

Error code Remote control: E46 7-segment display: E46	LED	Green	Red	Content Mixed address setting methods coexistent in same network.
	Indoor	Keeps flashing	Stays Off	
	Outdoor	Keeps flashing	Stays Off	

1. Applicable model

Outdoor unit

2. Error detection method

If the signal line of a outdoor unit system applied automatic address setting is connected to other outdoor unit system (Detected at indoor unit side)

3. Condition of error displayed

Same as above

4. Presumable cause

- Mistake in the address setting
- Mistake in the connection of signal wire

5. Troubleshooting

Diagnosis	Countermeasure									
<p>Save data for 30 minutes before stopping in Mente PC</p> <p>Reset power source and restart</p> <p>Does E46 recur?</p> <p>NO</p> <p>YES</p> <p>Is't the signal line of a outdoor unit system applying automatic address setting connected to other outdoor unit system?</p> <p>YES</p> <p>NO</p> <p>If signal line is connected to more than 2 outdoor unit systems, address setting should be done by manually.</p> <p>Is E46 still displayed?</p> <p>NO</p> <p>YES</p> <p>Turn ON the power of each outdoor unit one by one and search the outdoor unit that can start up with automatic address setting</p> <p><Reference> Error display at mixed address setting</p> <table border="1"> <tr> <td></td> <td>Auto</td> <td>Manual</td> </tr> <tr> <td>Auto address setting</td> <td>E31</td> <td>E46</td> </tr> <tr> <td>Manual address setting</td> <td>E46</td> <td>Normal</td> </tr> </table>		Auto	Manual	Auto address setting	E31	E46	Manual address setting	E46	Normal	<p>Check and save the data of operating conditions. Check the address setting method of faulty network whether it is automatic setting or manual setting.</p> <p>Caution: Unless the power is reset after changing address, the set address will not be confirmed.</p> <p>Test run. * No action is taken because it is judged that the power rest is not done after changing address.</p> <p>Correct signal line. *In case of automatic address setting, signal line cannot be connected to other outdoor unit system.</p> <p>Test run</p> <p>Replace outdoor unit control PCB*. (Rotary switch anomaly)</p> <p>* Before replacement, please confirm whethe the rotary switch for address setting is not damaged. (It was experienced that No.5 on rotary switch was not recognized.)</p>
	Auto	Manual								
Auto address setting	E31	E46								
Manual address setting	E46	Normal								

Note: After completing the above procedure, reset the power and confirm that the error display does not recur. Unless the power is reset for both indoor unit and outdoor unit, the set addresses will not be confirmed

Error code Remote control: E48 7-segment display: E48-1, 2 *1	LED	Green	Red	Content <h2 style="text-align: center;">Outdoor unit DC fan motor anomaly</h2>
	Indoor	Keeps flashing	Stays Off	
	Outdoor	Keeps flashing	*1	

*1 E48-1: 1 time flash (FMO1), E48-2 : 2 time flash (FMO2)

1. Applicable model	5. Troubleshooting (Inspect also the fan motor 2 even if it is E48-1.) (Inspect also the fan motor 1 even if it is E48-2.)		
Outdoor unit	Diagnosis	Countermeasure	
2. Error detection method	<div style="border: 1px solid black; padding: 5px; margin-bottom: 10px;">Save data for 30 minutes before stopping in Mente PC</div> <div style="display: flex; justify-content: space-between;"> <div style="width: 60%;"> <p style="text-align: center;">Does the fan rotate smoothly when turned by hand?</p> <p style="text-align: center;">↓ YES</p> <p style="text-align: center;">Is 15V of power for control PCB detected? Is the outdoor fan motor OK? (Refer the checking method of 15V in page 63)</p> <p style="text-align: center;">↓ YES</p> <div style="border: 1px solid black; padding: 5px; margin-bottom: 10px; text-align: center;">Reset power source and restart</div> <p style="text-align: center;">Is E48 restored at 10 seconds after compressor starting?</p> <p style="text-align: center;">↓ YES</p> <div style="border: 1px solid black; padding: 5px; margin-bottom: 10px; text-align: center;">Turn the power source OFF</div> <div style="border: 1px solid black; padding: 5px; margin-bottom: 10px; text-align: center;">Interchange the connectors of fan motor harnesses at the connectors on outdoor unit control PCB side</div> <div style="border: 1px solid black; padding: 5px; margin-bottom: 10px; text-align: center;">Start operation again</div> <p style="text-align: center;">Is the fan motor failed to start up switched?</p> </div> <div style="width: 35%;"> <p style="text-align: center;">NO →</p> <p style="text-align: center;">NO →</p> <p style="text-align: center;">NO →</p> <p style="text-align: center;">NO →</p> <p style="text-align: center;">YES →</p> </div> </div>		
<ul style="list-style-type: none"> • If 400min⁻¹ or lower of the fan rotation command and the state of overcurrent are detected for 10 times continuously • If 100min⁻¹ of the actual fan rotation speed is detected for 30 seconds (Fan motor is locked) 	<p>Check and save the data of operating conditions.</p> <p>Replace fan motor.</p> <p>Replace inverter PCB or fan motor.</p> <p>Check it as much as possible under the operating conditions for 30 minutes before error occurred.</p> <p>Wait and see. Continue to obtain data, if possible. (Keep connecting the Mente PC)</p> <p>Replace fan motor.</p> <p>Replace outdoor unit control PCB.</p>		
3. Condition of error displayed	Same as above		
4. Presumable cause	<ul style="list-style-type: none"> • Breakage of harness or loose connection of connector • Outdoor fan motor anomaly • Inverter PCB anomaly • Outdoor unit control PCB anomaly 		

Note: If the error does not recur, connect the Mente PC and continue to collect data.

Error code Remote control: E49 7-segment display: E49	LED	Green	Red	Content <h2 style="text-align: center;">Low pressure anomaly</h2>
	Indoor	Keeps flashing	Stays Off	
	Outdoor	Keeps flashing	1 time flash	

1. Applicable model

Outdoor unit

2. Error detection method

Detection of anomalously low pressure

3. Condition of error displayed

- At start up after power on:
When the low pressure sensor detects lower than 0.003MPa for 60 seconds continuously. And if this anomaly occurs 2 times.
- During operation:
When the low pressure sensor detects 0.134MPa or lower for 30 seconds continuously. And if this anomaly occurs 5 times within 60 minutes

4. Presumable cause

- Low pressure sensor (PSL) anomaly
- Service valves closed
- EEV anomaly (EEV closed)
- Insufficient refrigerant amount
- Clogging at EEV or strainer

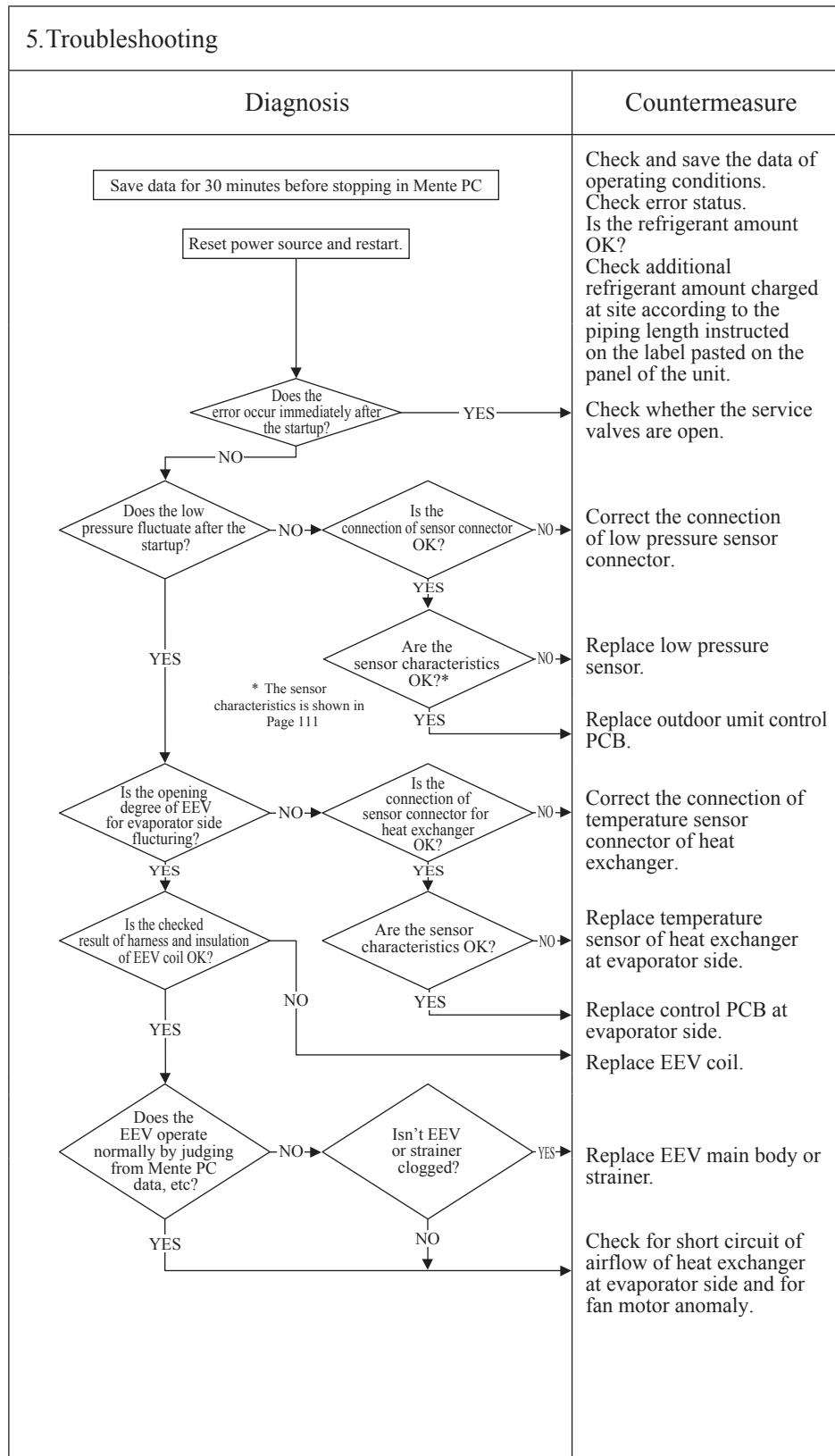

Note: Check whether the indoor unit is connected to other outdoor superlink network.
If the error does not recur, connect the Mente PC and continue to collect data.

Error code Remote control: E53/E55 7-segment display: E53/E55-1	LED	Green	Red	Content Suction pipe temperature sensor anomaly (Tho-S), Under-dome temperature sensor anomaly (Tho-C1)
	Indoor	Keeps flashing	Stays Off	
	Outdoor	Keeps flashing	1 time flash	

E53: Tho-S, E55-1: Tho-C1

1. Applicable model
Outdoor unit
2. Error detection method
Detection of anomalously low temperature (resistance) of Tho-S or Tho-C
3. Condition of error displayed
<ul style="list-style-type: none"> if -50°C or lower is detected for 5 seconds continuously within 2 minutes to 2 minutes 20 seconds after compressor ON, compressor stops. When the compressor is restarted automatically after 3-minutes delay, if this anomaly occurs 3 times within 40 minutes
4. Presumable cause
<ul style="list-style-type: none"> Broken thermistor harness or the internal wire of sensing section (Check the molded section as well) Disconnection of thermistor harness connection (connector) Outdoor unit control PCB anomaly

5. Troubleshooting

Diagnosis	Countermeasure
<div style="border: 1px solid black; padding: 5px; margin-bottom: 10px;">Save data for 30 minutes before stopping in Mente PC</div> <p style="text-align: center;">*1 Check several times to prove any poor connection</p> <div style="display: flex; justify-content: space-around; margin-top: 20px;"> <div style="text-align: center;"> <p>Temperature-resistance characteristics of suction pipe temperature sensor (Tho-S)</p> </div> <div style="text-align: center;"> <p>Temperature-resistance characteristics of under-dome temperature sensor (Tho-C1)</p> </div> </div>	<p>Check and save the data of operating conditions. Check the conditions whether it occurs immediately after the power on or during operation or stopping. Check the sensed value. Compare the temperature on Mente PC with actual measured value.</p> <p>Insert the connector securely</p> <p>Replace sensor (Tho-S or Tho-C1)</p> <p>Replace outdoor unit control PCB.</p>

Note:

Error code Remote control: E54 7-segment display: E54-1, 2 *1	LED	Green	Red	Content High pressure sensor anomaly (PSH) Low pressure sensor anomaly (PSL)
	Indoor	Keeps flashing	Stays Off	
	Outdoor	Keeps flashing	*1	

*1 E54-1: 1 time flash (PSL), E54-2 : 2 time flash (PSH)

1. Applicable model	Outdoor unit
2. Error detection method	Detection of anomalous pressure (voltage) of PSH or PSL [Operation range High pressure : 0-4.15MPa Low pressure : 0-1.7MPa]
3. Condition of error displayed	If anomalous sensor output voltage (0V or lower or 3.49V or higher) is detected for 5 seconds within 2 minutes to 2 minutes 20 seconds after the compressor ON
4. Presumable cause	<ul style="list-style-type: none"> • Broken sensor harness • Disconnection of sensor harness connection (connector) • Sensor (PSH, PSL) anomaly • Outdoor unit control PCB anomaly • Anomalous installation conditions • Insufficient air flow volume • Excessive or insufficient refrigerant amount

5. Troubleshooting																	
Diagnosis	Countermeasure																
<p>Save data for 30 minutes before stopping in Mente PC</p> <p>Check the data for 30 minutes before stopping</p> <p>Is anomalous pressure detected?</p> <p>NO → Reset the power and restart operation.</p> <p>YES → Is the connector of the sensor inserted properly to the connector on the outdoor control PCB?</p> <p>NO → Insert the connector securely and restart operation.</p> <p>YES → Reset the power and restart operation.</p> <p>E54 Does it recur?</p> <p>NO → Temporary malfunction by noise. Correct if the source of noise is specified.</p> <p>YES → Does the pressure converted from the sensor output voltage match the actual pressure measure by pressure gauge?</p> <p>NO → Replace sensor (PSH, PSL).</p> <p>YES → Replace outdoor unit control PCB.</p>																	
<div style="display: flex; justify-content: space-around;"> <div style="text-align: center;"> <p>High pressure sensor output characteristics</p> <table border="1"> <caption>High pressure sensor output characteristics</caption> <thead> <tr> <th>Pressure (MPa)</th> <th>Output voltage (V)</th> </tr> </thead> <tbody> <tr><td>0</td><td>0.5</td></tr> <tr><td>2.08</td><td>2.0</td></tr> <tr><td>4.15</td><td>3.5</td></tr> </tbody> </table> </div> <div style="text-align: center;"> <p>Low pressure sensor output characteristics</p> <table border="1"> <caption>Low pressure sensor output characteristics</caption> <thead> <tr> <th>Pressure (MPa)</th> <th>Output voltage (V)</th> </tr> </thead> <tbody> <tr><td>0</td><td>0.5</td></tr> <tr><td>0.85</td><td>2.0</td></tr> <tr><td>1.7</td><td>3.5</td></tr> </tbody> </table> </div> </div> <p>Sensor output Black (GND) – White; Output voltage (Black – Red; DC5V)</p>		Pressure (MPa)	Output voltage (V)	0	0.5	2.08	2.0	4.15	3.5	Pressure (MPa)	Output voltage (V)	0	0.5	0.85	2.0	1.7	3.5
Pressure (MPa)	Output voltage (V)																
0	0.5																
2.08	2.0																
4.15	3.5																
Pressure (MPa)	Output voltage (V)																
0	0.5																
0.85	2.0																
1.7	3.5																

Note:

Error code Remote controller: E56 7-segment display: E56-1	LED	Green	Red	Content Power transistor temperature sensor anomaly (Tho-P1)
	Indoor	Keeps flashing	Stays Off	
	Outdoor	Keeps flashing	1 time flash	

1. Applicable model

Outdoor unit

2. Error detection method

Detection of anomalously low temperature (resistance) of Tho-P1

3. Condition of error displayed

When the outdoor air temperature is above 0°C, if -10°C or lower is detected for 20 seconds continuously within 10 minutes to 10 minutes 30 seconds after compressor ON, compressor stops. When the compressor is restarted automatically after 3-minutes delay, if this anomaly occurs 3 times within 40 minutes

- 4. Presumable cause**
- Broken sensor harness or the internal wire of sensing section (Check the molded section as well)
 - Disconnection of sensor harness connection (connector)
 - Outdoor unit control PCB anomaly

5. Troubleshooting

Diagnosis	Countermeasure																		
<div style="border: 1px solid black; padding: 5px; margin-bottom: 10px;">Save data for 30 minutes before stopping in Mente PC</div> <pre> graph TD Q1{Is the connector of sensor connected properly OK?} Q2{Are the characteristics of sensor OK? *1} Q1 -- NO --> C1[Insert the connector securely.] Q1 -- YES --> Q2 Q2 -- NO --> C2[Replace power transistor temperature sensor (Tho-P1).] Q2 -- YES --> C3[Replace outdoor unit control PCB.] </pre> <p>*1 Check several times to prove any poor connection</p> <div style="margin-top: 20px;"> <p>Temperature-resistance characteristics of power transistor temperature sensor (Tho-P1)</p> <table border="1"> <caption>Approximate data from the graph</caption> <thead> <tr> <th>Temperature (°C)</th> <th>Power transistor sensor resistance (kΩ)</th> </tr> </thead> <tbody> <tr><td>0</td><td>180</td></tr> <tr><td>20</td><td>100</td></tr> <tr><td>40</td><td>40</td></tr> <tr><td>60</td><td>20</td></tr> <tr><td>80</td><td>10</td></tr> <tr><td>100</td><td>5</td></tr> <tr><td>120</td><td>3</td></tr> <tr><td>140</td><td>2</td></tr> </tbody> </table> </div>	Temperature (°C)	Power transistor sensor resistance (kΩ)	0	180	20	100	40	40	60	20	80	10	100	5	120	3	140	2	<p>Check and save the data of operating condition. Check the conditions whether it occurs immediately after the power on or during operation or stopping. Check the sensed value. Compare the temperature of Mente PC data with actual measured value.</p> <p>Insert the connector securely.</p> <p>Replace power transistor temperature sensor (Tho-P1).</p> <p>Replace outdoor unit control PCB.</p>
Temperature (°C)	Power transistor sensor resistance (kΩ)																		
0	180																		
20	100																		
40	40																		
60	20																		
80	10																		
100	5																		
120	3																		
140	2																		

Note:

Error code Remote control: E58 7-segment display: E58-1	LED	Green	Red	Content <h2 style="text-align: center;">Anomalous compressor by loss of synchronism</h2>
	Indoor	Keeps flashing	Stays Off	
	Outdoor	Keeps flashing	1 time flash	

1. Applicable model

Outdoor unit

2. Error detection method

E58 is displayed on 7-segment LED

3. Condition of error displayed

This anomaly is established 4 times within 15 minutes.

4. Presumable cause

- Insufficient time elapsed after the power supplied, before compressor startup. (Startup the compressor without crankcase heater ON)
- Compressor anomaly

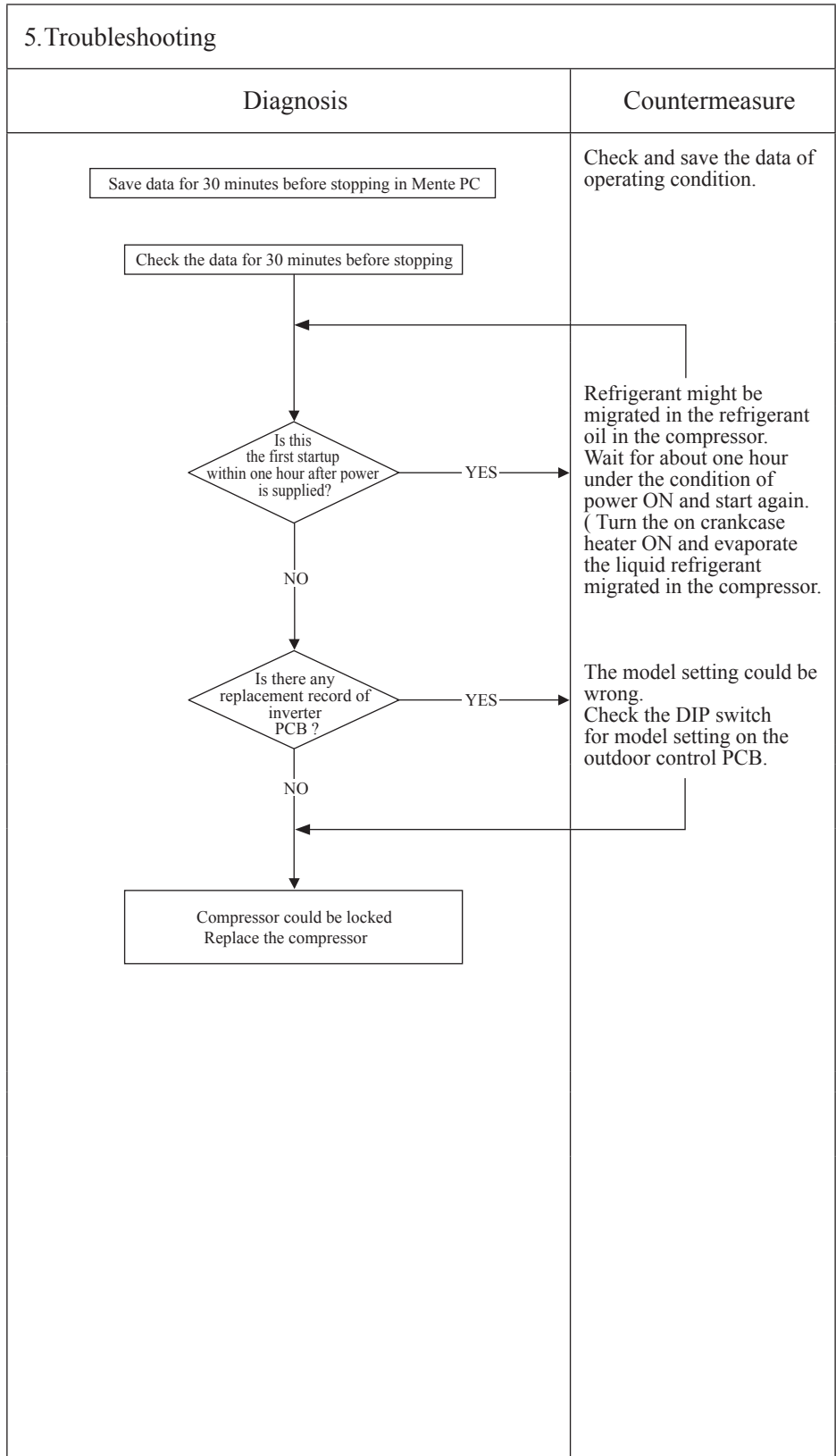

Note: If the error does not recur, connect the Mente PC and continue to collect data.

Error code Remote control: E59 7-segment display: E59-1	LED	Green	Red	Content <h2 style="text-align: center;">Compressor startup failure (CM1)</h2>
	Indoor	Keeps flashing	Stays Off	
	Outdoor	Keeps flashing	1 time flash	

1. Applicable model

Outdoor unit

2. Error detection method

When it fails to change over to the operation for rotor position detection of compressor motor

3. Condition of error displayed

If the compressor fails to startup for 20 times (10 patterns x 2 times) continuously.

4. Presumable cause

- Anomalous voltage of power source
- Anomalous components for refrigerant circuit
- Inverter PCB anomaly
- Loose connection of connector or cable
- Compressor anomaly (Motor or bearing)

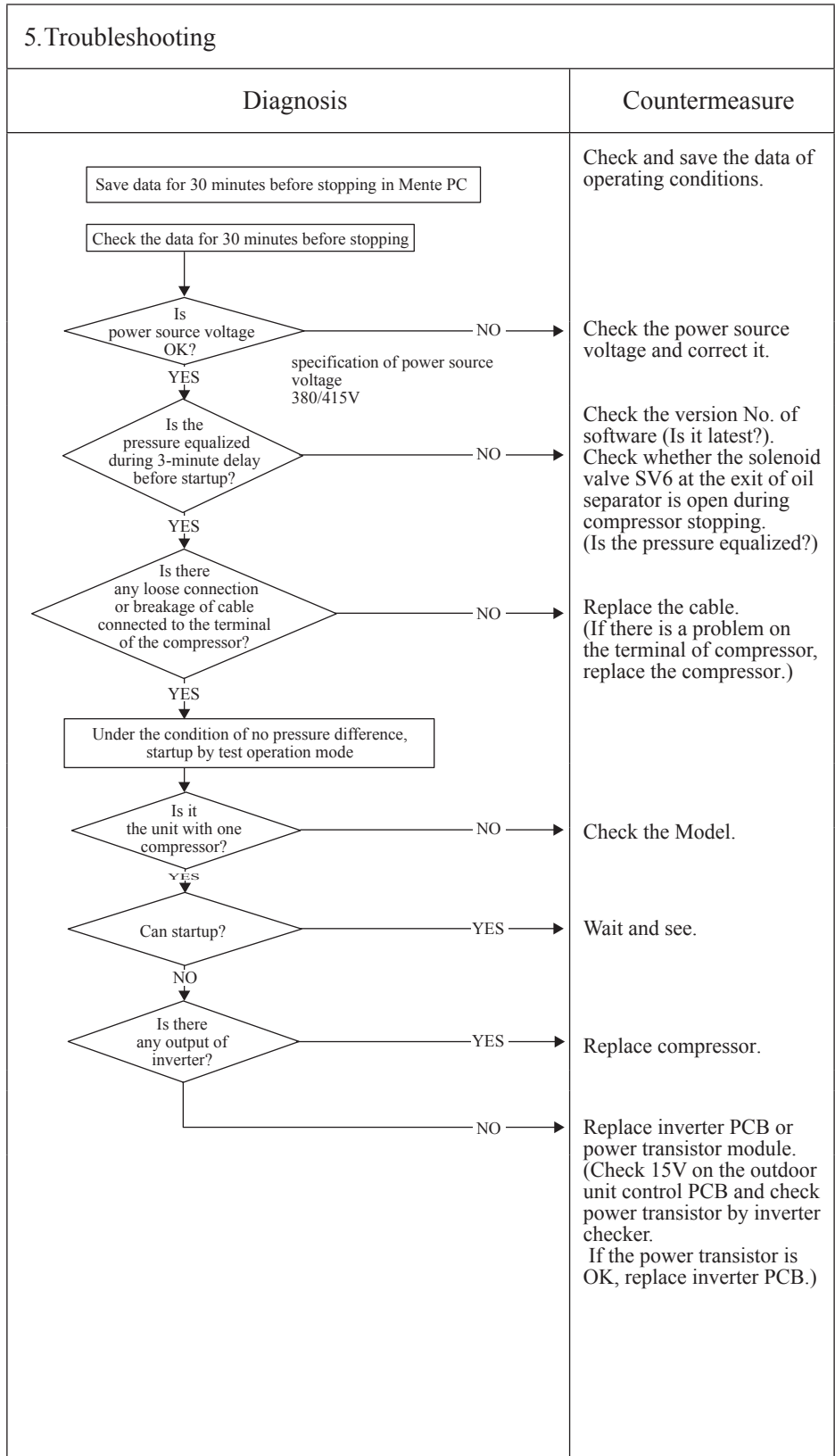

Note: If the error does not recur, connect the Mente PC and continue to collect data.

Error code Remote control: E60 7-segment display: E60-1	LED	Green	Red	Content Rotor position detection failure (CM1)
	Indoor	Keeps flashing	Stays Off	
	Outdoor	Keeps flashing	1 time flash	

1. Applicable model
Outdoor unit

2. Error detection method
Detection of the compressor rotor position.

3. Condition of error displayed
If it fails to detect the rotor position of compressor, after changing over to the operation of compressor rotor position detection, the compressor stops. When it is restart automatically after 3 minutes delay, this anomaly occurs 4 times within 15 minute after the initial detection

- 4. Presumable cause**
- Compressor anomaly
 - Inverter PCB anomaly
 - Anomaly of power source

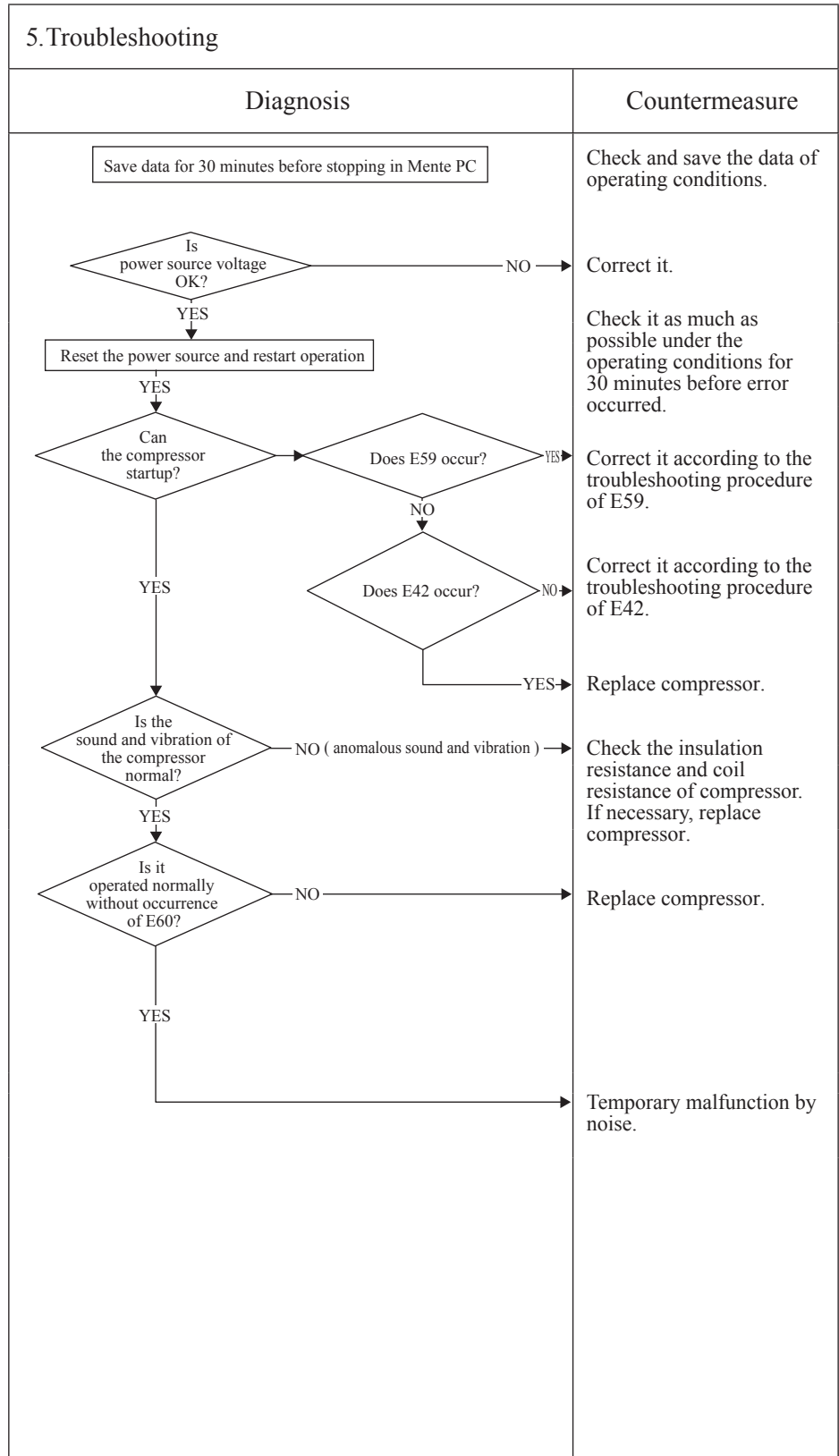

Note: If the error does not recur, connect the Mente PC and continue to collect data.

Error code Remote control: E63 7-segment display: E63	LED	Green	Red	Content <h2 style="text-align: center;">Emergency stop</h2>
	Indoor	Keeps flashing	Stays Off	
	Outdoor	Keeps flashing	1 time flash	

1. Applicable model
Indoor unit

2. Error detection method
When ON signal is inputted to the CnT terminal of indoor unit control PCB

3. Condition of error displayed
Same as above

4. Presumable cause
Factors for emergency stop



5. Troubleshooting	
Diagnosis	Countermeasure
<div style="border: 1px solid black; padding: 5px; width: fit-content; margin: 0 auto;">Save data for 30 minutes before stopping in Mente PC</div> <pre> graph TD A{Is the remote control setting of Emergency Stop "Valid"?} -- NO --> B[Replace remote control PCB.] A -- YES --> C{Is ON signal inputted to the CnT terminal of indoor unit control PCB?} C -- NO --> D[Replace indoor unit control PCB.] C -- YES --> E[Check the cause of emergency stop. (It is better to have the data for 30 minutes before stopping, when instructing the installer.)] </pre>	
	Check and save the data of operating conditions. Check the conditions whether it occurs immediately after the power on or during operation.

Note: Indoor unit detected emergency stop signal gives command "all stop"

2.4 Outdoor unit control PCB replacement procedure

PCB012D017G 

Precautions for Safety

- Since the following precaution is the important contents for safety, be sure to observe them.
WARNING and CAUTION are described as follows:
- | | |
|--|---|
|  WARNING | Indicates an imminently hazardous situation which will result in death or serious injury if proper safety procedures and instructions are not adhered to. |
|  CAUTION | Indicates a potentially hazardous situation which may result in minor or moderate injury if proper safety procedures and instructions are not adhered to. |

WARNING

- Securely replace PCB according to this following instruction.
If PCB is incorrectly replace, it will cause an electric shock or fire.
- Be sure to check that the power source for the outdoor unit is turned OFF before replace PCB,
The PCB replacement under current-carrying will cause an electric shock.
- After finishing PCB replacement, check that wiring is correctly connected with the PCB before power distribution, If PCB is incorrectly replace, it will cause an electric shock or fire.

CAUTION

- Bundle the wiring so as not to tense because it will cause an electric shock.

(Note) If cut the tie, the wiring cables should be bound with new tie again.

- Exchange the control PCB according to the following procedure.
 - ① Replace the control PCB after elapsing 3 minutes from power OFF.
(Be sure to measure voltage (DC) at both capacitor terminals (1. Power source for PCB 2. Power source for fan motor) and check that the voltage is discharged completely. (Refer to Fig.1))
 - ② Disconnect the connectors from the PCB.
 - ③ Disconnect the blue wiring passing through CT1 on the PCB before replace the control PCB.
 - ④ Set the setting switches (SW1-6) and jumper wires (J11-16) of new PCB same as previous PCB.
 - ⑤ Tighten up a screw after passing blue wiring through CT1 of the changed.
 - ⑥ Connect the connectors to the PCB. (Confirm the connectors are not half inserted.)

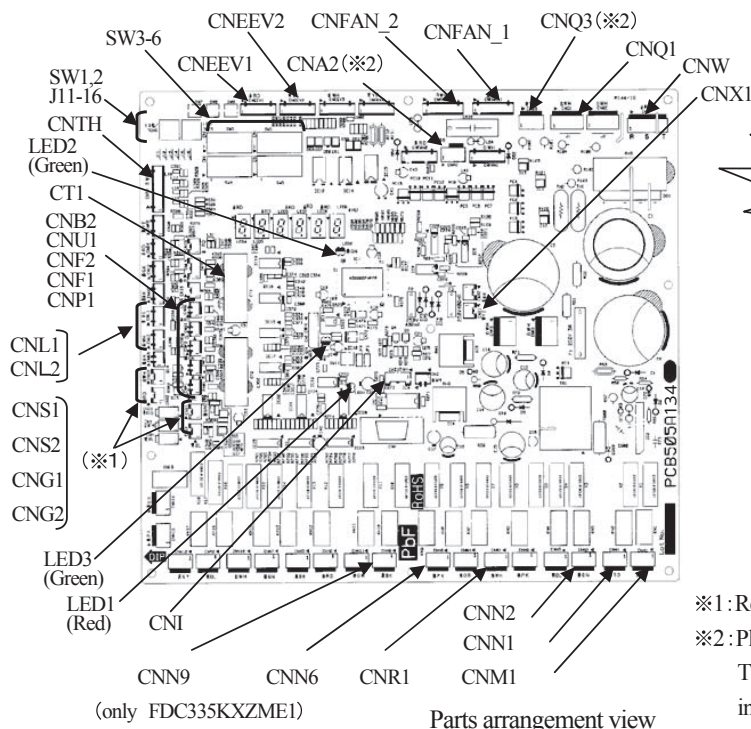

After elapsing 3 minutes
from power OFF

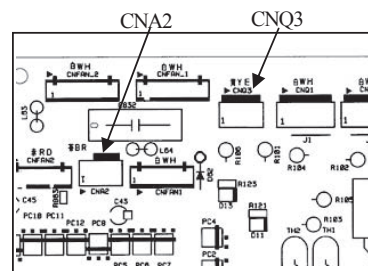

※1 : Reuse the parts used before the PCB exchange.

※2 : Please do not carry out wrong insertion.

The PCB will be destroyed if a mistake is made in putting CNA2 (brown) and CNQ3 (yellow).

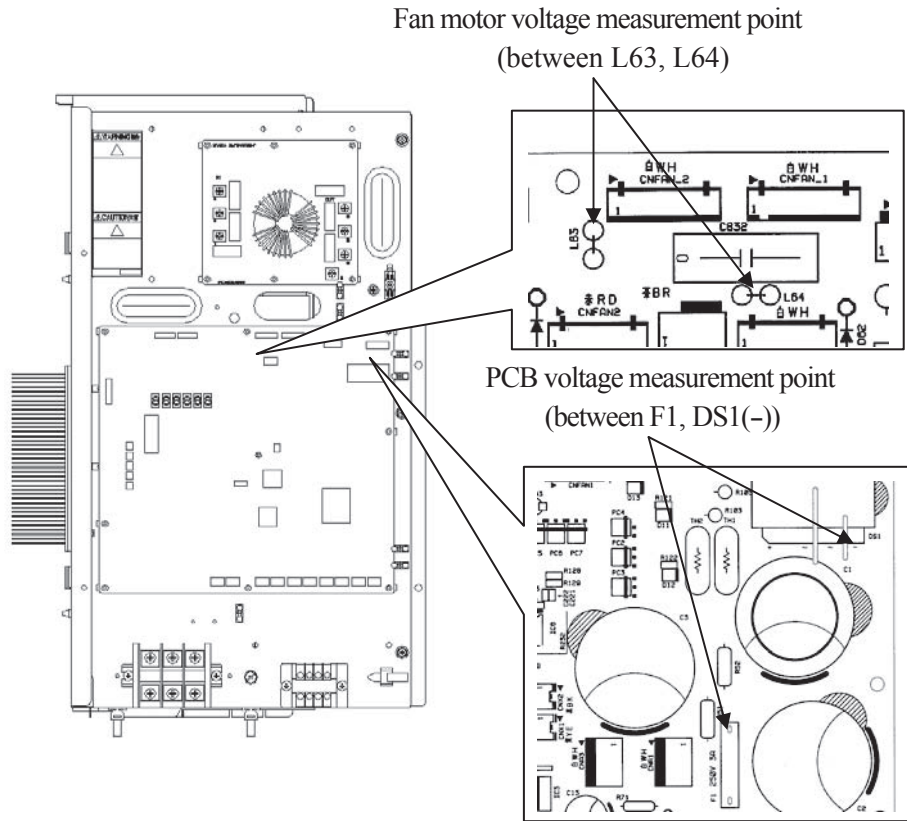
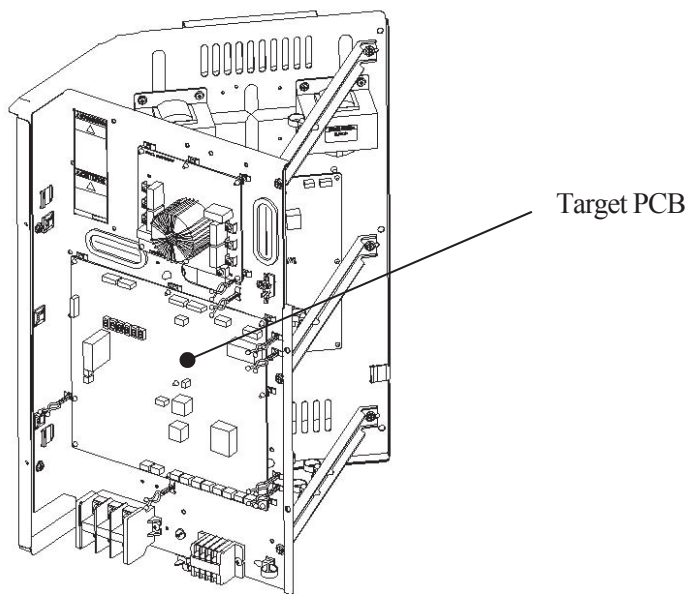

Fig.1 Voltage measurement points



Appearance of the controller

2.5 Inverter PCB replacement procedure

PCB012D018AB 

Precautions for Safety

- Since the following precaution is the important contents for safety, be sure to observe them.
WARNING and CAUTION are described as follows:



Indicates an imminently hazardous situation which will result in death or serious injury if proper safety procedures and instructions are not adhered to.



Indicates a potentially hazardous situation which may result in minor or moderate injury if proper safety procedures and instructions are not adhered to.

WARNING

- Securely replace PCB according to this following instruction.
If PCB is incorrectly replace, it will cause an electric shock or fire.
- Be sure to check that the power source for the outdoor unit is turned OFF before replace PCB,
The PCB replacement under current-carrying will cause an electric shock.
- After finishing PCB replacement, check that wiring is correctly connected with the PCB before power distribution, If PCB is incorrectly replace, it will cause an electric shock or fire.

CAUTION

- Bundle the wiring so as not to tense because it will cause an electric shock.

(Note) If cut the tie, the wiring cables should be bound with new tie again.

- Exchange the inverter PCB according to the following procedure.
 - ① Replace the inverter PCB after elapsing 3 minutes from power OFF.
(Be sure to measure voltage (DC) of two places (1. Power source for PCB 2. Power source for fan motor) and check that the voltage is discharged completely. (Refer to Fig.1))
 - ② Disconnect all of terminals and connectors from the inverter PCB before replace the inverter PCB.
 - ③ Replace to the new PCB.
 - ④ Set the setting switches (JSW 10, 11) of new PCB as shown in table 1.
 - ⑤ Connect all of terminals and connectors to the new PCB securely.
(Check the secure connection of terminals and connectors again)

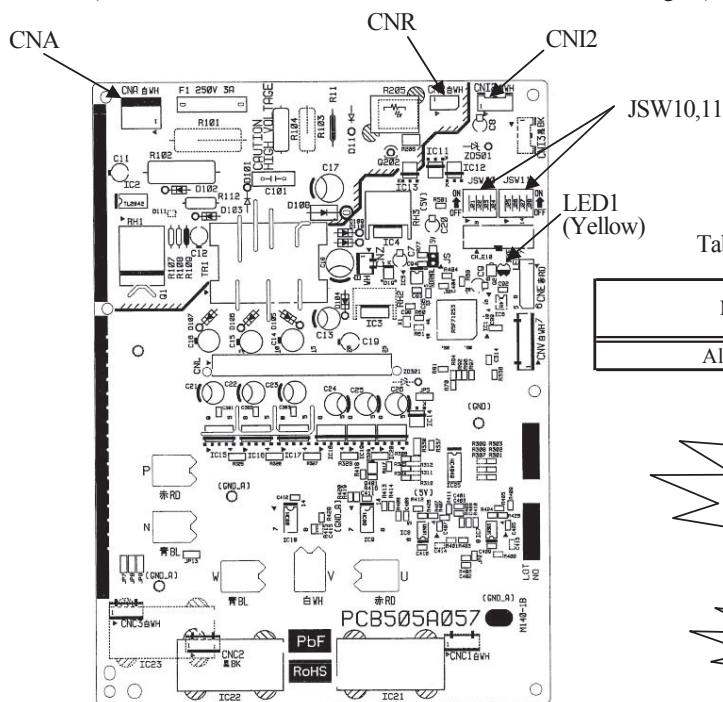

Parts Arrangement View

Table.1 Switch Setting

Model	JSW10	JSW11			
		1	2	3	4
All models	all OFF	OFF	ON	OFF	OFF



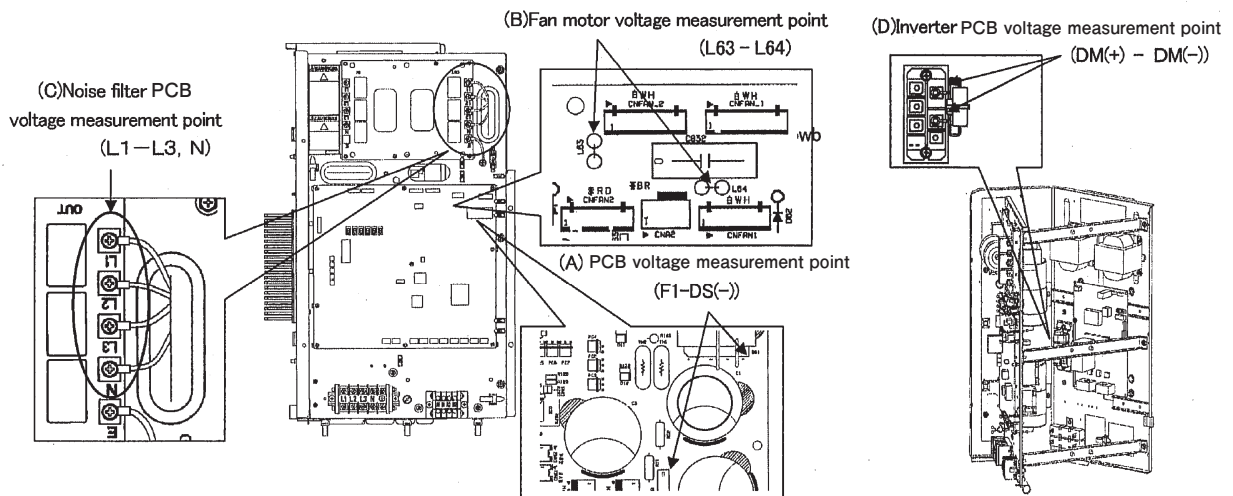
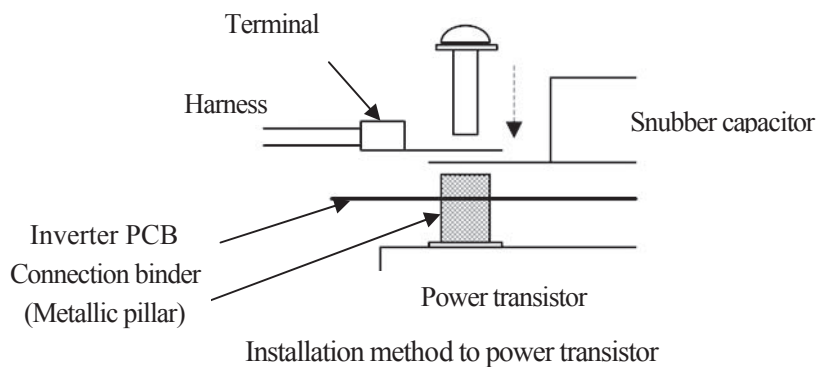

Fig.1 Voltage measurement points



- Procedure on tightening harness (snubber capacitor) and power transistor with screw.
 A metallic connection binder is set in each hole of the inverter PCB of "P", "N", "U", "V", and "W" beforehand. Then tighten the harness (snubber capacitor) and the power transistor with the screw together. (Connect snubber capacitor with "P" and "N".)

■ **Function of DIP switch for control**

•SW3 (Function setting)

Switch		Function
SW3-1	ON	Inspection LED reset
	OFF	Normal
SW3-7	ON	Forced cooling/heating
	OFF	Normal

•SW7, 8, 9 (Function setting)

Switch	Function
SW7	Data erase/data write
SW8	7-segment display No.UP order of 1
SW9	7-segment display No.UP order of 10

■ **Function of Jumper wire (J13, 15)
(With: Shorted / None: Opened)**

Jumper		Function
J13	With	External input Level input
	None	External input Pulse input
J15	With	Defrost time Normal
	None	Defrost time Cold weather region

■ **Function of Connector**

Connector	Function	Color	Connector	Function	Color
CNEEV1	Heating EEV (EEVH)	Red	CNF2	Sub-cooling coil temperature sensor (Tho-H)	Green
CNEEV2	Sub-cooling coil EEV (EEVSC)	Blue	CNP1	Power transistor temperature sensor (Tho-P1)	Yellow
CNA2	Power fan motor	Brown	CNL1	High pressure sensor (PSH)	Blue
CNFAN1	Fan motor 1 (FMo1)	White	CNL2	Low pressure sensor (PSL)	White
CNFAN2	Fan motor 2 (FMo2)	White	CNS1	External input	Green
CNQ1	High pressure switch (CM1)	White	CNS2	Demand input	Red
CNTH	Heat exchanger temperature sensor (Tho-R1)	White	CNN1	4-way switching solenoid valve (20S)	Red
	Discharge pipe temperature sensor (Tho-D1)		CNN2	Solenoid valve (oil return) (SV6)	Green
	Suction pipe temperature sensor (Tho-S)		CNN6	Solenoid valve (liquid bypass) (SV1)	Pink
	External air temperature sensor (Tho-A)		CNN9*	Solenoid valve (gas bypass) (SV11)	Black
CNB2	Heat exchanger temperature sensor (Tho-R2)	Red	CNM1	Solenoid for CM (52X1,2)	Gray
CNU1	Under-dome temperature sensor (Tho-C1)	Blue	CNR1	Crankcase heater (CH1)	White
CNF1	Sub-cooling coil temperature sensor (Tho-SC)	White			

*CNN9 : only FDC335KXZME1

•SW5 (Function setting)

	ON/OFF	Function	
SW5-1	ON	Test run switch	Test run
	OFF	Test run switch	Normal
SW5-2	ON	Test run operation mode	Cooling
	OFF	Test run operation mode	Heating
SW5-3	ON	Pump down switch	Pump down
	OFF	Pump down switch	Normal
SW5-5	ON	Superlink protocol: Previous SL	
	OFF	Superlink protocol: New SL	

● DIP Switch setting list

(1) Outdoor unit (a) Control PCB

Switch	Description	Default setting	Remarks
SW1	Outdoor address No. (Order of 10)	4	0-9
SW2	Outdoor address No. (Order of 1)	9	0-9
SW3-1	Inspection LED reset	Normal*/Reset	OFF Normal
SW3-2	Spare	OFF	keep OFF
SW3-3	Spare	OFF	keep OFF
SW3-4	Reserved	OFF	keep OFF
SW3-5	Check operation start	Normal*/Start	OFF Normal
SW3-6	Reserved	OFF	keep OFF
SW3-7	Forced heating/cooling	Normal*/Forced	OFF Normal
SW3-8	Reserved	OFF	keep OFF
SW4-1	Model selection	As per model	See table 1
SW4-2			
SW4-3			
SW4-4			
SW4-5	Demand ratio selection	OFF	See table 2
SW4-6		OFF	
SW4-7	Reserved	OFF	Keep OFF
SW4-8	Spare	OFF	Keep OFF
SW5-1	Test run SW	Normal*/Test run	OFF Normal
SW5-2	Test run mode	Heating*/Cooling	OFF Heating
SW5-3	Pump down operation	Normal*/Pump down	OFF Normal
SW5-4	Reserved	OFF	Keep OFF
SW5-5	Superlink selection	New SL*/Previous SL	OFF New SL(Auto)
SW5-6	Reserved	OFF	Keep OFF
SW5-7	Reserved	OFF	Keep OFF
SW5-8	Reserved	OFF	Keep OFF
SW6-1	Reserved	OFF	Keep OFF
SW6-2	Reserved	ON	Keep OFF
SW6-3	Spare	OFF	Keep OFF
SW6-4	Spare	OFF	Keep OFF
SW6-5	Spare	OFF	Keep OFF
SW6-6	Model selection	ON	
SW6-7	Spare	OFF	Keep OFF
SW6-8	Spare	OFF	Keep OFF
SW7	Data Erase/Write	Erase*/Write	OFF Erase
SW8	7-segment display code No. increase (Order of 1)	0	
SW9	7-segment display code No. increase (Order of 10)	0	
J10	Superlink terminal spare	Normal*/switch to spare	With Normal
J11	Power voltage selection	As per voltage	See table 3
J12			
J13	External input	Level*/Pulse	With Level
J14	Spare	With	Keep With
J15	Defrost start temperature	Normal*/Cold region	With Normal
J16	Outdoor unit type selection	KXR/KX	With KXR

* Default setting

Table 1: Model selection with SW4-1~SW4-4 and J16

	224	280	335
SW4-1	0	1	0
SW4-2	0	0	1
SW4-3	0	0	0
SW4-4	0	0	1
J16	None	None	None

Table 2: Demand ratio selection with SW4-5, SW4-6

SW4-5	SW4-6	Compressor capacity (%)
0	0	80
1	0	60
0	1	40
1	1	0

Table 3: Power voltage selection with J11, J12

	J11	J12
Outdoor unit		
380V 60Hz	0	1
380/415V 50Hz	0	0

(b) Inverter PCB

JSW10	1	OFF
	2	OFF
	3	OFF
	4	OFF
JSW11	1	OFF
	2	ON
	3	OFF
	4	OFF

(2) Indoor unit

Switch	Description	Default setting	Remarks
SW1	Indoor unit address No. (Order of 10)	0	0-9
SW2	Indoor unit address No. (Order of 1)	0	0-9
SW3	Outdoor unit address No. (Order of 10)	4	0-9
SW4	Outdoor unit address No. (Order of 1)	9	0-9
SW5-1	Superlink selection	Automatic*/Previous SL	OFF Automatic
SW5-2	Indoor unit address No. (Order of 100)	OFF 0	OFF: 0, ON: 1
SW6-1	Model selection	As per model	See table 1
SW6-2			
SW6-3			
SW6-4			
SW7-1	Test run, Drain motor	Normal*/Test run	OFF Normal
SW7-2	Reserved	OFF	keep OFF
SW7-3	Spare	OFF	keep OFF
SW7-4	Reserved	OFF	keep OFF
JSL1	Superlink terminal spare	Normal*/switch to spare	With Normal

* Default setting

Table 1: Indoor unit model selection with SW6-1~SW6-4

	P22	P28	P36	P45	P56	P71	P80	P90	P112	P140	P160	P224	P280
SW6-1	0	1	0	0	0	1	0	1	0	1	0	1	1
SW6-2	0	0	1	0	1	0	0	1	1	0	0	1	1
SW6-3	0	0	0	1	1	0	0	0	0	1	1	1	1
SW6-4	0	0	0	0	0	1	1	1	1	1	1	1	1

3. ELECTRICAL WIRING

Models FDC224KXZME1, 280KXZME1

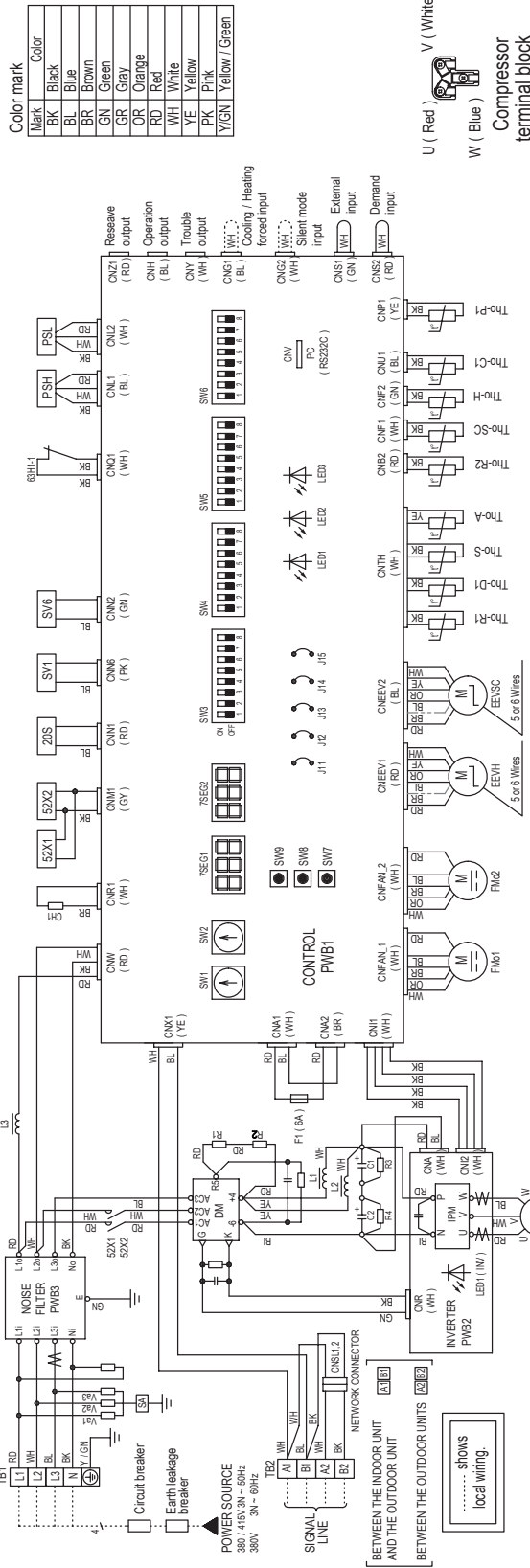

Mark	Color
BK	Black
BL	Blue
BR	Brown
GN	Green
GR	Gray
OR	Orange
RD	Red
WH	White
YE	Yellow
PK	Pink
Y/GN	Yellow / Green



Mark	Name
Tho-P1	Terminal block
Tho-A	External air temperature sensor
Tho-C1	Under-dome temperature sensor
Tho-D1	Discharge pipe temperature sensor
Tho-H	Super-cooling coil temperature sensor 2
Tho-P1	Power transistor temperature sensor
Tho-R1	Heat exchanger temperature sensor 1 (Ext / front)
Tho-R2	Heat exchanger temperature sensor 2 (Ext / rear)
Tho-S	Suction pipe temperature sensor
Tho-SC	Super-cooling coil temperature sensor 1
X01-03.06.09	Aux. relay
7SEG1	7-segment LED (Data display)
7SEG2	7-segment LED (Function display)
20S	4-way switching solenoid
52X1.2	Solenoid for CM
63H1-1	High pressure switch

Mark	Name
SW1	Address setting switch outdoor unit No. (2 digits)
SW2	Address setting switch outdoor unit No. (1 digit)
SW3-1	Inspection LED reset
SW3-2,5	Spare
SW3-6	ON Pipe washing mode
SW3-7	OFF Normal operation
SW3-8	ON Forced heating / cooling mode
SW4-1,4	OFF Normal operation
SW4-5,6	OFF Model setting
SW4-7,8	OFF Demand switching
SW5-1	ON Test run
SW5-2	OFF Normal operation
SW5-3	ON Cooling at test run
SW5-4	OFF Heating at test run
SW5-5	ON Pump-down operation
SW5-6	OFF Normal operation
SW5-7	Spare
SW5-8	ON Superlink communication
SW5-9	OFF Superlink II communication
SW6-1	Model setting
SW6-2	Data delete / write
SW6-3	7-segment indication up (1 digit)
SW6-4	7-segment indication up (2 digits)

Mark	Name
CH1	Crankcase heater
CM	Compressor motor
CNA-Z1	Connector
CT1	Current sensor
CT1.2	Electrolytic capacitor
DM	Diode module
EEVH	Heating expansion valve
EEVSC	Super-cooling coil expansion valve
FMo1,2	Blower motor
F1	Fuse
IPM	Intelligent power module
J11,12	Power source, voltage switching
J13	External input switching level / pulse
J14	Spare
J15	Defrost operation start temperature selection, normal / cold region
LED1	Inspection (Red)
LED2	Normal (Yellow) / Flashing
LED3	Normal (Green)
L1-F3	Service (Green)
PSH	DC reactor
PSI	High pressure sensor
PW1-3	Low pressure sensor
PCB	PCB
R1-4	Rush current suppression resistor
SV1	Solenoid valve (fluid return)
SV6	Solenoid valve (oil return)

PCB004Z334

Model FDC335KXZME1

Mark	Color
BK	Black
BL	Blue
BR	Brown
GN	Green
GR	Gray
OR	Orange
RD	Red
WH	White
YE	Yellow
PK	Pink
V/GN	Yellow / Green

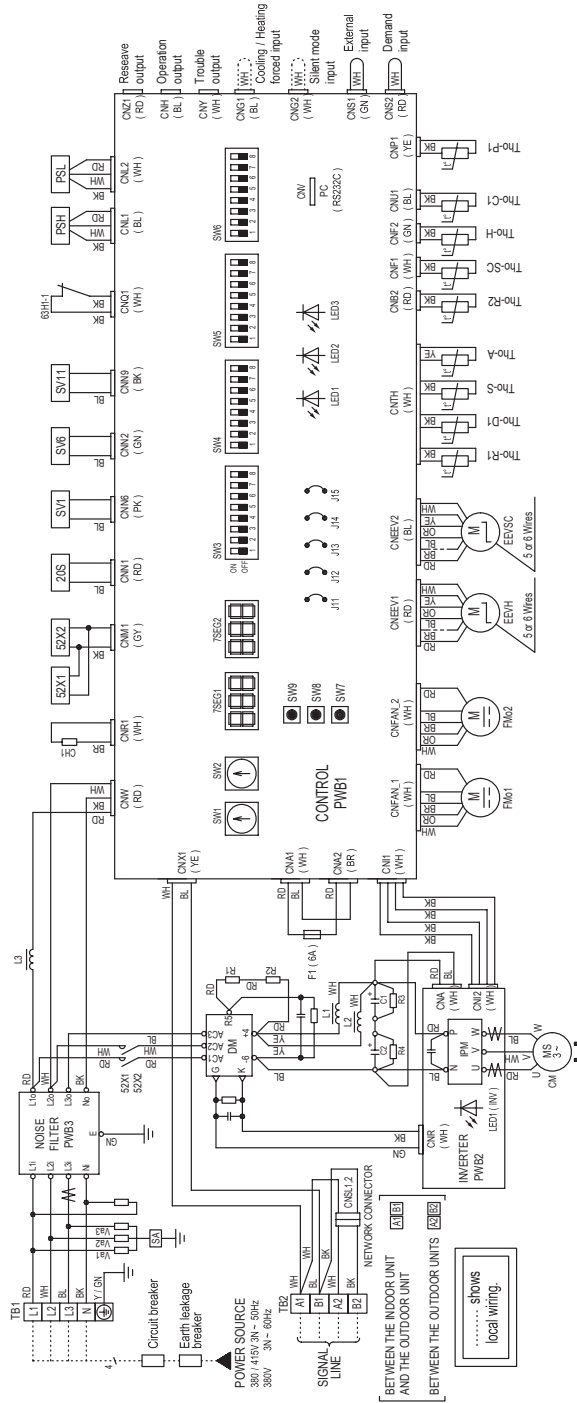

Mark	Name
TB1.2	Terminal block
Tho-A	External air temperature sensor
Tho-C1	Under-dome temperature sensor
Tho-D1	Discharge pipe temperature sensor
Tho-H	Super-cooling coil temperature sensor 2
Tho-P1	Power transistor temperature sensor
Tho-R1	Heat exchanger temperature sensor 1 (Exit / front)
Tho-R2	Heat exchanger temperature sensor 2 (Exit / rear)
Tho-S	Suction pipe temperature sensor
Tho-SC	Super-cooling coil temperature sensor 1
X01-03,06,09	Aux. relay
7SEG1	7-segment LED (Data display)
7SEG2	7-segment LED (Function display)
20S	4-way switching solenoid
5X1.2	Solenoid for CM
6BH-1-1	High pressure switch

Mark	Name
SW1	Address setting switch outdoor unit No. (2 digits)
SW2	Address setting switch outdoor unit No. (1 digit)
SW3-1	Inspection LED reset
SW3-2-5	Spare
SW3-6	ON: Pipe washing mode OFF: Normal operation
SW3-7	ON: Forced heating / cooling mode OFF: Normal operation
SW3-8	ON: Test mode OFF: Normal operation
SW4-1-4	Model setting
SW4-5,6	Demand switching
SW4-7,8	Spare
SW5-1	ON: Test run OFF: Normal operation
SW5-2	ON: Cooling at test run OFF: Heating at test run
SW5-3	ON: Pump-down operation OFF: Normal operation
SW5-4	Spare
SW5-5	ON: Superlink communication OFF: Superlink II communication
SW6	Model setting
SW7	Data delete / write
SW8	7-segment indication up (1 digit)
SW9	7-segment indication up (2 digits)

Mark	Name
CH1	Crankcase heater
CM	Compressor motor
CNA-Z1	Connector
CT1	Current sensor
C1.2	Electrolytic capacitor
DM	Diode module
EEVH	Heating expansion valve
EEVSC	Super-cooling coil expansion valve
F1	Fuse
IPM	Intelligent power module
J11,12	Power source, voltage switching
J13	External input switching level / pulse
J14	Spare
J15	Defrost operation start temperature selection, normal / cold region
LED1	Inspection (Red)
LED2	Normal (Yellow) / Flashing
LED3	Service (Green)
L1-L3	DC reactor
PSH	High pressure sensor
PSL	Low pressure sensor
PWB1-3	PCB
R1-4	Rush current suppression resistor
SV1	Solenoid valve (fluid return)
SV6	Solenoid valve (oil return)
SV11	Solenoid valve (gas bypass)

PCB004Z335

4. PIPING SYSTEM

Model FDC224KXZME1, 280KXZME1

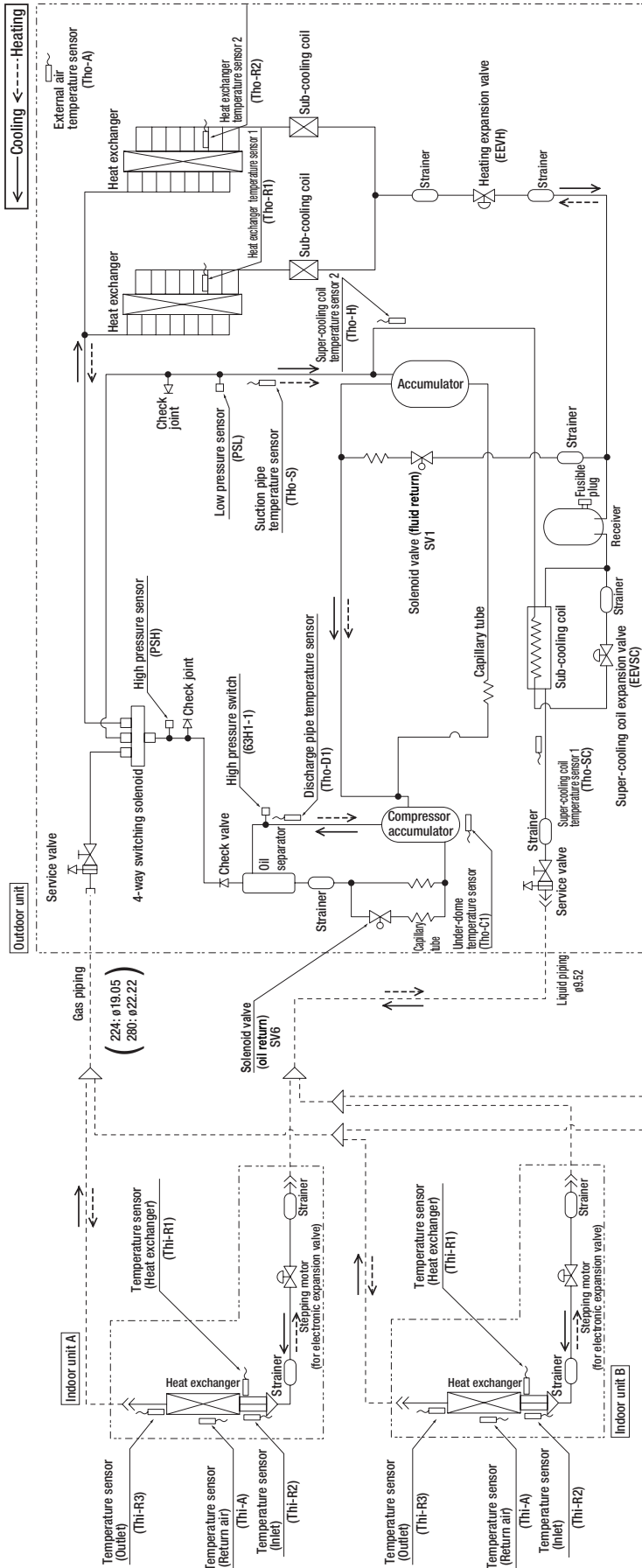

To next unit by turn

- Function of sensor
 - Low pressure sensor (PSL)
 - : Compressor control
 - Protection
 - 0.18 ON/0.236 OFF (MPa)
 - Error
 - 0.134 ON/0.18 OFF (MPa)
 - High pressure sensor (PSH)
 - : Compressor control
 - Protection
 - Cooling : 3.70 ON (MPa)
 - Heating : 3.00 ON (MPa)
 - Temperature sensor (THi-R1, R2)
 - : Heating operation : Indoor fan control
 - Cooling operation : Frost prevention
 - (THi-R3)
 - : Cooling superheat control
- Solenoid valve operation

Name	Control content
At inverter compressor start	: Open
During under-dome temperature control	: Open
During discharge temperature control	: Open
- Pressure switch setting value

Name	Setting value
High pressure switch (63H-1) [For protection]	4.15 open/3.15 close (MPa)
- Sensor (Tho-D1)
 - : For control of discharge pipe temperature
 - Sensor (Tho-A)
 - : For heating and cooling to low outdoor temperature, for control of defrost operation
 - Sensor (Tho-R1, R2)
 - : For control of defrost operation
 - Sensor (Tho-S)
 - : For control of suction pipe temperature
 - Sensor (Tho-SC)
 - : Sub-cooling coil control during cooling
 - Sensor (Tho-H)
 - : Sub-cooling coil control during cooling
 - Sensor (Tho-C1)
 - : Under-dome temperature control

Model FDC335KXZME1

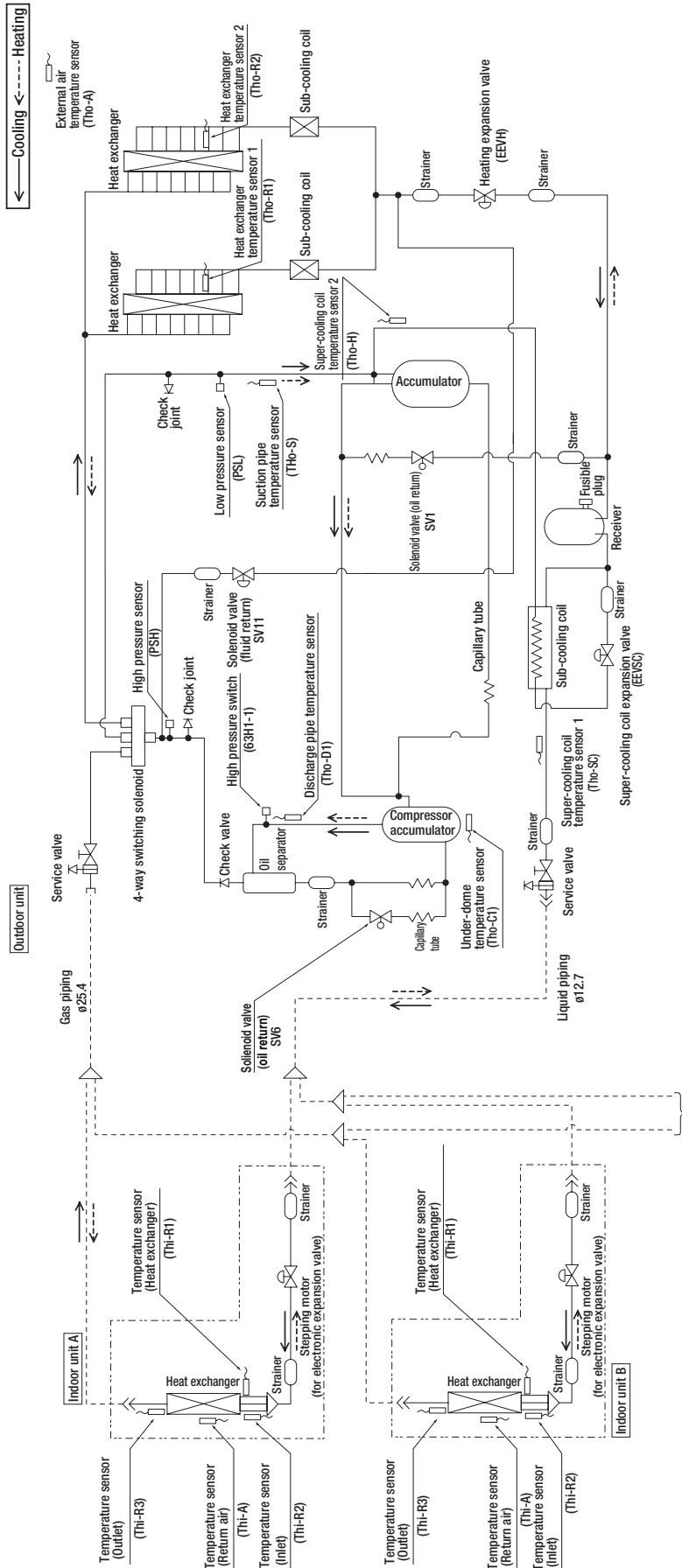

- Function of sensor
- Low pressure sensor (PSL) : Compressor control
- High pressure sensor (PSH) : Protection
- Temperature sensor (THi-R1, R2) : Heating and cooling to low outdoor temperature, for control of defrost operation
- Temperature sensor (THo-R1, R2) : For control of defrost operation
- Temperature sensor (THo-S) : For control of suction pipe temperature
- Temperature sensor (THo-H) : Sub-cooling coil control during cooling
- Temperature sensor (THo-D1) : Discharge pipe temperature control
- Temperature sensor (THo-C1) : Under-dome temperature control
- Temperature sensor (THo-C2) : Super-cooling coil control during cooling

- Pressure switch setting value

Name	Setting value
High pressure switch (63H-1) [For protection]	4.15 open/3.15 close (MPa)

- Solenoid valve operation

Name	Control content
SV6	At inverter compressor start : Open
SV1	During under-dome temperature control : Open
SV11	During discharge temperature control : Open
	During high pressure control at heating mode : Open

- Function of sensor
- Sensor (Tho-D1) : For control of discharge pipe temperature
- Sensor (Tho-A) : For heating and cooling to low outdoor temperature, for control of defrost operation
- Sensor (Tho-R1, R2) : For control of defrost operation
- Sensor (Tho-S) : For control of suction pipe temperature
- Sensor (Tho-SC) : Sub-cooling coil control during cooling
- Sensor (Tho-H) : Sub-cooling coil control during cooling
- Sensor (Tho-C1) : Under-dome temperature control

5. APPLICATION DATA

PSC012D119

5.1 Installation of outdoor unit

Outdoor unit capacity
FDC224- 335

- This installation manual deals with outdoor units and general installation specifications only. For indoor units, please refer to the respective installation manuals supplied with your units.
- Please read this manual carefully before you set to installation work and carry it out according to the instructions contained in this manual.

Application data

When install the unit, be sure to check whether the selection of installation place, power source specifications, usage limitation (piping length, height differences between indoor and outdoor units, power source voltage and etc.) and installation spaces.

SAFETY PRECAUTIONS

- We recommend you to read this "SAFETY PRECAUTIONS" carefully before the installation work in order to gain full advantage of the functions of the unit and to avoid malfunction due to mishandling.
- The precautions described below are divided into [⚠️ WARNINGS] and [⚡ CAUTIONS]. The matters with possibilities leading to serious consequences such as death or serious personal injury due to erroneous handling are listed in the [⚠️ WARNINGS] and the matters with possibilities leading to personal injury or damage of the unit due to erroneous handling including probability leading to serious consequences in some cases are listed in [⚡ CAUTIONS]. **These are very important precautions for safety. Be sure to observe all of them without fail.**
- The meaning of "Marks" used here are as shown on the right.

⊘ **Never do it under any circumstance.** ⚠️ ⚡ **Always do it according to the instruction.**

- Be sure to confirm no anomaly on the equipment by commissioning after completed installation and explain the operating methods as well as the maintenance methods of this equipment to the user according to the owner's manual.
- Keep the installation manual together with owner's manual at a place where any user can read at any time. Moreover if necessary, ask to hand them to a new user
- This unit complies with EN61000-3-3.

For outdoor unit, EN61000-3-2 is not applicable as consent by the utility company or notification to the utility company is given before usage. (Only 224, 280)
For outdoor unit, EN61000-3-12 is not applicable as consent by the utility company or notification to the utility company is given before usage. (Only 335)

⚠️ WARNING

- ⚠️ Installation must be carried out by the qualified installer. If you install the system by yourself, it may cause serious trouble such as water leaks, electric shocks, fire and personal injury, as a result of a system malfunction.
- Install the system in full accordance with the instruction manual. Incorrect installation may cause bursts, personal injury, water leaks, electric shocks and fire.
- Use the original accessories and the specified components for installation. If parts other than those prescribed by us are used, it may cause fall of the unit, water leaks, electric shocks, fire, refrigerant leak, substandard performance, control failure and personal injury.
- When installing in small rooms, take prevention measures not to exceed the density limit of refrigerant in the event of leakage accordance with ISO5149. Consult the expert about prevention measures. If the density of refrigerant exceeds the limit in the event of leakage, lack of oxygen can occur, which can cause serious accidents.
- Ventilate the working area well in the event of refrigerant leakage during installation. If the refrigerant comes into contact with naked flames, poisonous gas is produced.
- After completed installation, check that no refrigerant leaks from the system. If refrigerant leaks into the room and comes into contact with an oven or other hot surface, poisonous gas is produced.
- Hang up the unit at the specified points with ropes which can support the weight in lifting for portage. And to avoid jolting out of alignment, be sure to hang up the unit at 4-point support. An improper manner of portage such as 3-point support can cause death or serious personal injury due to falling of the unit.
- Install the unit in a location with good support. Unsuitable installation locations can cause the unit to fall and cause material damage and personal injury.
- Ensure the unit is stable when installed, so that it can withstand earthquakes and strong winds.
- Unsuitable installation locations can cause the unit to fall and cause material damage and personal injury.
- The electrical installation must be carried out by the qualified electrician in accordance with "the norm for electrical work" and national wiring regulation", and the system must be connected to the dedicated circuit.
- Power source with insufficient capacity and incorrect function done by improper work can cause electric shocks and fire.
- Be sure to shut off the power before starting electrical work.
- Failure to shut off the power can cause electric shocks, unit failure or incorrect function of equipment.
- Be sure to use the cables conformed to safety standard and cable ampacity for power distribution work.
- Unconformable cables can cause electric leak, anomalous heat production or fire.
- Use the prescribed cables for electrical connection, tighten the cables securely in terminal block and relieve the cables correctly to prevent overloading the terminal blocks.
- Loose connections or cable mountings can cause anomalous heat production or fire.
- Arrange the wiring in the control box so that it cannot be pushed up further into the box. Install the service panel correctly. Incorrect installation may result in overheating and fire.
- In connecting the power cable, make sure that no anomalies such as dust deposits, socket clogging or wobble are found and insert the plug securely.
- Accumulation of dust, clogging on the socket, or looseness of plugging can cause electric shocks and fire.
- Be sure not to reuse existing refrigerant pipes.
- Conventional refrigerant oil or chlorine contained in the conventional refrigerant which is remaining in the existing refrigerant pipes can cause deterioration of refrigerant oil of new unit. And 1.6 times higher pressure of R410A refrigerant than conventional one can cause burst of existing pipe, personal injury or serious accident.
- Do not perform brazing work in the airtight room. It can cause lack of oxygen.
- Use the prescribed pipes, flare nuts and tools for R410A. Using existing parts (for R22 or R407C) can cause the unit failure and serious accidents due to burst of the refrigerant circuit.
- Tighten the flare nut by using double spanners and torque wrench according to prescribed method. Be sure not to tighten the flare nut too much. Loose flare connection or damage on the flare part by tightening with excess torque can cause burst or refrigerant leaks which may result in lack of oxygen.
- Do not open the service valves for liquid line and gas line until completed refrigerant piping work, air tightness test and evacuation. If the compressor is operated in state of opening service valves before completed connection of refrigerant piping work, you may incur frost bite or injury from an abrupt refrigerant outflow and air can be sucked into refrigerant circuit, which can cause burst or personal injury due to anomalously high pressure in the refrigerant.
- Do not put the drainage pipe directly into drainage channels where poisonous gases such as sulphide gas can occur.
- Poisonous gases will flow into the room through drainage pipe and seriously affect the user's health and safety. It can also cause the corrosion of the indoor unit and resultant unit failure or refrigerant leak.
- Only use prescribed option parts. The installation must be carried out by the qualified installer.
- If you install the system by yourself, it can cause serious trouble such as water leaks, electric shocks, fire.
- Do not perform any change of protective device itself or its setup condition.
- The forced operation by short-circuiting protective device of pressure switch and temperature control or the use of non specified component can cause fire or burst.
- Be sure to switch off the power source in the event of installation, inspection or servicing.
- If the power source is not shut off, there is a risk of electric shocks, unit failure or personal injury due to the unexpected start of fan.
- Consult the dealer or an expert regarding removal of the unit.
- Incorrect installation can cause water leaks, electric shocks or fire.
- Stop the compressor before closing valve and disconnecting refrigerant pipes in case of pump down operation. If disconnecting refrigerant pipes in state of opening service valves before compressor stopping, you may incur frost bite or injury from an abrupt refrigerant outflow and air can be sucked, which can cause burst or personal injury due to anomalously high pressure in the refrigerant circuit.
- ⊘ Ensure that no air enters in the refrigerant circuit when the unit is installed and removed. If air enters in the refrigerant circuit, the pressure in the refrigerant circuit becomes too high, which can cause burst and personal injury.
- Do not run the unit with removed panels or protections.
- Touching rotating equipments, hot surfaces or high voltage parts can cause personal injury due to entrapment, burn or electric shocks.
- Be sure to fix up the service panels.
- Incorrect fixing can cause electric shocks or fire due to intrusion of dust or water.
- Do not perform any repairs or modifications by yourself. Consult the dealer if the unit requires repair.
- If you repair or modify the unit, it can cause water leaks, electric shocks or fire.

⚡ CAUTION

- ⚠️ Use the circuit breaker for all pole with correct capacity. Using the incorrect circuit breaker, it can cause the unit malfunction and fire.
- Take care when carrying the unit by hand. If the unit weighs more than 20kg, it must be carried by two or more persons. Do not carry by the plastic straps, always use the carry handle when carrying the unit by hand. Use gloves to minimize the risk of cuts by the aluminum fins.
- Dispose of any packing materials correctly. Any remaining packing materials can cause personal injury as it contains nails and wood. And to avoid danger of suffocation, be sure to keep the plastic wrapper away from children and to dispose after tear it up.
- Pay attention not to damage the drain pan by weld spatter when welding work is done near the indoor unit. If weld spatter entered into the indoor unit during welding work, it can cause pin-hole in drain pan and result in water leakage. To prevent such damage, keep the indoor unit in its packing or cover it.
- Be sure to insulate the refrigerant pipes so as not to condense the ambient air moisture on them. Insufficient insulation can cause condensation, which can lead to moisture damage on the ceiling, floor, furniture and any other valuables.
- Be sure to perform air tightness test by pressurizing with nitrogen gas after completed refrigerant piping work. If the density of refrigerant exceeds the limit in the event of refrigerant leakage in the small room, lack of oxygen can occur, which can cause serious accidents.
- Perform installation work properly according to this installation manual. Improper installation can cause abnormal vibrations or increased noise generation.
- ⚠️ Carry out the electrical work for ground lead with care. Do not connect the ground lead to the gas line, water line, lightning conductor or telephone line's ground lead. Incorrect grounding can cause unit faults such as electric shocks due to short-circuiting. Never connect the grounding wire to a gas pipe because if gas leaks, it could cause explosion or ignition.
- Earth leakage breaker must be installed. If the earth leakage breaker is not installed, it can cause fire or electric shocks.
- Do not use any materials other than a fuse with the correct rating in the location where fuses are to be used. Connecting the circuit with copper wire or other metal thread can cause unit failure and fire.
- Do not install the unit near the location where leakage of combustible gases can occur. If leaked gases accumulate around the unit, it can cause fire.
- Do not install the unit where corrosive gas (such as sulfuric acid gas etc.) or combustible gas (such as thinner and petroleum gases) can accumulate or collect, or where volatile combustible substances are handled. Corrosive gas can cause corrosion of heat exchanger, leakage of plastic parts and etc. And combustible gas can cause fire.
- Secure a space for installation, inspection and maintenance specified in the manual. Insufficient space can result in accident such as personal injury due to falling from the installation place.
- When the outdoor unit is installed on a roof or a high place, provide permanent ladders and handrails along the access route and fences and handrails around the outdoor unit. If safety facilities are not provided, it can cause personal injury due to falling from the installation place.
- Do not install not use the system close to the equipment that generates electromagnetic fields or high frequency harmonics. Equipment such as inverters, standby generators, medical high frequency equipments and telecommunication equipments can affect the system, and cause malfunctions and breakdowns. The system can also affect medical equipment and telecommunication equipment, and obstruct its function or cause jamming.
- Do not use the outdoor unit in a location where insects and small animals can inhabit. Insects and small animals can enter the electric parts and cause damage or fire. Instruct the user to keep the surroundings clean.
- Do not use the base frame for outdoor unit which is corroded or damaged due to long periods of operation.
- Using an old and damaged base frame can cause the unit falling down and cause personal injury.
- Do not install the unit in the locations listed below.
 - Locations where carbon fiber, metal powder or any powder is floating.
 - Locations where any substances that can affect the unit such as sulphide gas, chlorine gas, acid and alkaline can occur.
 - Vehicles and ships
 - Locations where cosmetic or special sprays are often used.
 - Locations with direct exposure of oil mist and steam such as kitchen and machine plant.
 - Locations where any machines which generate high frequency harmonics are used.
 - Locations with salty atmospheres such as coastlines
 - Locations with heavy snow (if installed, be sure to provide base frame and snow hood mentioned in the manual)
 - Locations where the unit is exposed to chimney smoke
 - Locations at high altitude (more than 1000m high)
 - Locations with ammoniac atmospheres (e.g. organic fertilizer).
 - Locations with calcium chloride (e.g. snow melting agent).
 - Locations where heat radiation from other heat source can affect the unit
 - Locations without good air circulation.
 - Locations with any obstacles which can prevent inlet and outlet air of the unit
 - Locations where short circuit of air can occur (in case of multiple units installation)
 - Locations where strong air blows against the air outlet of outdoor unit
 - Locations where an equipment affected by high harmonics is placed. (TV set or radio receiver is placed within 5m)
- Do not install the outdoor unit in the locations listed below.
 - Locations where discharged hot air or operating sound of the outdoor unit can bother neighborhood.
 - Locations where outlet air of the outdoor unit blows directly to an animal or plants. The outlet air can affect adversely to the plant etc.
 - Locations where vibration can be amplified and transmitted due to an insufficient strength of structure.
 - Locations where vibration and operation sound generated by the outdoor unit can affect seriously. (on the wall or at the place near bed room)
 - Locations where an equipment affected by high harmonics is placed. (TV set or radio receiver is placed within 5m)
 - Locations where drainage cannot run off safely.
- It can affect surrounding environment and cause a claim.
- Do not use the unit for special purposes such as storing foods, cooling precision instruments and preservation of animals, plants or art. It can cause the damage of the items.
- Do not touch any buttons with wet hands. It can cause electric shocks.
- Do not shut off the power source immediately after stopping the operation. Wait at least 5 minutes, otherwise there is a risk of water leakage or breakdown.
- Do not control the system with main power switch. It can cause fire or water leakage. In addition, the fan can start unexpectedly, which can cause personal injury.
- Do not touch any refrigerant pipes with your hands when the system is in operation.
- During operation the refrigerant pipes become extremely hot or extremely cold depending the operating condition, and it can cause burn injury or frost injury.
- Do not operate the outdoor unit with any article placed on it. You may incur property damage or personal injury from a fall of the article.
- Do not step onto the outdoor unit. You may incur injury from a drop or fall.

Notabilia as a unit designed for R410A

- Do not use any refrigerant other than R410A. R410A will rise to pressure about 1.6 times higher than that of a conventional refrigerant.
- A unit designed for R410A has adopted a different size outdoor unit service valve charge port and a different size check joint provided in the unit to prevent the charging of a wrong refrigerant by mistake. The processed dimension of the flared part of a refrigerant pipe and a flare nut's parallel side measurement have also been altered to raise strength against pressure. Accordingly, you are required to arrange dedicated R410A tools listed in the table on the right before installing or servicing this unit.
- Do not use a charge cylinder. The use of a charge cylinder will cause the refrigerant composition to change, which results in performance degradation.
- In charging refrigerant, always take it out from a cylinder in the liquid phase.
- All indoor units must be models designed exclusively for R410A. Please check connectable indoor unit models in a catalog, etc. (A wrong indoor unit, if connected into the system, will impair proper system operation)



Dedicated R410A tools	
a)	Gauge manifold
b)	Charge hose
c)	Electronic scale for refrigerant charging
d)	Torque wrench
e)	Flare tool
f)	Protrusion control copper pipe gauge
g)	Vacuum pump adapter
h)	Gas leak detector

1. BEFORE BEGINNING INSTALLATION (Check that the models, power source specifications, piping, wiring are correct.)

Caution

- Be sure to read this manual before installation to follow the proper installation methods.
- When installing the indoor unit, read the installation manual of indoor unit.
- Option distribution parts are required for the piping (Branch pipe set, header set). For details, refer to the catalog, etc.
- Make sure to install the earth leakage breaker. (Select a product compatible with high frequency.)
- There is risk of damaging the compressor if the unit is operated while the discharge pipe temperature sensor, suction pipe temperature sensor, pressure sensor, etc. are removed. Never attempt to operation in such condition.
- With this air-conditioning system, room temperature may rise, depending on installation conditions, while indoor units are stopped, because small quantity of refrigerant flows into the stopped indoor units if heating operation is conducted on the system.

Accessory

Name	Quantity	Location of use	
Wire 	2	Insert this in CnG on the outdoor unit PCB when using the silencing mode or forced cooling mode	Secured in the control box with adhesive tape.
Edging 	1	Use it for protection of a knock-out hole.	It is attached to the bracket with an adhesive tape in the proximity of the service valve.
Attached wire 	1	Use this when connecting gas pipe.	Attached on the base below the service valve.
Instruction manual	1	When the installation work is completed, give instructions to the customer and ask him/her to keep it.	Attached on the base below the service valve.

Combination pattern

- Combination pattern of outdoor units, number of indoor units connected and capacity of connection are as show in the table at right.
- It can be used in combination with the following indoor unit.

Indoor unit	Remote control		Connection OK/NO	Outdoor unit		Indoor unit	
	Capacity	Combination pattern		Number of units connected (unit)	Range of total capacity of connected indoor units		
FD△△△KXE6, KXZ	RC-E3 (2 cores), RC-E4 (2 cores), RC-E5 (2 cores), RC-EX1A (2 cores)	OK	224	Single	1-22	112-336	
FD△△△KXE4R, KXE4BR, KXE5R	RC-E1R (3 cores)	NO	280	Single	1-24	140-420	
FD△△△KXE4, KXE4(A), KXE4A	RC-E1 (3 cores)	NO	335	Single	1-24	167-502	

[Items sold separately]

Refrigerant pipe distribution parts, which are not contained in the package, will be required for installation. As for refrigerant pipe distribution parts, we offer branching pipe sets (Model type: DIS) and header sets (Model type: HEAD) as parts used on the indoor side of piping. Please select one suiting your application. In selecting distribution parts, please also refer to "4. REFRIGERANT PIPING." If you are not sure which parts to select, please consult with your dealer or the manufacture. Use refrigerant branching pipe sets and header sets designed exclusively for R410A without fail.

2. INSTALLATION LOCATION (Obtain approval from the customer when selecting the installation area.)

2-1. Selecting the installation location

- Where air is not trapped.
- Where the installation fittings can be firmly installed.
- Where any object does not prevent inlet or outlet air.
- Out of the heat range of other heat sources.
- Where strong winds will not blow against the outlet air.
- A place where stringent regulation of electric noises is applicable.
- Where it is safe for the drain water to be discharged.
- Where noise and hot air will not bother neighboring residents.
- Where snow will not accumulate.
- A place where no TV set or radio receiver is placed within 5m. (If electrical interference is caused, seek a place less likely to cause the problem)
- Do not install the unit in places which exposed to sea breeze (e.g. coastal area) or calcium chloride (e.g. snow melting agent), exposed to ammonia substance (e.g. organic fertilizer).

Please note

- If there is a possibility of a short-circuit, then install a flex flow adapter.
- When installing multiple units, provide sufficient intake space so that a short-circuit does not occur.
- In areas where there is snowfall, install the unit in a frame or under a snow hood to prevent snow from accumulating on it. (Inhibition of collective drain discharge in a snowy country)
- Do not install the equipment in areas where there is a danger for potential explosive atmosphere.
- Install the equipment in a location that can sufficiently support the weight of the equipment.
- If a unit is installed into a special environment as shown below, there will be a danger that the corrosion of the outdoor unit or its malfunctioning is caused. If this is the case, please consult with the distributor from whom you have purchased the unit.
 - Where corrosive gas is generated (such as a hot-spring resort area).
 - Where the unit is subject to sea breezes (coastal area).
 - Where the unit is subject to oil mists.
 - Where equipment generating electromagnetic waves exists in the vicinity.
- When strong winds occur
 - Where it is likely that the unit is subjected to strong winds, provide wind guards according to the following guidelines. Strong winds can cause performance degradation, an accidental stop due to a rise of high pressure and a broken fan.

CAUTION
Please leave sufficient clearance around the unit without fail. Otherwise, a risk of compressor and/or electric component failure may arise.

① Place the unit outlet pipe perpendicular to the wind direction.

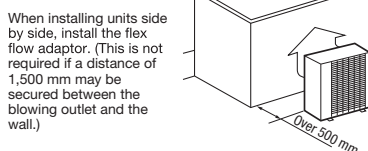

② Please install so the direction of the air from the blowing outlet will be perpendicular to the direction of the wind.

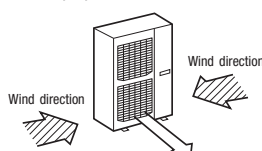

③ When the foundation is not level, use wires to tie down the unit.

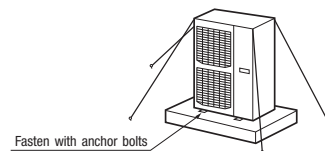

2-2. Installation space (Ex. servicing space)

- Minimum installation space
(Please select an installation point with due attention to the direction of installation of the refrigerant pipe)
(If the installation conditions shown in this drawing are not satisfied, please consult with your dealer or the manufacturer.)
- When two or more units are installed in a line, secure a service space of minimum 250 mm between each pair of neighboring units. The units can be operated, however, if they are separated by more than 10 mm each other. Where this minimum space is not available, it may be adapted by moving one of the units, for example, during the service work.
- Don't install at a place where it will be surrounded with walls in four directions.
Even when it is not surrounded with walls in four directions and it is met the installation conditions as shown by this figure, if there is risk of short-circuit, install the flex flow adaptor to prevent the short-circuit.
- There must be a 1-meter or larger space in the above.
- A barrier wall placed in front of the exhaust diffuser must not be higher than the unit.

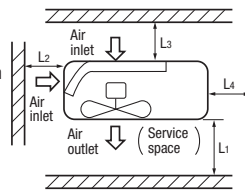

(Unit : mm)

Size	Sample I	Sample II	Sample III
L 1	Open	Open	1500 (500) ^{*1}
L 2	300	5	Open
L 3	300	300	300
L 4	250 (5) ^{*2}	250 (5) ^{*2}	250 (5) ^{*2}

^{*1} Figure in () shows the value applicable when the flex flow adaptor is installed.
^{*2} Under the setting condition as specified in (), it is necessary to secured 250 mm for the dimension L4 when replacing the compressor. Establish this for example by moving the unit during the work.

3. Unit delivery and installation

Caution Attach the ropes on the unit and carry it in avoiding displacement of gravity center.
Improper slinging may cause the unit to lose balance and fall.

3-1. Delivery

- Deliver the unit in the packing to the specified installation place.
- To hoist the unit, attach a pair of textile ropes with cushion materials attached to protect it.

Request

Put cushion materials between the unit and the ropes to avoid damages.

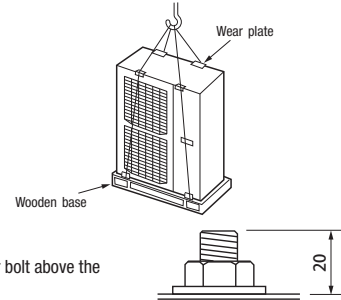

3-2. Cautions for installation

- Make sure to lock the fixing legs of outdoor unit with 4 pieces of anchor bolt (M10). Best margin of protrusion for bolt above the floor is 20 mm.
- When installing the unit, make sure to lock its legs with the following bolts.

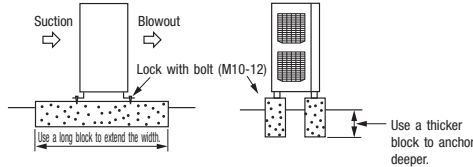
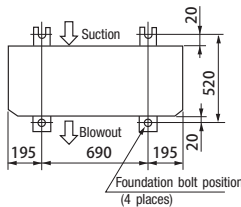

- The protrusion of an anchor bolt on the front side must be kept within 15 mm.
 - Securely install the unit so that it does not fall over during earthquakes or strong winds, etc.
 - Refer to the above illustrations for information regarding concrete foundations.
 - Install the unit in a level area. (With a gradient of 5 mm or less.)
- Improper installation can result in a compressor failure, broken piping within the unit and abnormal noise generation.

Important In case that the unit operates in cooling mode, when the outdoor temperature is -5°C or lower, please equip a flex flow adapter and a snow guard hood (option) on the unit.

4. REFRIGERANT PIPING

4-1. Determination of piping specifications (Please select from the following matrix according to indoor unit specifications and installation site conditions.)

(1) Limitation on use of pipes

- When arranging pipes, observe the restrictions on use concerning the longest distance of (1), total piping length, allowable pipe length from initial branching and allowable difference of height (difference between heads).
- Avoid any trap () or bump () in piping as they can cause fluid stagnation.
- Maximum length (To the furthest indoor unit) ... Actual length Less than 160 m (Actual length less than 185 m)
It is required to change the pipe diameter when the actual length exceeds 90 m.
Determine the size of main pipe, referring to the table of main pipe selection table of (3) (a).
- Total piping length 510 m or less
- Length of main pipe 130 m or less
- Allowable pipe length from initial branching 90 m or less
- Difference in pipe lengths between indoor units, however, is 40 m or less.
- Allowable difference in height (Difference of heads)
 - When an indoor unit is positioned at a higher place 50 m or less
 - When an outdoor unit is positioned at a lower place 40 m or less
 - Difference of heights between indoor units in a system 18 m or less
 - Difference of heights between initial branching and indoor unit ... 18 m or less

CAUTION

Make sure to install within the range of limitation. Otherwise, resulting malfunction of compressor may not be warranted. Observe always the limitation of use during installation.

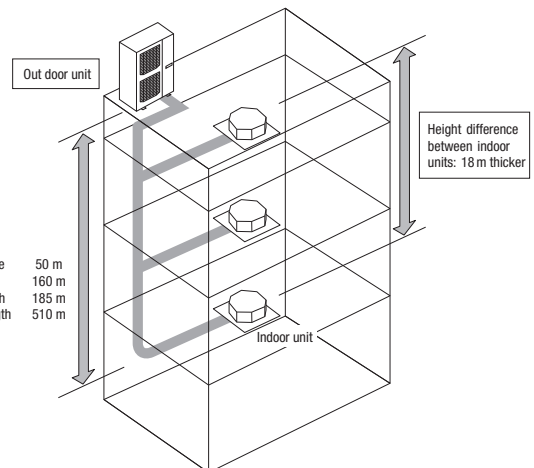

(2) Selection of pipe material

- Use pipes with the inside clean and free from any harmful sulfur, oxides, dirt, chips & oil, or moisture (contamination).
- Use following refrigerant pipes.
Material ... Phosphate deoxidation treated seamless pipe (C1220T-O, 1/2H, JIS H 3300) C1220T-1/2H for O.D. $\phi 19.05$ or more, or C1220T-O for $\phi 15.8$ or less
- Wall thickness and size - Select according to the guide for pipe size selection
(This product uses R410A. Since, in case of pipes in the size of $\phi 19.05$ or more, materials of -O lacks sufficient capacity to withstand pressure, make sure to use pipes of 1/2H material and thickness larger than the minimum thickness.)
- When a pipe is branched, make sure to use our branching set or header set.
- When setting branching pipes, take care of the mounting direction and consult carefully with the instruction manual.
- Regarding the handling of service valve, refer to 4-3 (1) Operating method of service valve.

(3) Pipe size selection

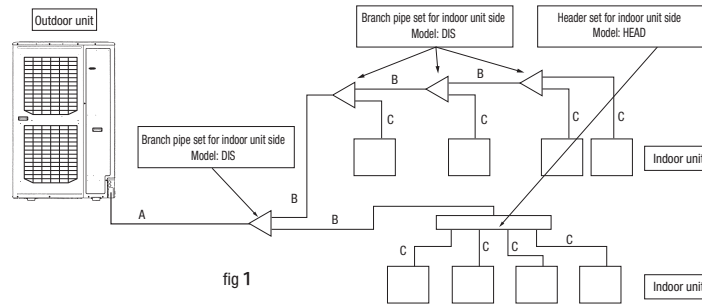

fig 1

(a) Main pipe (Between branch at outdoor unit side - initial branch at indoor unit side): Section A in Fig. 1

When the maximum length (to the furthest indoor unit from outdoor unit) is 90 m or more (actual length), change the size of main pipe as shown by the following table.

Outdoor unit	Main pipe size (Ordinary)		Pipe size for actual length longer than 90 m	
	Gas pipe	Liquid pipe	Gas pipe	Liquid pipe
224	ø19.5×t1.0	ø9.52×t0.8	ø22.22×t1.0	ø12.7×t0.80
280	ø22.22×t1.0		ø25.4(ø22.22)×t1.0	
335	ø25.4(ø22.22)×t1.0	ø12.7×t0.8		

Make sure to use the attached pipes in the length as shown at left.

For ø19.05 or larger, use C1220T-1/2H material.

(b) Between initial branch at indoor unit side- indoor unit side: Section B in Fig. 1

Select from following table based on the total capacity of indoor units connected at the downstream side. However, it should never exceed the size of main pipe (Section A in Fig. 1).

Total capacity of indoor units	Gas pipe	Liquid pipe
Less than 70	ø12.7 ×t1.0	ø 9.52×t0.8
70 - 180	ø15.88×t1.0	
180 - 371	ø19.05×t1.0 *1	ø12.7×t0.8
371 - 540	ø25.4(ø22.22)×t1.0	ø15.88×t1.0

For ø19.05 or larger, use C1220T-1/2H material.

*1: When connecting indoor units of 280 at the downstream and the main gas pipe is of ø22.22 or larger, use the pipe of ø22.22x t1

(c) Between branching at indoor unit side - indoor unit side: Section C in Fig. 1

According to the table of pipe size for indoor unit. However, it should never exceed the size of main pipe (Section A in Fig. 1).

Indoor unit	Capacity	Gas pipe	Liquid pipe
		22, 28	ø 9.52×t0.8
36, 45, 56		ø 12.7×t0.8	
71, 80, 90, 112, 140, 160		ø15.88×t1.0	ø9.52×t0.8
224		ø19.05×t1.0	
280		ø22.22×t1.0	

For ø19.05 or larger, use C1220T-1/2H material.

(4) Selection of the branch set for indoor unit side

(a) Selection of the branch pipe set

- Size of branch pipe varies depending on the capacity of connected indoor units (total capacity at downstream). Select it from the table at right.

Request

- Adjust the indoor unit and the size of branch pipe at the indoor unit side according to the size of pipe connected to indoor unit.
- Install the branch joint (both of gas and fluid) so that it will become "Horizontal branching" or "Vertical branching".

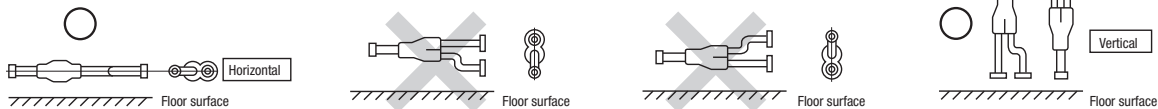

Total capacity at downstream	Branch pipe set
Less than 180	DIS-22-1G
180 - 371	DIS-180-1G
371 - 540	DIS-371-1G

(b) Selection of the header set

- Connect a plugged pipe (field provided) at the branch point (indoor unit connecting side) depending on the number of units connected.
- For the size of plugged pipe, refer to the header set (option item).

Request

- Adjust the header and indoor unit pipes to the size of pipes for connected indoor units.
- Install the header at the gas side to be "Horizontal branching" and, at the fluid side, that the branch is provided at the downstream side.
- Header is not allowed to receive indoor units of 224 or 280.

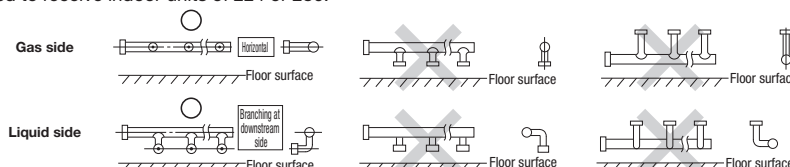

Total capacity at downstream	Header set model	Number of branches
Less than 180	HEAD4-22-1G	Max. 4 branches
180 - 371	HEAD6-180-1G	Max. 6 branches
371 - 540	HEAD8-371-2	Max. 6 branches

4-2. Piping work

(1) Pipe connecting position and pipe outgoing direction

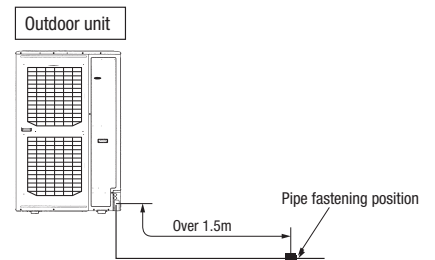
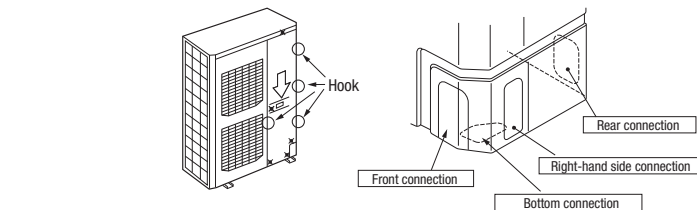
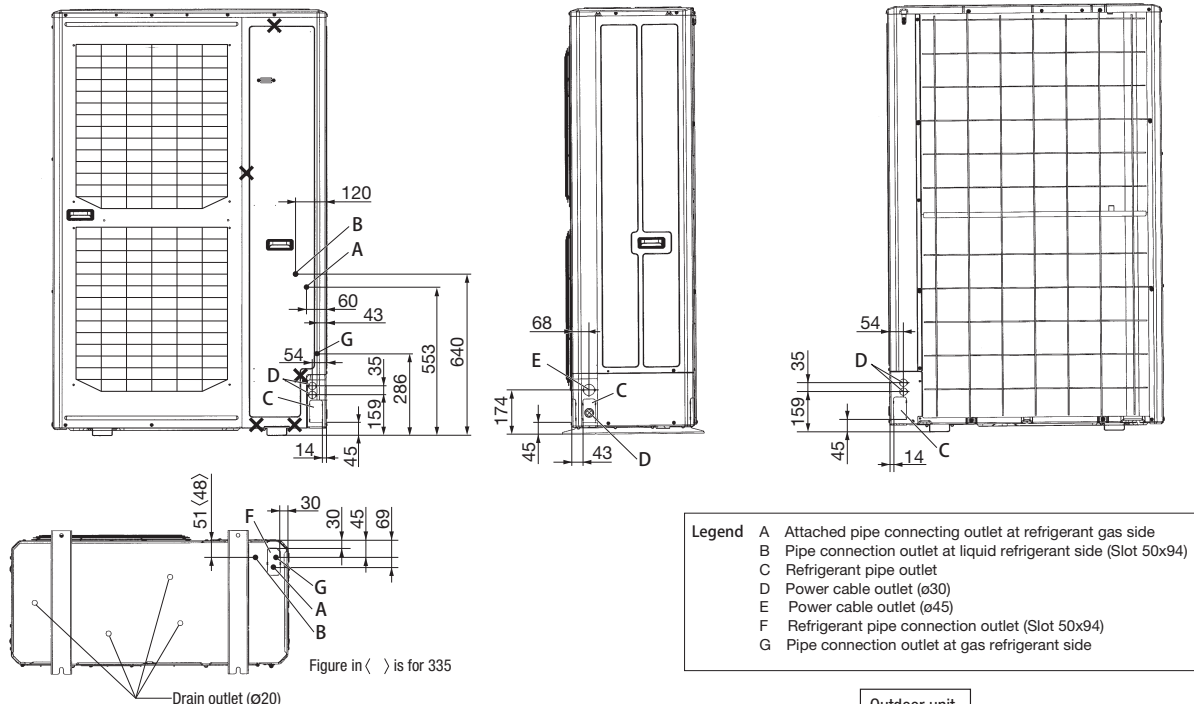

- First remove the five screws (X mark) of the service panel and push it down into the direction of the arrow mark and then remove it by pulling it toward you.
- The pipe can be laid in any of the following directions: side right, front, rear and downward.
- Remove a knock-out plate provided on the pipe penetration to open a minimum necessary area and attach an edging material supplied as an accessory by cutting it to an appropriate length before laying a pipe.
- In laying pipes on the installation site, cut off the casing's half blank that covers a hole for pipe penetration with nippers.
- If there is a risk of small animals entering from the pipe penetration part, close the part with some sealing material or the like (to be arranged on the installer's part).
- In the case of an installation using a collective drain system, use a port other than the bottom one to take out cables and pipes. If the bottom port is used, seal it thoroughly so that drain water may not spill out.
- Use an elbow (to be arranged on the user's part) to connect control valves to the piping.
- In anchoring piping on the installation site, give 1.5m or a longer distance between an outdoor unit and an anchoring point where the piping is secured as illustrated below. (A failure to observe this instruction may result in a pipe fracture depending on a method of isolating vibrations employed.)
- The pipe should be anchored every 1.5m or less to isolate the vibration.

(2) Field piping work

Important

- Please take care so that installed pipes may not touch components within a unit.
- **During the pipe installation at site, keep the service valves shut all the time.**
- Give **sufficient protections** (compressed and brazed or by an adhesive tape) **to pipe ends so that any water or foreign matters may not enter the pipes.**
- In bending a pipe, bend it **to the largest possible radius (at least four times the pipe diameter)**. Do not bend a pipe repeatedly to correct its form.
- An outdoor unit's pipe and refrigerant piping are to be flare connected. Flare a pipe after engaging a flare nut onto it. A flare size for R410A is different from that for conventional R407C. Although we recommend the use of flaring tools developed specifically for R410A, conventional flaring tools can also be used by adjusting the measurement of protrusion B with a protrusion control gauge.
- Be sure to use the accessory pipe for connection to the gas service valve. For details, refer to the installation manual of the accessory pipe.
- Tighten a flare joint securely **with two spanners**. Observe flare nut tightening torque specified in the table below.

CAUTION

If you tighten it without using double spanners, you may deform the service valve, which can cause an inflow of nitrogen gas into the outdoor unit.

Copper pipe outer diameter	Flare nut parallel side measurement: H (mm)		A	Flared pipe end: A (mm)		Copper pipe outer diameter	Copper pipe protrusion for flaring: B (mm)	
	H			A			In the case of a rigid (clutch) type	
φ 6.35	17		0	-0.4	φ 6.35	0-0.5	0.7-1.3	
φ 9.52	22			9.1	φ 9.52			
φ 12.7	26			13.2	φ 12.7			
φ 15.88	29			16.6	φ 15.88			
				19.7				

For service valves both at the fluid and gas sides, fix the valve body and tighten to adequate torque as shown at right.

Service valve size (mm)	Tightening torque (N·m)	Tightening angle (°)	Recommended length of tool handle (mm)
Ø6.35 (1/4")	14-18	45-60	150
Ø9.52 (3/8")	34-42	30-45	200
Ø12.7 (1/2")	49-61	30-45	250
Ø15.88 (5/8")	68-82	15-20	300
Ø19.05 (3/4")	100-120	15-20	450

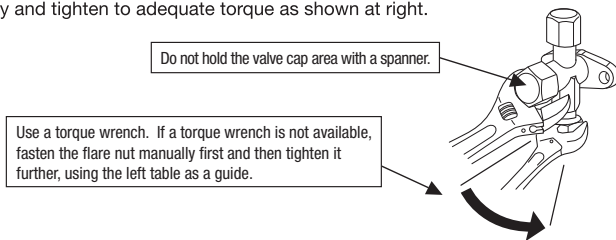

- Do not apply any oil on a flare joint.
- **Blazing must be performed under a nitrogen gas flow.** Without nitrogen gas, a large quantity of foreign matters (oxidized film) are created, causing a critical failure from capillary tube or expansion valve clogging.
- Brazing of the service valve and the pipes should be performed while cooling the valve body with a wet towel.
- Perform flushing. To flush the piping, charge nitrogen gas at about 0.02 MPa with a pipe end closed with a hand. When pressure inside builds up to a sufficient level, remove the hand to flush. (in flushing a pipe, close the other end of the pipe with a plug).

Operation procedure

- ① **During the pipe installation at site, keep the service valves shut all the time.**
- ② **Blazing must be performed under a nitrogen gas flow.** Without nitrogen gas, a large quantity of foreign matters (oxidized film) are created, causing a critical failure from capillary tube or expansion valve clogging.

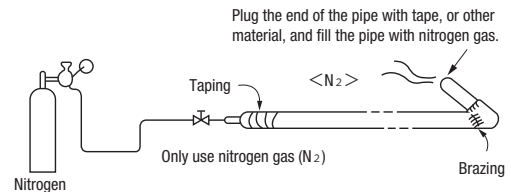

- ③ Give **sufficient protections** (compressed and brazed or with an adhesive tape) **so that water or foreign matters may not enter the piping.**

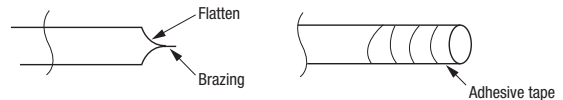

- ④ Perform flushing. To flush the piping, charge nitrogen gas at about 0.02 MPa with a pipe end closed with a hand. When pressure inside builds up to a sufficient level, remove the hand to flush. (in flushing a pipe, close the other end of the pipe with a plug).

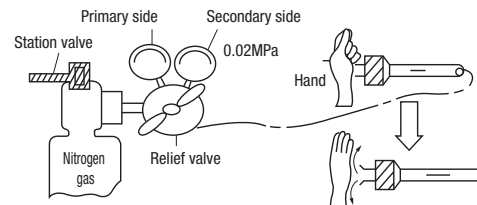

4-3. Air tightness test and air purge

(1) Air tightness test

- ① Although an outdoor unit itself has been tested for air tightness at the factory, please check the connected pipes and indoor units for air tightness from the check joint of the service valve on the outdoor unit side. While conducting a test, **keep the service valve shut all the time.**
- ② Since refrigerant piping is pressurized to the design pressure of a unit with nitrogen gas for testing air tightness, please connect instruments according to the drawing below. Under no circumstances should chlorine-based refrigerant, oxygen or any other combustible gas be used to pressurize a system. **Keep the service valve shut all the time.** Do not open it under any circumstances. **Be sure to pressurize all of the liquid, gas pipes.**
- ③ In pressurizing the piping, do not apply the specified level of pressure all at once, but gradually raise pressure.
 - a) **Raise the pressure to 0.5 MPa, and then stop. Leave it for five minutes or more** to see if the pressure drops.
 - b) **Then raise the pressure to 1.5 MPa, and stop. Leave it for five more minutes** to see if the pressure drops.
 - c) Then raise the pressure to the specified level (4.15 MPa), and record the ambient temperature and the pressure.
 - d) **If no pressure drop is observed with an installation pressurized to the specified level and left for about one day, it is acceptable.** When the ambient temperature changes 1°C, the pressure also changes approximately 0.01 MPa. The pressure, if changed, should be compensated for.
 - e) If a pressure drop is observed in checking e) and a) – d), a leak exists somewhere. Find a leak by applying bubble test liquid to welded parts and flare joints and repair it. After repair, conduct an air-tightness test again.
- ④ Always pull air from the pipes after the airtightness test.

CAUTION
Applying excessive pressure can cause an inflow of nitrogen gas into an outdoor unit.

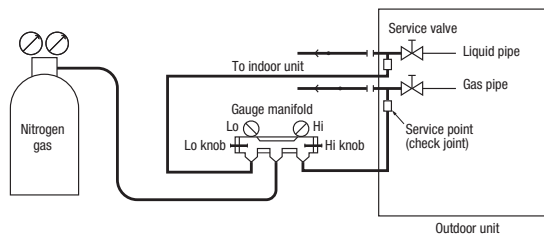

Standard torque at sections on service valve

Service valve size (mm)	Shaft tightening torque (N·m)	Cap tightening torque (N·m)	Check joint blind nut tightening torque (N·m)
Ø9.52 (3/8")	6-8	20-30	10-12
Ø12.7 (1/2")	14-16	25-35	10-12
Ø19.05 (3/4")	3	30-35	12-14

Securely tighten the cap and the blind nut after the adjustment. Avoid applying any excessive force when operating the shaft or when tightening the cap or blind nut. Otherwise, it could cause malfunction or leakage from the shaft, cap or blind nut.

▶ Allen wrench type

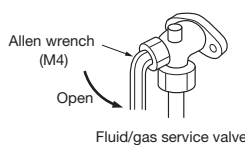

- Open the valve stem till it hits the stopper. No need to apply force more than that.
- After the adjustment, replace the blind nut as it was.

▶ Pin type

Remove the cap and adjust as shown below

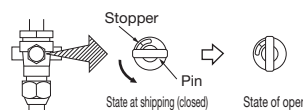

- After the adjustment, replace the cap as it was.

(2) Air purge

Perform the air purge from both the check joints at fluid side and gas side.

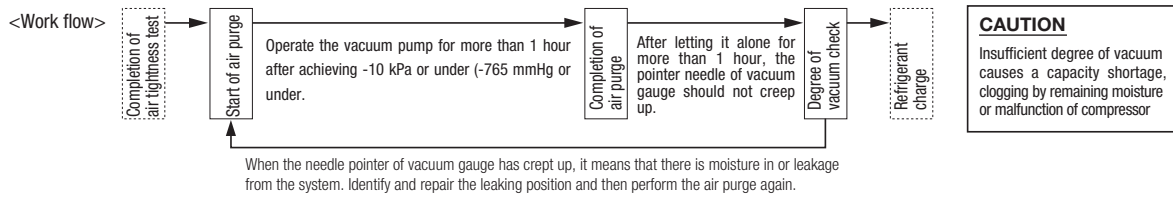

When the needle pointer of vacuum gauge has crept up, it means that there is moisture in or leakage from the system. Identify and repair the leaking position and then perform the air purge again.

This product uses R410A. Take care of the following points.

- To avoid contamination with different type of oil, use separate tools depending on the type of refrigerant. It is prohibited especially to use the gauge manifold and the charge hose for different types of refrigerant (R22, R407C).
- Use a reverse flow prevention adaptor to prevent the contamination of refrigerant system with vacuum pump oil.

4-4. Additional charge of refrigerant

- Refrigerant must be in the state of fluid when charging.
- Make sure to use a measuring device when charging the refrigerant.
- When it cannot charge whole required quantity because the outdoor unit is stopped, operate the unit in the test run mode and charge. (See Section 8 for the method of test run.) Operating the unit for a long period of time with insufficient quantity of refrigerant could cause malfunction on the compressor. (When charging while operating the unit, especially, complete the charge within 30 minutes.) This unit contains 11.5 kg of refrigerant. Calculate necessary quantity of additional charge with the following formula, and record the quantity of additionally charged refrigerant on the refrigerant quantity list provided on the back of service panel.
- Charge the additional refrigerant depending on the size and length of fluid pipe. Determine the quantity of additional charge by rounding the second place after decimal point, which means in the unit of 0.1 kg.

$$\text{Additional charge quantity (kg)} = 2.5 + (L3 \times 0.17) + (L4 \times 0.11) + (L5 \times 0.054) + (L6 \times 0.022)$$

Standard additional refrigerant quantity Charge quantity for the refrigerant piping

Make sure to charge this quantity in addition to the charge quantity for the refrigerant piping.

L3: Tot al length of ø15.88 pipes (m), L4: Total length of ø12.7 pipes (m)
L5: Total length of ø9.52 pipes (m), L6: Total length of ø6.35 pipes (m)

Refrigerant pipe size	ø15.88	ø12.7	ø9.52	ø6.35	Remark
Additional charge quantity(kg/m)	0.17	0.11	0.054	0.022	

- This product uses R410A. Take care of the following points.

- To avoid contamination with different type of oil, use separate tools depending on the type of refrigerant. It is prohibited especially to use the gauge manifold and the charge hose for different types of refrigerant (R22, R407C).
- Type of refrigerant is indicated with the color painted on the container (Yellow for R140A). Sufficient care must be taken to use correct refrigerant only.
- Never use a charge cylinder. Otherwise, the composition of refrigerant may change when introducing R410A into the cylinder.
- Make sure to charge the refrigerant in the state of fluid.

● Request

Record the refrigerant quantity calculated based on the piping length in the refrigerant quantity list provided on the back of service panel.

THE LABEL FOR THE QUANTITY OF REFRIGERANT

1. The unit has been charged with 11.5 kg of refrigerant.

2. Enter the length of each pipe for each size in the table column. Charge the additional refrigerant in the quantity of the above additional refrigerant quantity. Also, fill the additional charge quantity for the refrigerant pipe, which is indicated by each letter.

3. Total charge quantity of refrigerant (kg)

4. Total charge quantity of refrigerant (kg)

5. Total charge quantity of refrigerant (kg)

6. Total charge quantity of refrigerant (kg)

7. Total charge quantity of refrigerant (kg)

8. Total charge quantity of refrigerant (kg)

9. Total charge quantity of refrigerant (kg)

10. Total charge quantity of refrigerant (kg)

11. Total charge quantity of refrigerant (kg)

12. Total charge quantity of refrigerant (kg)

13. Total charge quantity of refrigerant (kg)

14. Total charge quantity of refrigerant (kg)

15. Total charge quantity of refrigerant (kg)

16. Total charge quantity of refrigerant (kg)

17. Total charge quantity of refrigerant (kg)

18. Total charge quantity of refrigerant (kg)

19. Total charge quantity of refrigerant (kg)

20. Total charge quantity of refrigerant (kg)

21. Total charge quantity of refrigerant (kg)

22. Total charge quantity of refrigerant (kg)

23. Total charge quantity of refrigerant (kg)

24. Total charge quantity of refrigerant (kg)

25. Total charge quantity of refrigerant (kg)

26. Total charge quantity of refrigerant (kg)

27. Total charge quantity of refrigerant (kg)

28. Total charge quantity of refrigerant (kg)

29. Total charge quantity of refrigerant (kg)

30. Total charge quantity of refrigerant (kg)

31. Total charge quantity of refrigerant (kg)

32. Total charge quantity of refrigerant (kg)

33. Total charge quantity of refrigerant (kg)

34. Total charge quantity of refrigerant (kg)

35. Total charge quantity of refrigerant (kg)

36. Total charge quantity of refrigerant (kg)

37. Total charge quantity of refrigerant (kg)

38. Total charge quantity of refrigerant (kg)

39. Total charge quantity of refrigerant (kg)

40. Total charge quantity of refrigerant (kg)

41. Total charge quantity of refrigerant (kg)

42. Total charge quantity of refrigerant (kg)

43. Total charge quantity of refrigerant (kg)

44. Total charge quantity of refrigerant (kg)

45. Total charge quantity of refrigerant (kg)

46. Total charge quantity of refrigerant (kg)

47. Total charge quantity of refrigerant (kg)

48. Total charge quantity of refrigerant (kg)

49. Total charge quantity of refrigerant (kg)

50. Total charge quantity of refrigerant (kg)

51. Total charge quantity of refrigerant (kg)

52. Total charge quantity of refrigerant (kg)

53. Total charge quantity of refrigerant (kg)

54. Total charge quantity of refrigerant (kg)

55. Total charge quantity of refrigerant (kg)

56. Total charge quantity of refrigerant (kg)

57. Total charge quantity of refrigerant (kg)

58. Total charge quantity of refrigerant (kg)

59. Total charge quantity of refrigerant (kg)

60. Total charge quantity of refrigerant (kg)

61. Total charge quantity of refrigerant (kg)

62. Total charge quantity of refrigerant (kg)

63. Total charge quantity of refrigerant (kg)

64. Total charge quantity of refrigerant (kg)

65. Total charge quantity of refrigerant (kg)

66. Total charge quantity of refrigerant (kg)

67. Total charge quantity of refrigerant (kg)

68. Total charge quantity of refrigerant (kg)

69. Total charge quantity of refrigerant (kg)

70. Total charge quantity of refrigerant (kg)

71. Total charge quantity of refrigerant (kg)

72. Total charge quantity of refrigerant (kg)

73. Total charge quantity of refrigerant (kg)

74. Total charge quantity of refrigerant (kg)

75. Total charge quantity of refrigerant (kg)

76. Total charge quantity of refrigerant (kg)

77. Total charge quantity of refrigerant (kg)

78. Total charge quantity of refrigerant (kg)

79. Total charge quantity of refrigerant (kg)

80. Total charge quantity of refrigerant (kg)

81. Total charge quantity of refrigerant (kg)

82. Total charge quantity of refrigerant (kg)

83. Total charge quantity of refrigerant (kg)

84. Total charge quantity of refrigerant (kg)

85. Total charge quantity of refrigerant (kg)

86. Total charge quantity of refrigerant (kg)

87. Total charge quantity of refrigerant (kg)

88. Total charge quantity of refrigerant (kg)

89. Total charge quantity of refrigerant (kg)

90. Total charge quantity of refrigerant (kg)

91. Total charge quantity of refrigerant (kg)

92. Total charge quantity of refrigerant (kg)

93. Total charge quantity of refrigerant (kg)

94. Total charge quantity of refrigerant (kg)

95. Total charge quantity of refrigerant (kg)

96. Total charge quantity of refrigerant (kg)

97. Total charge quantity of refrigerant (kg)

98. Total charge quantity of refrigerant (kg)

99. Total charge quantity of refrigerant (kg)

100. Total charge quantity of refrigerant (kg)

CAUTION
Make sure to enter the data. The data is required at maintenance or service.

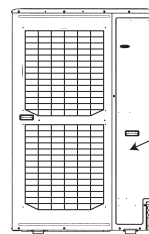

Attached on the back of service panel.

4-5. Heat insulation and moisture condensation proof

- (1) Dress refrigerant pipes (both gas and liquid pipes) for heat insulation and prevention of dew condensation. Improper heat insulation/anti-dew dressing can result in a water leak or dripping causing damage to household effects, etc.
 - (2) Use a heat insulating material that can withstand 120°C or a higher temperature. Poor heat insulating capacity can cause heat insulation problems or cable deterioration.
- All gas pipes must be securely heat insulated in order to prevent damage from dripping water that comes from the condensation formed on them during a cooling operation or personal injury from burns because their surface can reach quite a high temperature due to discharged gas flowing inside during a heating operation.
 - Wrap indoor units' flare joints with heat insulating parts (pipe cover) for heat insulation (both gas and liquid pipes).
 - Give heat insulation to both gas and liquid side pipes. Bundle a heat insulating material and a pipe tightly together so that no gaps may be left between them and wrap them together with a connecting cable by a dressing tape.
 - Although it is verified in a test that this air-conditioning unit shows satisfactory performance under JIS condensation test conditions, both gas and liquid pipes need to be dressed with 20mm, or over, heat insulation materials additionally above the ceiling where relative humidity exceeds 70%.

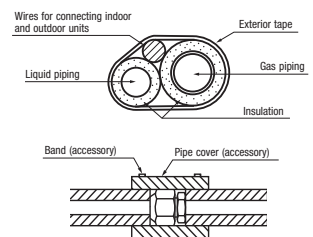

5. Drainage

- Where water drained from the outdoor unit may freeze, connect the drain pipe using optional drain elbow and drain grommet.
- Outdoor unit has 4 drain outlets on the bottom.
- When guiding drain water to a scupper, etc, install the parts on a flat stand (option item), blocks, or other.
- Connect the drain elbow as shown by the figure. Seal remaining holes with grommets.
- When draining water collectively, use holes for wires and pipes opened other than on the bottom. When this is impracticable, sufficiently seal the drain pipe to prevent water leakage.

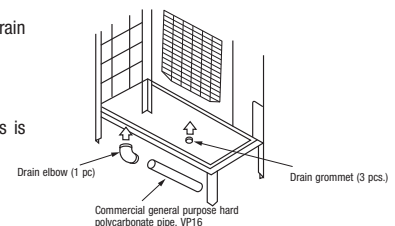

6. Electric wiring

Electrical installation work must be performed by an electrical installation service provider qualified by a power provider of the country. Electrical installation work must be executed according to the technical standards and other regulations applicable to electrical installations in the country.

⚠ Please install an earth leakage breaker without fail. The installation of an earth leakage breaker is compulsory in order to prevent electric shocks or fire accidents. (Since this unit employs inverter control, please **use an impulse withstanding type** to prevent an earth leakage breaker's false actuation.)

Please note

- Use only copper wires.
Do not use any supply cord lighter than one specified in parentheses for each type below.
 - braided cord (code designation 60245 IEC 51), if allowed in the relevant part 2;
 - ordinary tough rubber sheathed cord (code designation 60245 IEC 53);
 - flat twin tinsel cord (code designation 60227 IEC 41)
 - ordinary polyvinyl chloride sheathed cord (code designation 60227 IEC 53).
- Please do not use anything lighter than polychloroprene sheathed flexible cord (cord designation 60245 IEC57) for supply cords of parts of appliances for outdoor use.
- Use separate power source for the indoor and outdoor units.**
- The power source for indoor units in the same system should turn on and off simultaneously.**
- Ground the unit. Do not connect the grounding wire to a gas pipe, water pipe, lightning rod or telephone grounding wire. A grounding wire must be connected before connecting the power cable. Provide a grounding wire longer than the power cable. If improperly grounded, an electric shock or malfunction may result.
- The installation of an impulse with standing type earth leakage breaker is necessary.** A failure to install an earth leakage breaker can result in an accident such as an electric shock or a fire. Do not turn on the power until the electrical work is completed. Be sure to turn off the power when servicing.
- Please do not use a condensive capacitor for power factor improvement under any circumstances. (It does not improve power factor, while it can cause an abnormal overheat accident.)
- For power source cables, use conduits.
- Make sure do not lay electronic control cables (remote control and signaling lines) and other high current cables together outside the unit.** Laying them together can result in malfunctioning or a failure of the unit due to electric noises.
- Power cables and signaling lines must always be connected to the terminal block and secured by cable fastening clamps provided in the unit.
- Fasten cables so that they may not touch the piping, etc.
- When cables are connected, please make sure that all electrical components within the electrical component box are not free or not loose on the terminal connection** and then attach the cover securely. (Improper cover attachment can result in malfunctioning or a failure of the unit, if water penetrates into the box.)
- Make sure to use circuit breakers (earth leakage breaker and circuit breaker) of proper capacity. Use of breakers of larger capacity could result in trouble on components or fire accident. The circuit breaker should isolate all poles under over current.
- Install isolator or disconnect switch on the power source wiring in accordance with the local codes and regulations. The isolator should be locked in OFF state in accordance with EN60204-1.
- After maintenance, all wiring, wiring ties and the like, should be returned to their original state and wiring route, and the necessary clearance from all metal parts should be secured.

6-1. Wiring system drawing

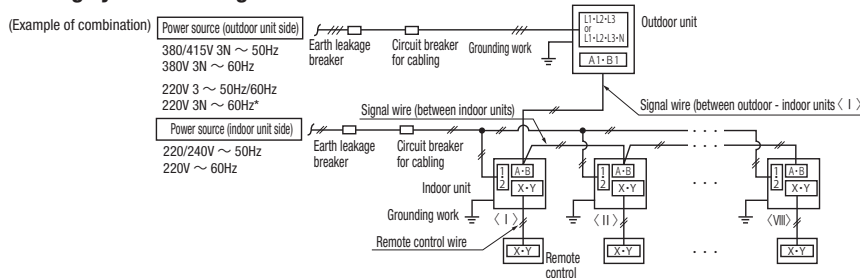

*Do not connect N-phase wire to the unit when the power source is 3-phase and 4-wire.

CAUTION

If the earth leakage breaker is exclusively for ground fault protection, then you will need to install a circuit breaker for wiring work.

6-2. Power source connection

(1) Method of leading out cables

- As shown on the drawing in Section 4-2, cables can be laid through the front, right, left or bottom casing.
- In wiring on the installation site, cut off a half-blank covering a penetration of the casing with nippers.
- In the case of an installation using a collective drain system, use a port other than the bottom one to take out cables and pipes. If the bottom port is used, seal it thoroughly so that drain water may not spill out.

(2) Notabilia in connecting power cables

- Connect the ground wire before you connect the power cable. When you connect a grounding wire to a terminal block, use a grounding wire longer than the power cable so that it may not be subject to tension.
- Do not turn on power until installation work is completed. Turn off power to the unit before you service the unit.
- Ensure that the unit is properly grounded.
- Always connect power cables to the power terminal block.
- To connect a cable to the power terminal block, use a round crimp contact terminal.
- If two cables are to be connected to one terminal, arrange cables in such a manner that you put their crimp contact terminals together back to back. Further, put the thinner cable above the thicker one in arranging cables for such connection.
- Use specified wires in wiring, and fasten them securely in such a manner that the terminal blocks are not subject to external force.
- In fastening a screw of a terminal block, use a correct-size driver.
- Fastening a screw of a terminal block with excessive force can break the screw.
- When electrical installation work is completed, make sure that all electrical components within the electrical component box are free of loose connector coupling or terminal connection.

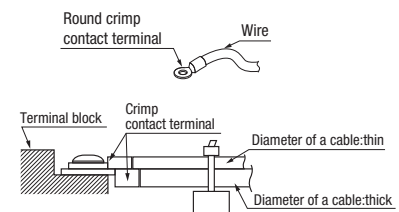

(3) Outdoor unit power source specification: 380/415V 3N~ 50Hz 380V 3N~ 60Hz 220V 3~ 60Hz

Model	Power source	Cable size for power source (mm ²)	Wire length (m)	Moulded-case circuit breaker (A)		Earth leakage breaker	Earth wire	
				Rated current	Switch capacity		Size (mm ²)	Screw type
224KXZME1 280KXZME1	Three-phase 380/415V 50Hz 380V 60Hz	5.5	54	30	30	30A, 30mA less than 0.1 sec	2	M5
335KXZME1								

Please note

- The method of laying cables has been determined pursuant to the Japanese indoor wiring regulations (JEC8001). (Please adapt it to the regulations in effect in each country.)
- For details, please refer to the installation manual supplied with the indoor unit.

6-3. How to connect signal cables

The communication protocol can be chosen from following two types. One of them is the conventional Superlink (hereinafter previous SL) and the other is the new Superlink II (hereinafter new SL). These two communication protocols have the following advantages and restrictions, so please choose a desirable one meeting your installation conditions such as connected indoor units and central control. When signal cables are connected into a network involving outdoor units, indoor units or central control equipment that do not support new SL, please select communications in the previous SL mode, even if the refrigerant system is separated from theirs.

Communication protocol	Conventional communication protocol (previous SL)	New communication protocol (new SL)
Outdoor unit setting (SW5-5)	ON	OFF (Factory default)
No. of connectable indoor units	Max. 48	Max. 128
No. of connectable outdoor units in a network	Max. 48	Max. 32
No. of connectable outdoor units	Up to 1000m	Up to 2,000 m for wires other than shielding wire Up to 1,500 m for 0.75 mm ² shielding wire (MWVS) Up to 1,000 m for 1.25 mm ² shielding wire (MWVS)
Signal cable (furthest length)	Up to 1000m	Up to 1000m
Connectable units to a network	Units not supporting new SL (FD○A△△KXE4.5 series) Units supporting new SL (FD○A△△KXE6 series, FD○A△△KXZ series) Can be used together.	Units supporting new SL (FD○A△△KXE6 series, FD○A△△KXZ series)

Note: For FDT224 and 280 models, calculate the number of units taking 1 indoor unit as 2 units for the sake of communication.

● **Signal cables are for DC 5 V. Never connect wires for 220/240 V or 380/415 V.** Protective fuse on the PCB will trip.

- ① Confirm that signal cables are prevented from applying 220/240 V or 380/415 V
- ② Before turning the power on, check the resistance on the signal cable terminal block. If it is less than 100Ω, power source cables may be connected to the signal cable terminal block.

When units of FD○A△△KXE6 Series, FD○A△△KXZE1 series are connected:

Standard resistance value=5,100/Number of connected units.

When units of FD○A△△KXE4 and 5 Series only are connected:

Standard resistance value=9,200/Number of connected units.

When units of FD○A△△KXE6 Series, FD○A△△KXZE1 series and units of FD○A△△KXE4 and 5 Series are connected in a mixture:

Standard resistance value=46,000/[(Number of connected FD○A△△KXE4 and 5 Series units x 5) + (Number of connected FD○A△△KXE6 and KXZ Series units x 9)]

The number of connected units includes those of indoor units, outdoor units and SL devices..

If the resistance value is less than 100Ω, disconnect the signal cables temporarily to divide to more than one network, to reduce the number of indoor units on the same network, and check each network.

Indoor and outdoor units signal cables

- Connect the signal line between indoor unit and outdoor unit to A1 and B1.
- Connect the signal line between outdoor units to A2 and B2.
- Please use a shielded cable for a signal line and connect a shielding earth at all the indoor units and outdoor units.

(1) When one outdoor unit is used.

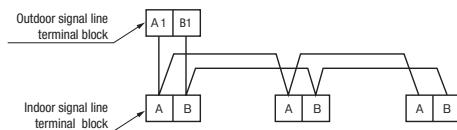

- Indoor and outdoor signal lines do not have a polarity.
- Any of the connections in the following illustration can be made.

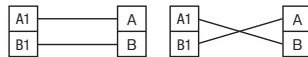

(1) The signal lines can also be connected using the method shown below.

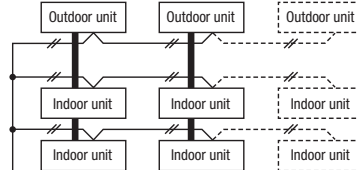

(2) When plural outdoor units are used

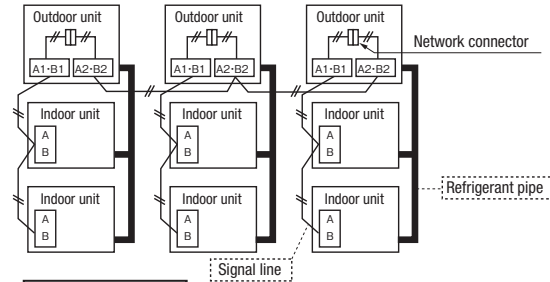

Important ○ Loop wiring prohibited.

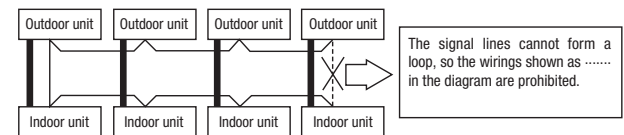

Power cable and signal cable connection

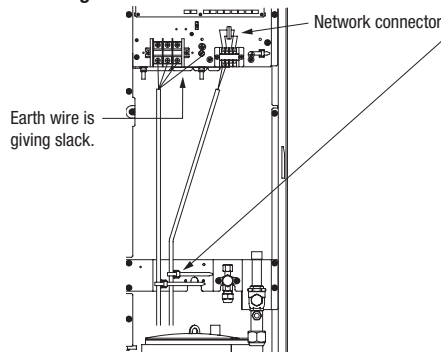

Wiring clamp

- Fix the cables not to exert external force to the terminal connection.
- Give adequate slack to cables in fastening them.
- Fix power cables separately from signal cables.

Outgoing cable direction

- As like the refrigerant pipe, it can be let out in any of 4 directions of right-hand side, front, rear and bottom.

Wiring label

- The wiring label is attached on the back of the service panel.

Request

- When connecting to the power source terminal block, use the crimp terminals for M5 as shown at right.
- When connecting to the signal terminal block, use the crimp terminals for M3.5 as shown at right.

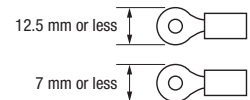

Remote control wiring specifications

- For the remote control the standard wire is 0.3 mm². The max. length is up to 600 m. When the wire is more than 100 m long, use the wire shown in the table.
- Use 3-core wires for FD○A△△KXE4 or 2-core wires for FD○A△△KXE6.

Length (m)	Wire size
Within 100 - 200	0.5m ²
Within - 300	0.75m ²
Within - 400	1.25m ²
Within - 600	2.0m ²

7. CONTROL SETTINGS

7-1. Unit address setting

This control system controls the controls of more than one air-conditioner's outdoor unit, indoor unit and remote control unit through communication control, using the microcomputers built in the respective controls. Address setting needs to be done for both outdoor and indoor units. Turn on power in the order of the outdoor units and then the indoor units.

Use 1 minute as the rule of thumb for an interval between them.

The communication protocol can be chosen from following two types. One of them is the conventional communication protocol (previous SL) and the other is the new communication protocol (new SL). These two communication protocols have their own features and restrictions as shown by Table 6-3. Select them according to the indoor units and the central control to be connected.

When signal cables are connected into a network involving outdoor units, indoor units or central control equipment that do not support new SL, please select communications in the previous SL mode, even if the refrigerant system is separated from theirs.

When communication is established after setting addresses, check the communication protocol with the 7-segment display panel of the outdoor unit.

●Address setting methods

The following address setting methods can be used. The procedure for automatic address setting is different from the conventional one. Please use the automatic address setting function after reading this manual carefully.

Communication protocol Address setting method		new SL		previous SL	
		Automatic	Manual	Automatic	Manual
When plural refrigerant systems are linked with signal lines (e.g., to implement central control)	Case 1 When signal lines linking plural refrigerant systems are provided between outdoor units. (When the network connector is disconnected, refrigerant systems are separated each other)	OK*1	OK	×	OK
	Case 2 When signal lines linking plural refrigerant systems are provided between indoor units.	×	OK	×	OK
When only one refrigerant system is involved (signal lines do not link plural refrigerant systems)		OK	OK	OK	OK

※1 Do not connect the signal line between outdoor units to A1 and B1. This may interrupt proper address setting. (Case 3)

Do not connect the signal line between indoor unit and outdoor unit to A2 and B2. This may interrupt proper address setting. (Case 4)

※2 In Case 2, automatic address setting is not available. Set addresses manually.

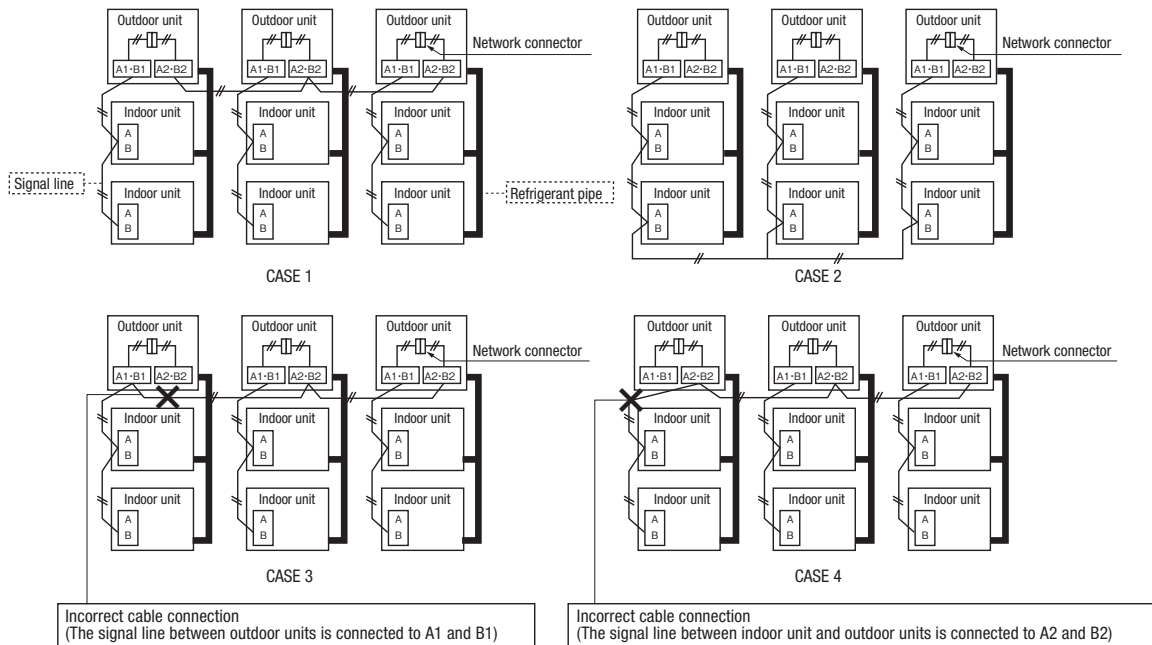

●Address No. setting

Set SW1 through 4 and SW5-2 provided on the PCB and SW1 & 2 provided on the outdoor unit PCB as shown in the drawings below.

Indoor PCB	SW1, 2 (blue)	For setting indoor No. (The ten's and one's)
	SW3, 4 (green)	For setting outdoor No. (The ten's and one's)
	SW5-2	Indoor No. switch (The hundred's Place) [OFF : 0, ON : 1]
Outdoor PCB	SW1, 2 (green)	For setting outdoor No. (The ten's and one's)

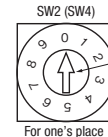
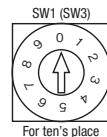

By inserting a flat driver (precision screwdriver) into this groove and turn the arrow to point a desired number.

●Summary of address setting methods (figures in [] should be used with previous SL)

	Units supporting new SL			Units NOT supporting new SL		
	Indoor unit address setting		Outdoor unit address setting	Indoor unit address setting		Outdoor unit address setting
	Indoor No. switch	Outdoor No. switch	Outdoor No. switch	Indoor No. switch	Outdoor No. switch	Outdoor No. switch
Manual address setting (previous SL/new SL)	000-127[47]	00-31[47]	00-31[47]	00-47	00-47	00-47
Automatic address setting for single refrigerant system installation (previous SL/new SL)	000	49	49	49	49	49
Automatic address setting for multiple refrigerant systems installation (with new SL only)	000	49	00-31	×	×	×

Do not set numbers other than those shown in the table, or an error may be generated.

Note: When units supporting new SL are added to a network using previous SL such as one involving FDO/A/△/KXE4 series units, choose previous SL for the communication protocol and set addresses manually. Since the models FDT224 and 280 have 2 PCBs per unit, set different indoor unit No. and SW on each PCB.

- An outdoor unit No., which is used to identify which outdoor unit and indoor units are connected in a refrigerant system, is set on outdoor unit PCB and indoor unit PCB. Give the same outdoor unit No. to all outdoor unit and indoor units connected in same refrigerant system.
- An indoor unit No. is used to identify individual indoor units. Assign a unique number that is not assigned to any other indoor units on the network.

Unless stated otherwise, the following procedures apply, when new SL is chosen for the communication protocol.
When previous SL is chosen, use figures shown in [] in carrying out these procedures.

Manual address setting Generally applicable to new SL/previous SL, use figures in [] with previous SL.

- ① Outdoor unit address setting
Set as follows before you turn on power. Upon turning on power, the outdoor unit address is registered.
Set the **Outdoor Unit No. switch to a number 00 - 31 [in the case of previous SL: 00 - 47]**.
Set a unique number by avoiding the numbers assigned to other outdoor units on the network.
- ② Indoor unit address setting
Set as follows before you turn on power. Upon turning on power, the indoor unit address is registered.
Set the **Indoor Unit No. switch to a number 000 - 127 [in the case of previous SL: 00 - 47]**.
Set the **Outdoor Unit No. switch** to the outdoor unit No. of the associated outdoor unit within the range of **00 - 31 [in the case of previous SL: 00 - 47]**.
Set a unique number by avoiding the numbers assigned to other indoor units on the network.
- ③ Turn on power in order from the outdoor unit to indoor units. Give a one-minute or longer interval for them.
* When there are some units not supporting new SL connected in the network, set SW5-5 to ON to choose the previous SL communication mode.
In the case of previous SL, the maximum number of indoor units connectable in a network is 48.

Automatic address setting Generally applicable to new SL/previous SL, use figures in [] with previous SL.

With new SL, you can set indoor unit addresses automatically even for an installation involving multiple refrigerant systems connected with same network, in addition to the conventional automatic address setting of a single refrigerant system installation.

However, an installation must satisfy some additional requirements such as for wiring methods, so please read this manual carefully before you carry out automatic address setting.

(1) In the case of a single refrigerant system installation (Generally applicable to new SL/previous SL, use figures in [] with previous SL.)

- ① Outdoor unit address setting
Set as follows before you turn on power.
Make sure that the **Outdoor Unit No. switch** is set to **49 (factory setting)**
- ② Indoor unit address setting
Set as follows before you turn on power.
Make sure that the **Indoor Unit No. switch** is set to **000 [in the case of previous SL: 49] (factory setting)**
Make sure that the **Outdoor Unit No. switch** is set to **49 (factory setting)**
- ③ Turn on power in order from the outdoor unit to indoor units. Give a one-minute or longer interval for them. Unlike the procedure set out in (2) below, you need not change settings from the 7-segment display panel.
- ④ Make sure that the number of indoor units indicated on the 7-segment display panel agrees with the number of the indoor units that are actually connected to the refrigerant system.

(2) In the case of a multiple refrigerant systems installation (Applicable to new SL only. In the case of previous SL, set addresses with some other method.)

(This option is available when the interconnection wiring among refrigerant systems is on the outdoor side and new SL is chosen as the communication protocol.)

Address setting procedure (perform these steps for each outdoor unit)

[STEP1] (Items set before turning on power)

- ① Outdoor unit address setting
Set as follows before you turn on power.
Set the **Outdoor Unit No. switch** to a number **00 - 31**. Set a unique number by avoiding the numbers assigned to other outdoor units on the network.
- ② Indoor unit address setting
Set as follows before you turn on power.
Make sure that the **Indoor Unit No. switch** is set to **000 (factory setting)**
Make sure that the **Outdoor Unit No. switch** is set to **49 (factory setting)**
- ③ Isolate the present refrigerant system from the network.
Disengage the **network connectors (white 2P)** of the outdoor units. (Turning on power without isolating each refrigerant system will result in erroneous address setting.)

[STEP2] (Power on and automatic address setting)

- ④ Turn on power to the outdoor unit
Turn on power in order from the outdoor unit to indoor units. Give a one-minute or longer interval for them.
- ⑤ Select and enter "1" in P31 in the 7-segment display panel of each outdoor unit to input "Automatic address start."
- ⑥ Input a starting address and the number of connected indoor units.
Input a starting address in P32 on the 7-segment display panel of each outdoor unit.
- ⑦ When a starting address is entered, the display indication will switch back to the "Number of Connected Indoor Units Input" screen.
Input the number of connected indoor units from the 7-segment display panel of each outdoor unit. Please input the number of connected indoor units for each outdoor unit. (You can input it from P33 on the 7-segment display panel.) When the number of connected indoor units is entered, the 7-segment display panel indication will switch to "AUX" and start flickering.

[STEP3] (Automatic address setting completion check)

- ⑧ Indoor unit address determination
When the indoor unit addresses are all set, the 7-segment display panel indication will switch to "AUE" and start flickering.
If an error is detected in this process, the display will show "A○○."
Check the 7-segment display panel of each outdoor unit.
Depending on the number of connected indoor units, it may take **about 10 minutes** before the indoor unit addresses are all set.

[STEP4] (Network definition setting)

- ⑨ Network connection
When you have confirmed an "AUE" indication on the display of each outdoor unit, **engage the network connectors** again.
- ⑩ Network polarity setting
After you have made sure that the network connectors are engaged in ⑧, select and enter "1" in P34 on the 7-segment display panel of **any outdoor unit (on only 1 unit)** to specify network polarity.
- ⑪ Network setting completion check
When the network is defined, "End" will appear on the 7-segment display panel. An "End" indication will go off, when some operation is made from the 7-segment display panel or 3 minutes after.

	STEP1	STEP2	STEP3	STEP4
Indoor unit power source	② OFF	④ ON	—	—
Outdoor unit power source	① OFF	④ ON	—	—
Indoor unit (indoor/outdoor No.switch)	② indoor000/outdoor 49 (factory setting)	—	—	—
Outdoor unit (outdoor No.switch)	① 01,02(Ex)	—	—	—
Network connectors	③ Disconnect(each outdoor unit)	—	—	⑨ Connect(each outdoor unit)
Start automatic address setting	—	⑤ Select "Automatic Address Start" on each outdoor unit.	—	—
Set starting address	—	⑥ outdoor 01:[01](Ex) outdoor 02:[04](Ex)	—	—
Set the number of indoor unit	—	⑦ outdoor 01:[03](Ex) outdoor 02:[03](Ex)	—	—
Polarity setting	—	—	—	⑩ Set in P34 on the 7-segment display panel of any outdoor unit.
7-segment display	—	⑦ [AUX] (Blink)	⑧ "AUE"(blink), or "A○○" in error events.	⑪ [End]

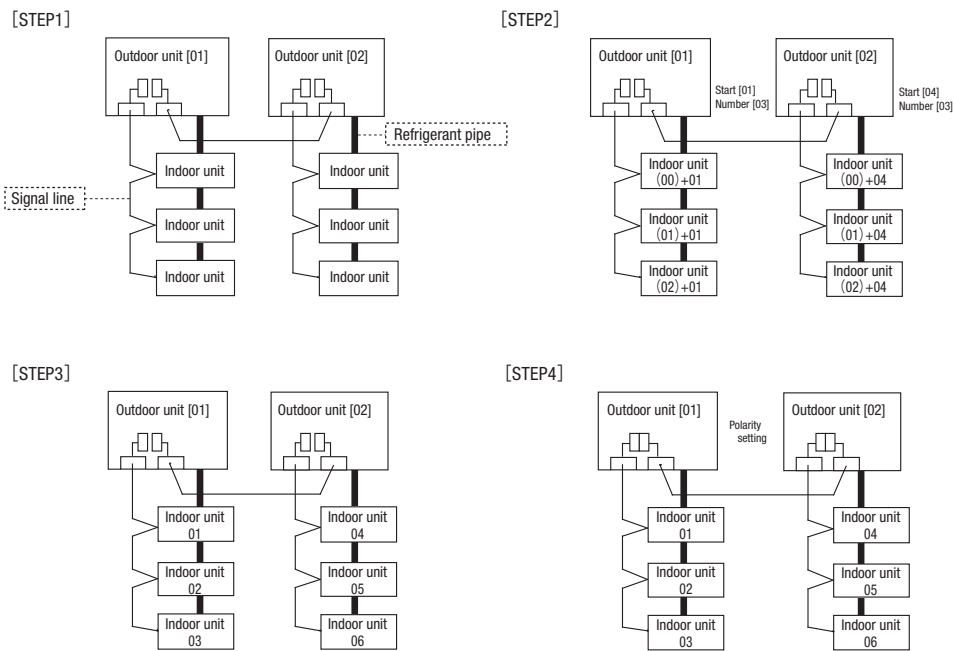

- Within a refrigerant system, indoor units are assigned addresses in the order they are recognized by the outdoor unit. Therefore, they are not necessarily assigned addresses in order from the nearest to the outdoor unit first as depicted in drawings above.
- Make sure that power has been turned on to all indoor units.
- When addresses are set, you can have the registered indoor unit address No.'s and the outdoor unit address No. displayed on the remote control unit by pressing its Inspection switch.
- Automatic address setting can be used for an installation in which plural indoor units are controlled from one remote control unit.
- Once they are registered, addresses are stored in microcomputers, even if power is turned off.
- If you want to change an address after automatic address setting, you can change it from the remote control unit with its "Address Change" function or by means of manual setting. Set a unique address by avoiding the address assigned to other indoor unit on the network when the address is changed.
- Do not turn on power to central control equipment until automatic address setting is completed.
- When addresses are set, be sure to perform a test run and ensure that you can operate all indoor and outdoor units normally. Also check the addresses assigned to the indoor units.

Address change (available only with new SL)











"Address Change" is used, **when you want to change an indoor unit address assigned with the "Automatic Address Setting" function from a remote control unit.** Accordingly, the conditions that permit an address change from a remote control unit are as follows.

	Indoor unit address setting		Outdoor unit address setting
	Indoor No.switch	Outdoor No.switch	Outdoor No.switch
Automatic address setting for single refrigerant system installation	000	49	49
Automatic address setting for multiple refrigerant systems installation	000	49	00-31

If "CHANGE ADD. ▼" is selected with some addresses falling outside these conditions, the following indication will appear for 3 seconds on the remote control "INVALID OPER".



















Operating procedure

(1) When single indoor unit is connected to the remote control.

Item	Operation	Display
1 Address change mode	① Press the AIR CON No. switch for 3 seconds or longer.	[CHANGE ADD.▼]
	② Each time when you press the  switch, the display indication will be switched.	[CHANGE ADD.▼] ⇔[MASTER I/U▲]
	③ Press the Set switch when the display shows "CHANGE ADD. ▼" and then start the address change mode, changing the display indication to the "Indoor Unit No. Setting" screen from the currently assigned address.	[I/U 001 O/U 01] (1sec) →[ SET I/U ADD.] (1sec) →[I/U 001 ] (Blink)
2 To set a new indoor unit No.	④ Set a new indoor unit No. with the  switch. A number indicated on the display will increase or decrease by 1 upon pressing the ▲ or ▼ switch respectively.	[I/U 000▲] ⇔[I/U 001 ] ⇔[I/U 002 ] ⇔ . . . ⇔[I/U 127▼]
	⑤ After selecting an address, press the Set switch, and then the indoor unit address No. is defined.	[I/U 002] (2sec)
3 To set a new outdoor unit No.	⑥ After showing the defined indoor address No. for 2 seconds, the display will change to the "Outdoor Address No. Setting" screen. The currently assigned address is shown as a default value.	[I/U 002] (2sec Lighting) →[ SET O/U ADD.] (1sec) →[O/U 01 ] (Blink)
	⑦ Set a new outdoor unit No. with the  switch. A number indicated on the display will increase or decrease by 1 upon pressing the ▲ or ▼ switch respectively.	[O/U 00▲] ⇔[O/U 01 ] ⇔[O/U 02 ] ⇔ . . . ⇔[O/U 31▼]
	⑧ After selecting an address, press the Set switch, and then the outdoor unit No. and the indoor unit No. are defined.	[I/U 002 O/U 02] (2sec Lighting) →[SET COMPLETE] (2sec Lighting) →Returns to normal condition.

(2) When plural indoor units are connected to the remote control.

When plural indoor units are connected, you can change their addresses without altering their cable connection.

Item	Operation	Display
1 Address change mode	① Press the AIR CON Unit No. switch for 3 seconds or longer.	[CHANGE ADD▼]
	② Each time when you press the  switch, the display indication will be switched.	[CHANGE ADD▼] ⇔[MASTER I/U▲]
	③ Press the Set switch when the display shows "CHANGE ADD. ▼" The lowest indoor unit No. among the indoor units connected to the remote control unit will be shown.	[ SELECT I/U] (1sec) →[I/U 001 O/U 01▲] (Blink)
2 Selecting an indoor unit to be changed address	④ Pressing the  switch will change the display indication cyclically to show the unit No.'s of the indoor units connected to the remote control and the unit No.'s of the outdoor units connected with them.	[I/U 001 O/U 01▲] ⇔[I/U 002 O/U 01 ] ⇔[I/U 003 O/U 01 ] ⇔ . . . ⇔[I/U 016 O/U 01▼]
	⑤ Then the address No. of the indoor unit to be changed is determined and the screen switches to the display "  SET I/U ADD."	[ SET I/U ADD.] (1sec) →[I/U 001 ] (Blink)
3 Setting a new indoor unit No.	⑥ Set a new indoor unit No. with the  switch. A number indicated on the display will increase or decrease by 1 upon pressing the ▲ or ▼ switch respectively.	[I/U 000▲] ⇔[I/U 001 ] ⇔[I/U 002 ] ⇔ . . . ⇔[I/U 127▼]
	⑦ After selecting an address, press the Set switch. Then the address No. of the indoor unit is determined.	[I/U 002] (2sec)
4 Setting a new outdoor unit No.	⑧ The display will indicate the determined indoor address No. for 2 seconds and then switch to the "  SET O/U ADD." screen. A default value shown on the display is the current address.	[I/U 002] (2sec lighting) ⇔ [ SET O/U ADD.] (1sec) ⇔[O/U 01 ] (Blink)
	⑨ Set a new outdoor unit No. with the  switch. A number indicated on the display will increase or decrease by 1 upon pressing the ▲ or ▼ switch respectively.	[O/U 00▲] ⇔[O/U 01 ] ⇔[O/U 02 ] ⇔ . . . ⇔[O/U 31▼]
	⑩ After selecting an address, press the Set switch. Then the address of the indoor unit and outdoor unit are determined.	[I/U 002 O/U 02] (2sec lighting) → [ SELECT] (1sec lighting) → [I/U SELECTION▼] (lighting)
	⑪ If you want to continue to change addresses, return to step ④.	[Press the  switch] (1sec) → [SET COMPLETE] (2-10sec lighting)
5 Ending the session	⑫ If you want to end the session (and reflect new address settings) In Step ⑩, press the ▼ switch to select "END ▲." If you have finished changing addresses, press the Set switch while "END ▲" is shown. While new settings are being transmitted, "SET COMPLETE" will be indicated. Then the remote control display will change to the normal state.	[END▲] → [SET COMPLETE] (2-10sec lighting) → Normal state
	⑬ If you want to end the session (without reflecting new address settings) Before you complete the present address setting session, press the "ON/OFF" switch. Then the display is change to exit from this mode and switch the display to the normal state. All address settings changed in the session will be aborted and not reflected.	[ON/OFF] → Forced termination

The  switch will continuously change the display indication to the next one in every 0.25 seconds when it is pressed for 0.75 seconds or longer.

If the Reset switch is pressed during an operation, the display indication returns to the one that was shown before the last Set switch operation.

Even if an indoor unit No. is changed in this mode, the registered indoor unit No. before address change mode is displayed when [I/U SELECTION▼] is shown.

When "SET COMPLETE" is shown, indoor unit No.'s are registered.

NOTICE Turn on power to central control equipment after the addresses are determined.
Turning on power in wrong order may result in a failure to recognize addresses.

● 7-segment display indication in automatic address setting

Items that are to be set by the customer

Code	Contents of a display
P30	Communication protocol 0: Previous SL mode 1: New SL mode (The communication protocol is displayed ; display only)
P31	Automatic address start
P32	Input starting address Specify a starting indoor unit address in automatic address setting.
P33	Input number of connected indoor units Specify the number of indoor units connected in the refrigerant system in automatic address setting.
P34	Polarity definition 0: Network polarity not defined. 1: Network polarity defined.

7-segment display indication in automatic address setting

Code	Contents of a display
AUX	During automatic address setting. X: The number of indoor units recognized by the outdoor unit.
AUE	Indoor unit address setting is completed normally.
End	Polarity is defined. (Automatic address) Completed normally.

Address setting failure indication

Code	Contents of a display	Please check
A00	Unable to find any indoor unit that can be actually communicated with.	Are signal lines connected properly without any loose connections? Is power for indoor units all turned on?
A01	The number of the indoor units that can be actually communicated with is less than the number specified in P33 on the 7-segment display panel.	Are signal lines connected properly without any loose connections? Input the number of connected indoor units again.
A02	The number of the indoor units that can be actually communicated with is more than the number specified in P33 on the 7-segment display panel.	Are signal lines connected properly without any loose connections? Are the network connectors coupled properly? Input the number of connected indoor units again.
A03	Starting address (P32) + Number of connected indoor units (P33) > 128	Input the starting address again. Input the number of connected indoor units again.
A04	While some units are operating in the previous SL mode on the network, the automatic address setting on multiple refrigerant systems is attempted.	Perform manual address setting. Separate old SL setting unit from the network Arrange all units to operate in the new SL.

Error indication

Code	Contents of a display	Cause
E2	Duplicating indoor unit address.	• Incorrect manual address setting
E3	Incorrect pairing of indoor-outdoor units.	• An outdoor unit number that does not exist in the network is specified • No master unit exists in combination outdoor unit.
E11	Address setting for plural remote controllers.	• Indoor unit address is set from plural remote controls.
E12	Incorrect address setting of indoor units.	• Automatic address setting and manual address setting are mixed.
E31	Duplicating outdoor unit address.	• Plural outdoor units are exist as same address in same network.
E46	Incorrect setting.	• Automatic address setting and manual address setting are mixed.

7-2. Selection switching

Controls of outdoor unit may be selected as follows using the dip switches on the PCB and P○○ on the 7-segment.

To change P○○ on the 7-segment, hold down SW8 (increasing a number shown on the 7-segment display panel: one's place), SW9 (increasing a number shown on the 7-segment display panel: tens place) and SW7 (Data write/Enter).

Control selecting method		P○○ on 7-segment	Content of control
SW setting on PCB		P○○ on 7-segment	
SW3-7 to ON=*1		Set external input function allocation to "2" *1	Forced cooling mode (It can be fixed at cooling with external input terminals open, or at heating with them short-circuited.)
SW5-1 to ON + SW5-2 to ON		—	Cooling test run
SW5-1 to ON + SW5-2 to OFF		—	Heating test run
Close the fluid operation valve on outdoor unit and set as follows: (1) SW5-2 on PCB to ON (2) SW5-3 on PCB to ON (3) SW5-1 on PCB to ON		—	Pump down operation
SW4-5:OFF, SW4-6:OFF*1	80% (Factory default)	Set allocation of external input function to "1" *1	Inputting signals to external input terminals selects the demand mode. (J13 short-circuited: Level input, J13 open: Pulse input)
SW4-5:ON, SW4-6:OFF*1	60%		
SW4-5:OFF, SW4-6:ON*1	40%		
SW4-5:ON, SW4-6:ON*1	00%		
SW5-5		—	Communication method selection ON: Previous SL communication, OFF: New SL communication
J13: Closed (Factory default), J13: Open		—	External input switing (CnS1, CnS2 only) Closed: Level input, Open: Pulse input
J14: Closed (Factory default), J14: Open			Defrost recover temperature Closed: normal, Open: cold weather district
J15: Closed (Factory default), J15: Open		—	Defrost start temperature Closed: normal, Open: cold weather district
—		P01	Operation priority selection 0: First push priority (at shipping) 1: Last push priority 2: Priority of master unit's setting operation mode 3: Priority of required major operation mode
—		P02	Outdoor unit fan snow protection control 0: Control disabled (at shipping) 1: Control enabled
—		P03	Outdoor unit fan snow protection control ON time setting - 30 sec (at shipping) 10, 30-600 sec
—		P04	Energy saving mode *2 OFF: Disabled (at shipping) 2 stage demand mode 000, 040, 060, 080 [%]
—		P05	Silencing mode setting 0 (at shipping) - 3: Larger values for larger effect
—		P06	Allocation of external output (CnZ1)
—		P07	Allocation of external input (CnS1)
—		P08	Allocation of external input (CnS2)
—		P09	Allocation of external input (CnG1)
—		P10	Allocation of external input (CnG2)
—		P11~	Spare

*1 Control is switched when both the allocation of external input function (P07-10) and SW are changed.

(Example: To use CnS1 for the input of forced cooling mode, set P07 at 2 and SW3-7 at ON. To use CnS2 for the input of forced cooling mode, set P08 at 2 and SW3-7 at ON.)

*2 In the energy saving mode, the capacity restriction becomes effective even if no signals are input at external input terminals.

By changing the allocation of external input functions (P07-19) on the 7-segment, functions of external input terminals may be selected. Inputting signals to external input terminals enable the following functions.

Setting value for allocation of external input function	With external input terminals closed	With external input terminals open
"0" : External operation input	Invalid	Valid
"1" : Demand input	Invalid	Valid
"2" : Cooling/heating forced input	Valid	Invalid
"3" : Silent mode 1 *1	Valid	Invalid
"4" : Spare		
"5" : Outdoor fan snow guard control input	Valid	Invalid
"6" : Test run external input 1 (equivalent to SW5-1)	Test run start	Normal
"7" : Test run external input 2 (equivalent to SW5-2)	Cooling	Heating
"8" : Silent mode 2 *2	Valid	Invalid
"9" : 2 stage demand input	Invalid	Valid

*1 Valid/invalid is changed depending on outdoor temperature.

*2 It is always Valid, regardless of outdoor temperature.

The external output function of CnZ1 can be changed by changing the setting in P06 on the 7-segment display panel.

"0" : Operation output
"1" : Error output
"2" : Compressor ON output
"3" : Fan ON output
"4 - 9" : Spare

7-3. External input and output terminals specifications

Name	Purpose (Factory default)	Specification	Operating side connector
External input CnS1	External operation input (Closed at shipping)	Non-voltage contactor (DC12V)	J.S.T (NACHIATSU) B02B-XAMK-1 (LF) (SN)
External input CnS2	Demand input (Closed at shipping)	Non-voltage contactor (DC12V)	J.S.T (NACHIATSU) B02B-XARK-1 (LF) (SN)
External input CnG1	Cooling/Heating forced input (Open at shipping)	Non-voltage contactor (DC12V)	J.S.T (NACHIATSU) B02B-XAEK-1 (LF) (SN)
External input CnG2	Silencing mode input (Open at shipping)	Non-voltage contactor (DC12V)	J.S.T (NACHIATSU) B02B-XASK-1 (LF) (SN)
External output CnZ1	Spare output (External output)	DC12V output	MOLEX 5566-02A-RE
External output CnH	Operation output	DC12V output	MOLEX 5566-02A-BU
External output CnY	Error output	DC12V output	MOLEX 5266-02A

8. TEST OPERATION AND TRANSFER

8-1. Before starting operation

- (1) **Make sure that a measurement between the power source terminal block and ground, when measured with a 500V megger tester, is greater than 1 MΩ.**
- (2) When the resistance of the signaling line terminal block is 100Ω or less before turning the power on, the power cables may be connected to the signaling line terminal block. Check the wiring referring to the standard resistance value of 6-3.
- (3) **Be sure turn ON the power source to supply power to the crank case heater 6 hours before operation.**
After supplying the power to the crank case heater, the compressor may not start unless the time mentioned above elapses. (For protection of compressor)
In such occasion, the 7-segment LED shows "dL○○○○". Wait till the temperature in the compressor rises sufficiently after turning power on to the crank case heater, before starting the test run.
- (4) **Make sure that the bottom of the compressor casing is warm.**
- (5) Be sure to fully open the service valves (liquid, gas) for the outdoor unit.
Operating the outdoor unit with the valves closed may damage the compressor.
- (6) **Confirm that the power is supplied to all indoor units. It could cause trouble if there is any indoor unit which is not powered.**

CAUTION

Please make sure that the service valves (gas, liquid) are full open before a test run. Conducting a test run with any of them in a closed position can result in a compressor failure.

8-2. Test run

(1) Test run from an outdoor unit.

Whether CnS1 is set to ON or OFF, you can start a test run by using the SW5-1 and SW5-2 switches provided on the outdoor unit PCB.

Select the test run mode first.

Please set SW5-2 to ON for a cooling test run or OFF for a heating test run. (It is set to OFF at the factory for shipment.)

Turning SW5-1 from OFF to ON next will cause all connected indoor units to start.

When a test run is completed, please set SW5-1 to OFF.

Note: During a test run, an indoor unit cannot be operated from the remote control unit (to change settings). ("Under central control" is indicated.)

(2) Method of starting a test run for a cooling operation from an outdoor unit: please operate a remote control unit according to the following steps.

(a) Start of a cooling test run

Operate the unit by pressing the [START/STOP] button.

Select the "COOLING" mode with the [MODE] button.

Press the [TEST RUN] button for 3 seconds or longer.

The screen display will be switched from "Select with ITEM ◆" → "Determine with [SET]" → "Cooling test run ▼."

When the [SET] button is pressed while "Cooling test run ▼" is displayed, a cooling test run will start. The screen display will be switched to "COOLING TEST RUN."

(b) Termination of a cooling test run

When the [START/STOP] button or the "TEMP SET [✓] [△]" button is pressed, a cooling test run will be terminated.

8-3. Transfer

- After completing the installation and test run, explain methods of use and maintenance to the customer, referring to the Instruction Manual. Ask the customer to keep the installation manual safely together with the Instruction Manual.
- Instruct the customer that the power should not be turned off even if the unit is not to be used for a long time. This will enable operation of the air-conditioner any time. (Since the compressor bottom is warmed by the crank case heater, seasonal compressor trouble can be prevented.)

9. CAUTIONS FOR SERVICING (for R410A and compatible machines)

- (1) To avoid mixing of different types of oil, use separate tools for each type of refrigerant.
- (2) To avoid moisture from being absorbed by the ice machine oil, the time for when the refrigerant circuit is open should be kept as short as possible. (Within 10 min. is ideal.)
- (3) For other piping work, airtightness testing, vacuuming, and refrigerant charging, refer to section 4, REFRIGERANT PIPING.
- (4) Diagnostic Inspection Procedures
For the meanings of failure diagnosis messages, please refer to the technical manual.
- (5) 7-segment LED indication
Data are indicated when so chosen with the indication selector switch. For the details of indication, please refer to the technical manual.
- (6) Internal wiring
After maintenance, all wiring, wiring ties and the like, should be returned to their original state and wiring route, and the necessary clearance from all metal parts should be secured.

5.2 Check operation procedure

PCB012D027A

Check operation

It is recommended to practice the check operation before the test run.
(You may test run or perform normal operation even if the check operation is not performed.)
For details of check operation, refer to the technical manual.

Important:

- Before starting the check operation, complete the address setting of indoor and outdoor units and the refrigerant charge.
 - You cannot check precisely unless proper quantity of refrigerant is charged.
 - You cannot perform the check operation when the system is stopped under abnormal condition.
 - You cannot perform the check operation when total capacity of connected indoor units is less than 80% of outdoor units.
 - You cannot perform the check operation if the communication protocol is the conventional Superlink (previous SL).
 - Don't perform the check operation at the same time on a plural number of refrigerant systems. You cannot check precisely.
 - Perform the check operation within the applicable temperature range (Outdoor air temperature: 0 - 43°C, indoor air temperature: 10 - 32°C). You cannot start the check operation if it is out of the applicable temperature range.
 - You cannot check the fresh air ventilation indoor unit and the outdoor air processing unit. (You can check indoor units other than the fresh air ventilation indoor unit and the outdoor air processing unit on the same refrigerant system.)
 - You cannot perform the check operation if the connected indoor unit is only one in one refrigerant system.
 - You cannot perform the check operation if it is set at 0% in the demand mode or capacity save mode.
 - Turn on the crankcase heater 6 hours before the check operation.
- (If the degree of overheat at the under-dome is lower than 15°C, the check operation may not start because of the protective control.)

(1) Check item

Check operation allows confirming the following points.

- Whether the service valve is closed or not (Open/close check)
- Whether refrigerant pipes and signal line are connected properly on indoor/outdoor units or not (Mismatch check)
- Whether the indoor unit expansion valve operates properly or not (Expansion valve failure check)

(2) Procedure of check operation

(a) Start of check operation

- Confirm that all of SW3-7 (Forced cooling/heating mode), SW5-1 (Test run), SW5-2 (Test run cooling setting) and SW5-3 (Pump-down operation) are turned OFF.
- Change then SW3-5 (Check operation) OFF→ON to start the check operation.
- It takes normally about 15 - 30 minutes from the start to the end of check operation. (Max. 80 minutes)

(b) Termination of check operation and result display

- As the check operation terminates, the system stops automatically and displays the result on the 7-segment indicator.

<Normal termination>

- "CHO End" is shown on the 7-segment indicator.
- Return SW3-5 to OFF setting. 7-segment indicator returns to normal display.

<Termination by error>

- Error is displayed on the 7-segment indicator.
- Correct the abnormal condition referring to the "Check Point" column, and return SW3-5 to OFF.
- Restart then the check operation from (2) (a).

7-segment display during check operation

Code	Data	Content
H1	Max. remaining time	• Preparing for check operation. Indicates the maximum remaining time (minute).
H2	Max. remaining time	• During the check operation. Indicates the maximum remaining time (minute).
CHO	End	• Normal termination of check operation.

Display on 7-segment indicator after check operation

Code	Data	Content	Check Point
CHL	---	Service valve is closed. (Refrigerant circuit is choked somewhere.)	<ul style="list-style-type: none"> • Is the service valve of outdoor unit closed? • Is the low pressure sensor normal? (Detection pressure can be confirmed on 7-segment indicator.) • Is the coil connector of indoor unit expansion valve connected? • Is the expansion valve coil of indoor unit detached from the valve body? • Is the heat exchanger sensor of indoor unit normal? (Check for sensor disconnection.)
CHU	Abnormal indoor unit No.	Mismatch of refrigerant pipes/signal line. Refrigerant is not circulated in the abnormal indoor unit.	<ul style="list-style-type: none"> • Are refrigerant pipes/signal line connected properly between indoor and outdoor units? • Is the coil connector of indoor unit expansion valve connected? • Is the expansion valve coil of indoor unit detached from the valve body? • Is the heat exchanger sensor of indoor unit normal? (Check for sensor disconnection.)
CHJ	Abnormal indoor unit No.	Expansion valve does not operate properly on the abnormal indoor unit.	<ul style="list-style-type: none"> • Is the coil connector of indoor unit expansion valve connected? • Is the expansion valve coil of indoor unit detached from the valve body? • Is the heat exchanger sensor of indoor unit normal? (Check for sensor disconnection.)
CHE	---	Termination of check operation by error	<ul style="list-style-type: none"> • Is any error (E??) indicated on indoor or outdoor units? • Is signal line connected without loose? • Was any SW setting changed during check operation?
CHE	Abnormal indoor unit No.	Termination of check operation by error. Indicated indoor unit is under abnormal condition.	<ul style="list-style-type: none"> • Is any error (E??) indicated on indoor or outdoor units? • Is signal line connected without loose? • Is the power supply turned ON at the indoor unit side?

*Errors other than the above may be indicated by the detection of error. In such occasion, correct the matter by referring to the technical manual.

*Code and Data are indicated alternately by 4-second intervals.

5.3 Method for connecting the accessory pipe

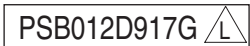

Be sure to use the accessory pipe to connect the operation valve on the gas side with the field pipe.

- * Connect the attached pipe according to the following steps ① - ⑤. When tightening the flare, connect the pipe securely by pressing the flared face of pipe against the operation valve. When brazing between the pipe in place and the attached pipe, confirm that no excessive force is applied to the flare joint. Otherwise gas could leak from the flare joint.
- ① Referring to Table ① and Table ②, prepare the straight pipe and the elbow in the field, which are used in the construction examples A-D applicable to the connecting direction.
- ② Firstly, use the accessory pipe to assemble the connecting pipe assembly outside the outdoor unit. As shown in the figures of construction examples (A) ~ (D) applicable to the connecting direction (chain double dashed line), braze the accessory pipe and the parts prepared in the above ①.
 - Orient the accessory pipe according to the dimensions as shown in □ of Fig. 1.
- ③ After assembly of the connecting pipe, connect it to the service valve on the gas side inside the outdoor unit. Tighten the flare nut with appropriate torque.
- ④ After connection of the connecting pipe assembly to the service valve on the gas side, braze the connecting pipe assembly and the field pipe.
- ⑤ After the brazing, insulate using the attached heat insulating material and band as shown by Fig. 2.

Table ① Parts used for the connecting pipe assembly

No.	Name	Quantity	Remark
1	Accessory pipe	1	Accessory
2	Heat insulating material	1	Accessory
3	Band	2	Accessory
4	Straight pipe ①	1	Procured at the field
5	Straight pipe ②	1 or 0	Procured at the field (Not required for downward direction)
6	Elbow	1 or 0	Procured at the field (Not required for downward direction)

Table ② Length and specification of straight pipe (Procured in the field)

	Ⓐ Downward	Ⓑ Forward	Ⓒ Rightward	Ⓓ Backward
Straight pipe ①	270 mm or over	70-120mm	70-120mm	70-120mm
Straight pipe ②	—	125mm or over	125mm or over	515mm or over

- Be sure to use pipes of 1/2H material, and wall thickness above 1mm. (Pressure resistance of O-type pipe is not enough)

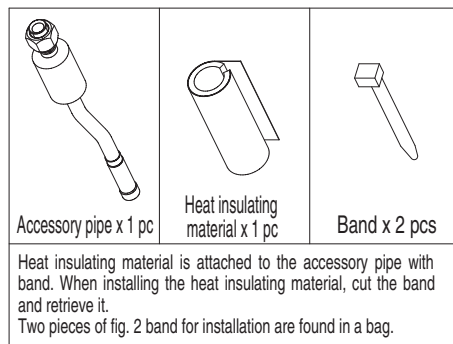

Pipe specification	
224	ø19.05 × T1.0
280	ø22.22 × T1.0
335	ø25.4 × T1.0

- Select and use the pipes, which are procured in the field, according to the specification that corresponds to the outdoor unit capacity as described in the installation manual.

About brazing

Be sure to braze while supplying nitrogen gas.

- If no nitrogen gas is supplied, a large amount of impurity (oxidized film) will be generated, which may clog the capillary tube and the expansion valve, resulting in fatal malfunction.

Proper torque	
ø19.05	100-120N·m

【Connection example (A)~(D) applicable to the connecting direction.】

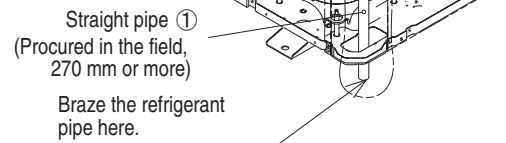
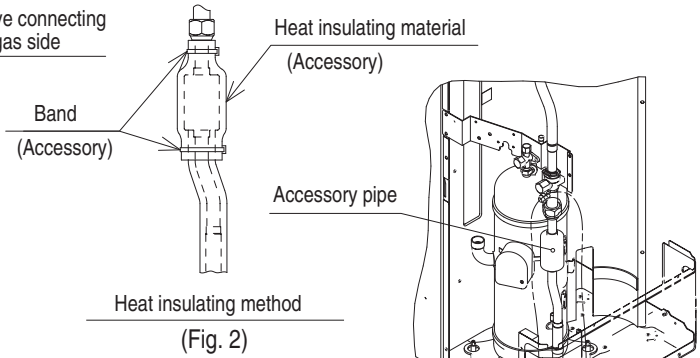
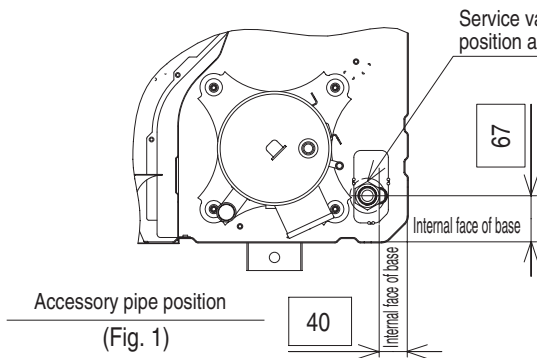

Connection example of refrigerant pipe - (A)
(Downward connection)

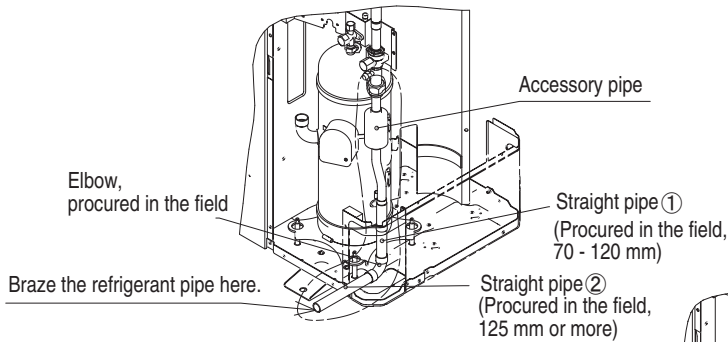

Connection example of refrigerant pipe - (B)
(Forward connection)

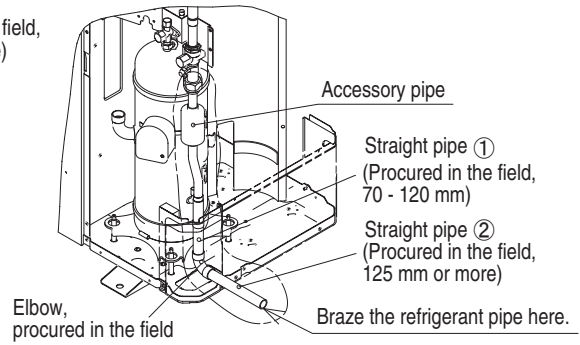

Connection example of refrigerant pipe - (C)
(Rightward connection)

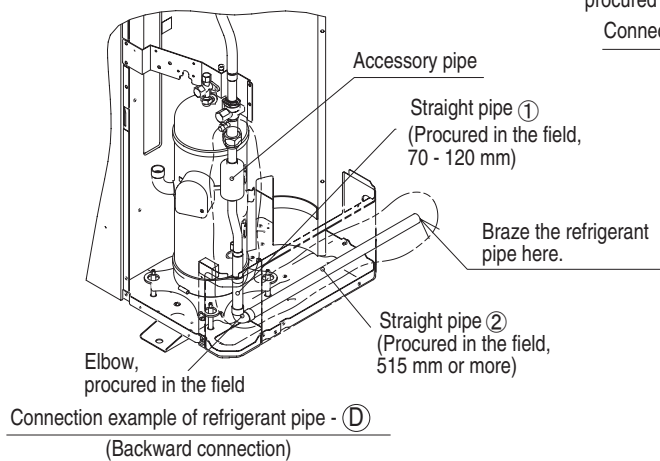

Connection example of refrigerant pipe - (D)
(Backward connection)

5.4 Instructions for installing the branch pipe set

PSB012D855D

- ⦿ This manual describes the specifications of branching pipe set and header set installation. For outdoor unit installation and indoor unit installation, please refer to the respective installation manuals supplied with your outdoor unit and indoor unit.
- ⦿ Before you set about installation work, please read this manual carefully so that you can carry out installation work according to the instructions contained herein.
- Please read the safety instructions contained in the installation manual supplied with your outdoor unit carefully and carry out installation work unerringly.
- When installation work is completed, conduct a test run to check the installation for any anomaly. Please also give the customer necessary instructions as to the operation and maintenance of the unit pursuant to the instruction manual (supplied with the indoor unit).
- Please ask the customer to keep the installation manual on the customer's part together with the instruction manual.

PARTS LIST

Branching pipe set type	Gas side	Liquid side	Different diameter pipe joint
Branching pipe set	DIS-22-1G 		None
	DIS-180-1G 		
	DIS-371-1G 		
	DIS-540-3 		
Outdoor unit's branching pipe set	DOS-2A-3 		
	DOS-3A-3 Branch pipe 1 	Branch pipe 1 	
	Branch pipe 2 	Branch pipe 2 	

Branching pipe set type	Gas side	Liquid side	Different diameter pipe joint
HEAD4-22-1G			None
HEAD6-180-1G			
HEAD8-371-2			
HEAD8-540-3			

INSTALLATION PROCEDURE

(1) Please select an appropriate branching pipe set model and a pipe size by consulting with the installation manual of the indoor unit or other relevant technical documents.

Attention

- Use a pipe conforming to a pipe size specified for indoor unit connection for the section between an indoor unit and a branching pipe.
- Use a pipe conforming to a pipe size specified for outdoor unit connection for the section between an outdoor branching pipe and an outdoor unit.

(2) Cut a branching pipe set or a different diameter joint with a pipe cutter to make it fit for a selected pipe size before application.

Attention

- In cutting pipes, always use a pipe cutter. Remove burrs from a cut end when you cut a pipe. In doing so, keep a cut end downward so that no chips or burrs may enter the pipe.
- Take utmost care so that no foreign matter such as dust or water may enter piping during installation work.
 - Please cover all the open ends of piping until installation work is completed. Particularly, any openings in the section of piping laid outdoors should be sealed stringently.
 - As long as possible, avoid open ends left facing upward. Make them face either horizontally or downward.
- A branching joint (for both gas and liquid) must always be positioned in such a way that it branches either horizontally or vertically.

Use pipe cutter to cut pipes.

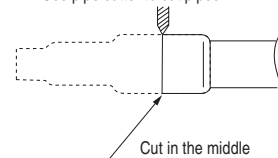

• In the case of a branching pipe set (model type DIS)

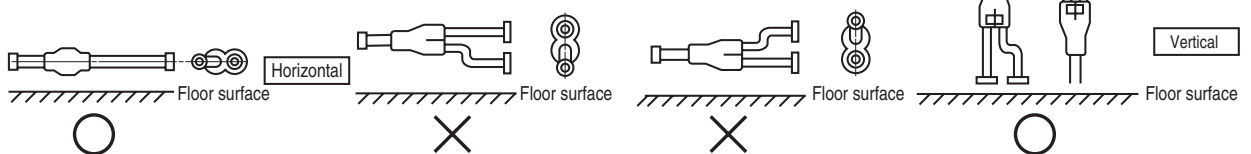

• In the case of a outdoor unit's branching pipe set (model type DOS)

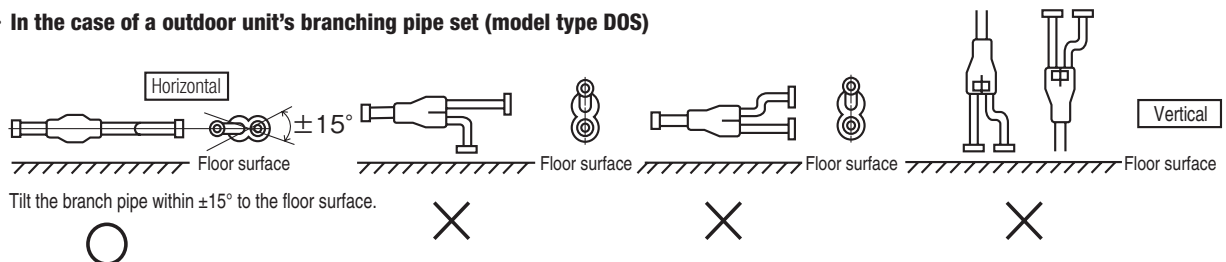

Tilt the branch pipe within $\pm 15^\circ$ to the floor surface.

• In the case of a header set (model type HEAD)

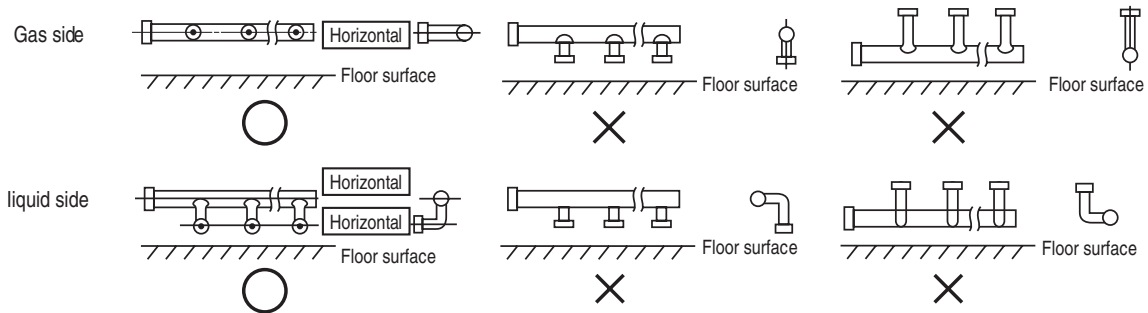

④ When using the outdoor unit's branch pipe set, make sure to secure a straight section of 500 mm or more for both the gas and liquid pipes before branching them.

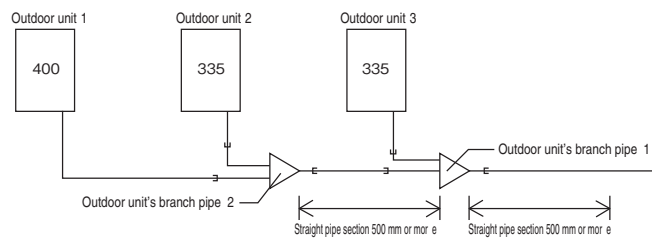

- ⑤ Always apply nitrogen gas when soldering joints. If nitrogen gas is not applied, a large amount of film oxide will be formed which could lead to a critical failure in the unit. Use caution to prevent moisture or any foreign matters from entering the pipe when connecting pipe ends.
For the method of air tightness testing and pulling air, please refer to the installation manual of the outdoor unit.
- ⑥ Do not leave piping with any open ends uncovered to prevent water or foreign matters from entering inside.

(3) Please dress it with an attached insulation sheet for heat insulation. (Please dress both liquid and gas sides.)

Attention

- ① Apply an attached insulation sheet along a pipe, tape the joining line with a joint tape (to be procured on the installer's part) for complete sealing, and wrap the pipe and insulation sheet entirely with a tape.
- ② Dress both liquid and gas pipes with attached insulation sheets for heat insulation.
- ③ Ensure that the liquid pipe is given the heat insulation as good as that of the gas pipe. The absence of heat insulation can cause dripping water from dew condensing on the pipe or performance degradation.

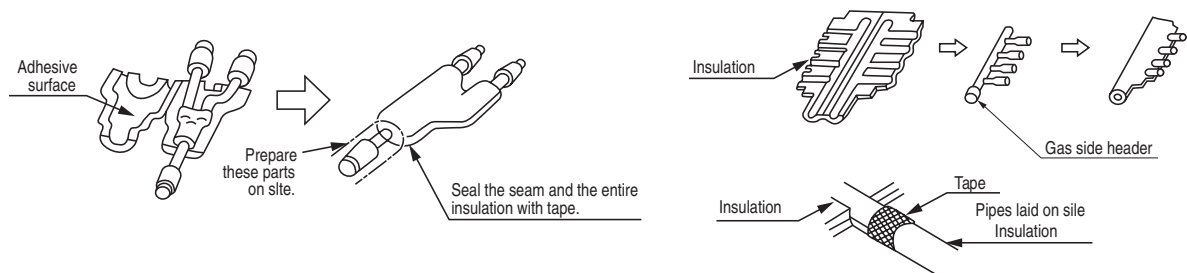

(4) How to select a branching pipe

1) Method to select a branch pipe set (Type DIS)

- An appropriate branching pipe size varies depending on the capacity of connected indoor units (combined total capacity connected downstream), so please choose from the table below.
- In the case of a 140/160 (5/6HP) outdoor unit, however, select DIS-22-1G. (Even if the capacity of connected indoor units reaches 180 or higher, select DIS-22-1G.)

Total capacity downstream	Branching pipe set model type
less than 180	DIS-22-1G
180 or higher – less than 371	DIS-180-1G
371 or higher – less than 540	DIS-371-1G
540 or more	DIS-540-3

Attention

- ① Use a pipe conforming to a pipe size specified for indoor unit connection for the section between an indoor unit and an indoor unit side branching pipe.
- ② A branching joint (for both gas and liquid) must always be positioned in such a way that it branches either horizontally or vertically.

2) How to select a header set

- Depending on the number of units connected, connect plugged pipes (to be procured on the installer's part) at a branching point (on the indoor unit connection side).
- For the size of a plugged pipe, please refer to the documentation for a header set (option part).
- In the case of a 140/160 (5/6HP) outdoor unit, however, select HEAD4-22-1G. (Even if the capacity of connected indoor units reaches 180 or higher, select HEAD4-22-1G.)

Total capacity downstream less than 180	Header set model type HEAD4-22-1G	Number of branches Up to 4 branches
180 or higher – less than 371	HEAD6-180-1G	Up to 6 branches
371 or higher – less than 540	HEAD8-371-2	Up to 8 branches
540 or more	HEAD8-540-3	Up to 8 branches

Attention

- ① Use a pipe conforming to a pipe size specified for indoor unit connection for the section between a header and an indoor unit.
- ② Always position a header (both gas and liquid headers) in such a way that it branches horizontally.
- ③ No 224 or 280 indoor unit is connectable to a header.

(5) Example of piping

Example 1: Branching type configuration

Connected capacity: 294

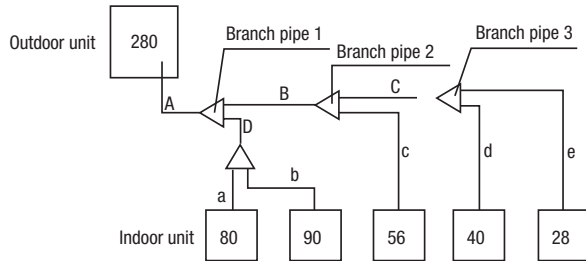

Selection of a branching pipe set

Mark	Selection procedure	Branching pipe set
Branch pipe 1	Combined total capacity of indoor units connected downstream $(80+90+56+40+28)=294$	DIS-180-1G
Branch pipe 2	Combined total capacity of indoor units connected downstream $(56+40+28)=124$	DIS-22-1G
Branch pipe 3	Combined total capacity of indoor units connected downstream $(40+28)=68$	DIS-22-1G

Example 2: Header type configuration

Connected capacity: 272

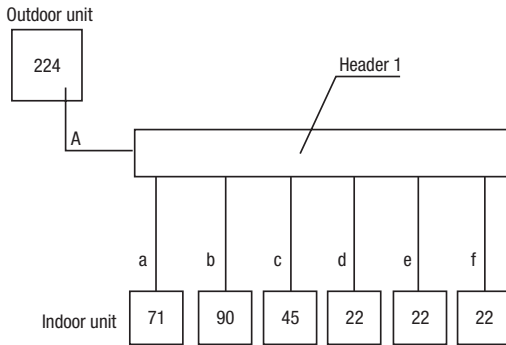

Selection of a header set

Mark	Selection procedure	Header set
Header 1	Combined total capacity of indoor units connected downstream $(71+90+45+22+22+22)=272$	HEAD6-180-1G

Example 3: Branching + Header mixed type configuration

Connected capacity: 1394

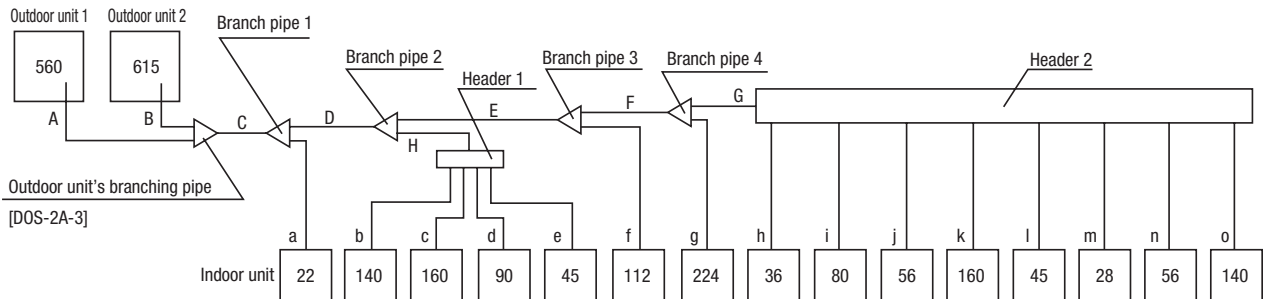

Selection of a branching pipe set

Mark	Selection procedure	Branching pipe set
Branch pipe 1	Combined total capacity of indoor units connected downstream $(22+140+160+90+45+112+224+36+80+56+160+45+28+56+140)=1394$	DIS-540-3
Branch pipe 2	Combined total capacity of indoor units connected downstream $(140+160+90+45+112+224+36+80+56+160+45+28+56+140)=1372$	DIS-540-3
Branch pipe 3	Combined total capacity of indoor units connected downstream $(112+224+36+80+56+160+45+28+56+140)=937$	DIS-540-3
Branch pipe 4	Combined total capacity of indoor units connected downstream $(224+36+80+56+160+45+28+56+140)=825$	DIS-540-3

Selection of a header set

Mark	Selection procedure	Header set
Header 1	Combined total capacity of indoor units connected downstream $(140+160+90+45)=435$	HEAD8-371-2
Header 2	Combined total capacity of indoor units connected downstream $(36+80+56+160+45+28+56+140)=601$	HEAD8-540-3

6. OUTDOOR UNIT DISASSEMBLY PROCEDURE

DISASSEMBLY PROCEDURE

WARNING Precautions for safety

- Read these "Precautions for safety" carefully before starting disassembly work and do it in the proper way.
- When disassembling, be sure to turn off the power. When disassembling the electrical components, check the electrical wiring diagram.
- The electrical components are under high voltage by the operation of the booster capacitor.
Fully discharge the capacitor before commencing a repair work. Failure to observe this warning could result in electric shock.
- When parts of refrigerant cycle is disassembled by welding, be sure to work after collecting a refrigerant, if the refrigerant isn't collected, the unit might explode.
- Be sure to collect refrigerant without spreading it in the air.
- These contents are an example. Please refer to a similar part of actual unit.

PROCEDURE & PICTURES (FDC series)

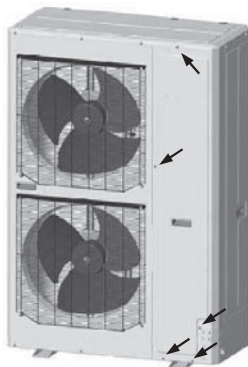

- 1. To remove the service panel**
(1) Remove 5 service panel fixing screws and remove it.

- 2. To remove the fan motor (FM)**
(1) Remove the service panel.(See No.1)
(2) Disconnect the motor connector(FMxx) on PCB in control box.
(3) Remove 4 fan guard fixing screws and remove it.(○ mark)
(4) Remove the propeller fan fixing nut and remove it.(□ mark)
(5) Remove 4 fan motor fixing nuts and remove it.(← mark)

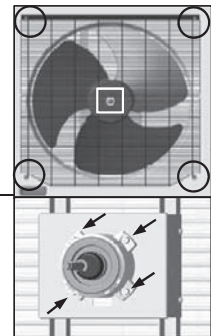

- 3. To remove the 4-way valve (20S)**
(1) Remove the service panel.(See No.1)
(2) Disconnect the coil of 4-way valve connector (CNS,CNNx) on PCB in control box.
(3) Remove the coil of 4-way valve fixing screws (← mark) and remove it.
(4) Remove welded part of 4-way valve by welding. (□ mark)

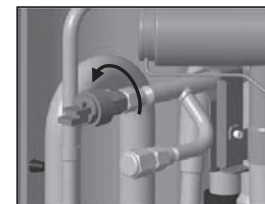
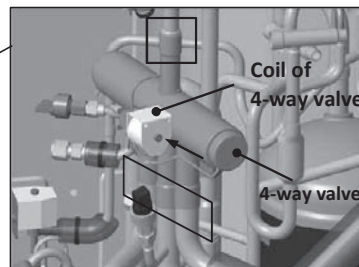

- 4. To remove the high pressure sensor (PSH)**
(1) Remove the service panel.(See No.1)
(2) Disconnect the PSH connector(CNLx) on PCB in control box.
(3) Turn PSH to the left and remove it.
(Double spanners are needed.)

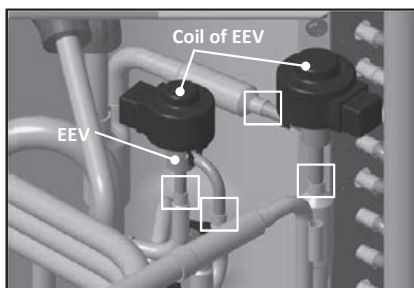

- 5. To remove the electronic expansion valve (EEV)**
(1) Remove the service panel.(See No.1)
(2) Disconnect the EEV connector(CNEEVx) on PCB in control box.
(3) Remove the coil of EEV by pull out on the top.
(4) Remove welded part of EEV by welding. (□ mark)

- 7. To remove bypass valve (SV)**
(1) Remove the service panel.(See No.1)
(2) Disconnect the SV connector(CNNxx) on PCB in control box.
(3) Remove the coil of SV fixing screws. (← mark)
(4) Remove 2 coil of SV fixing screws and remove it.(□ mark)
(5) Remove welded part of SV by welding. (○ mark)

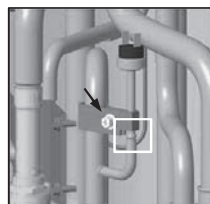

- 6. To remove the high pressure switch (63H)**
(1) Remove the service panel.(See No.1)
(2) Disconnect the 63H connector(CNH or CNQx) on PCB in control box.
(3) Remove the metal fitting fixing screws and remove it. (← mark)
(4) Remove welded part of high pressure switch by welding. (□ mark)

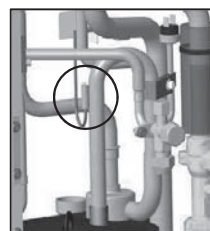

- 8. To remove the sensors (example "Tho-D1")**
(1) Remove the service panel.(See No.1)
(2) Disconnect the Tho-D1 connector(CNTH) on PCB in control box.
(3) Pull out the temperature sensor "Tho-D1 , THxx" from the sensor holder.

PROCEDURE & PICTURES

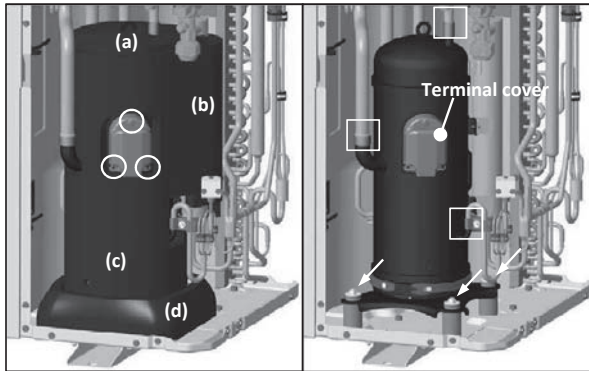

9. To remove the compressor (CM)

- (1) Remove the service panel.(See No.1)
- (2) Remove the insulation which covers compressors. (Strings (a)~(d) should be loosen.)
- (3) Remove 3 terminal cover fixing bolts(○ mark) and remove it and disconnect the power wiring.
- (4) Remove welded part of compressor by welding. (□ mark)
- (5) Remove 3 compressor fixing nuts(← mark) using spanner or adjustable wrench.

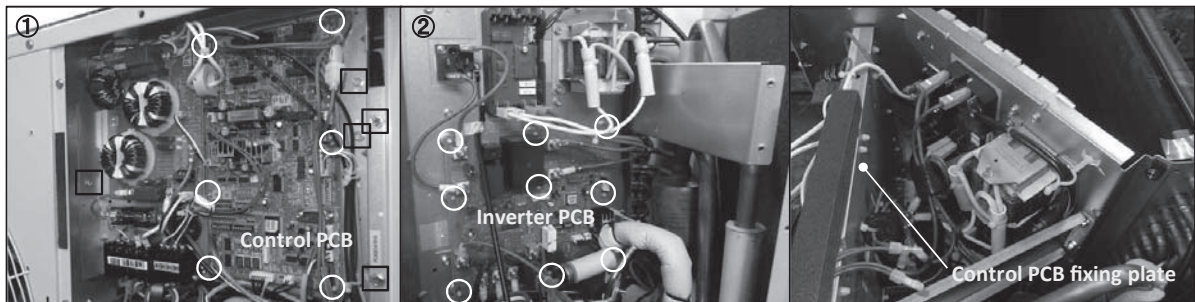

10. To remove the printed circuit board (PCB)

- (1) Remove the service panel and top panel.
- (2) Pull off all the inserted connectors of control PCB.(Pic.①)
- (3) Take off 6 control PCB fixing locking support and remove it.(○ mark, Pic.①)
- (4) Remove 5 plate fixing screws and open it.(□ mark, Pic.①)
- (5) Pull off all the inserted connectors of inverter PCB.(Pic.②)
- (6) Take off 9 inverter PCB fixing locking support and remove it.(○ mark, Pic.②)

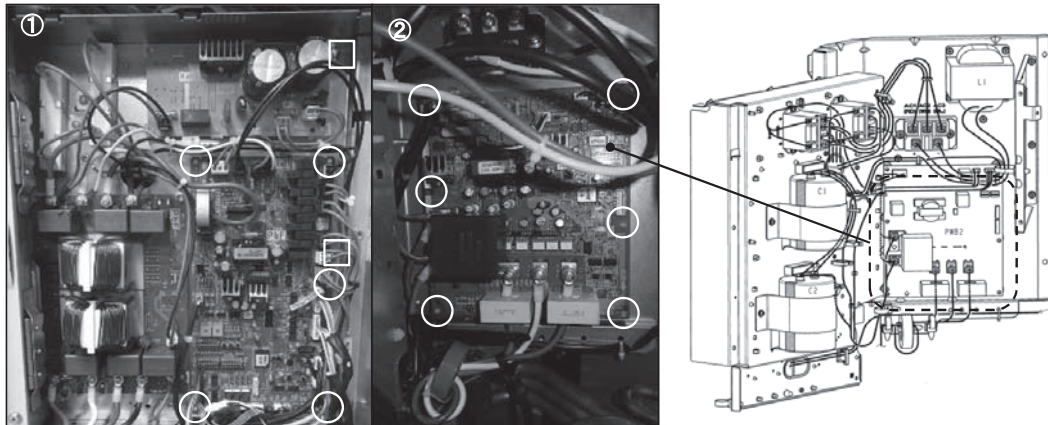

11. To remove the printed circuit board (PCB)

◀Hinge control type▶

- (1) Remove the service panel.
- (2) Pull off all the inserted connectors of control PCB.(Pic.①)
- (3) Take off 5 control PCB fixing locking supports and remove it.(○ mark, Pic.①)
- (4) Remove 2 plate fixing screws and open it.(□ mark, Pic.①)
- (5) Pull off all the inserted connectors of inverter PCB.(Pic.②)
- (6) Take off 6 inverter PCB fixing locking supports and remove it.(○ mark, Pic.②)

7. INDOOR UNIT DISASSEMBLY PROCEDURE

DISASSEMBLY PROCEDURE

WARNING Precautions for safety

- Read these "Precautions for safety" carefully before starting disassembly work and do it in the proper way.
- When disassembling, be sure to turn off the power. When disassembling the electrical components, check the electrical wiring diagram.
- The electrical components are under high voltage by the operation of the booster capacitor.
Fully discharge the capacitor before commencing a repair work. Failure to observe this warning could result in electric shock.
- When parts of refrigerant cycle is disassembled by welding, be sure to work after collecting a refrigerant, if the refrigerant isn't collected, the unit might explode.
- Be sure to collect refrigerant without spreading it in the air.
- These contents are an example. Please refer to a similar part of actual unit.

PROCEDURE & PICTURES (FDT series)



- 1. To remove the lid of control box**
(1) Remove 2 lid fixing screws and remove it.

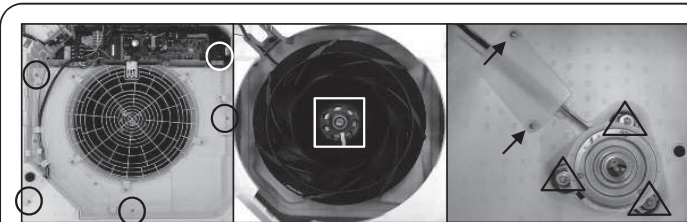

- 3. To remove the impeller and motor (FM)**
(1) Remove the lid of control box.(See No.1)
(2) Disconnect the motor connector(CNMx) on PCB in control box.
(3) Remove 5 bellmouth fixing screws and remove it.(O mark)
(4) Remove the impeller fixing nut and remove it.(□ mark)
(5) Remove 2 plate fixing screws and remove it.(← mark)
(6) Remove 3 motor fixing nuts and remove it.(△ mark)

- 2. To remove the printed circuit board (PCB)**
(1) Remove the lid of control box.(See No.1)
(2) Pull off all the inserted connectors.
(3) Take off 6 fixing hooks and remove it.

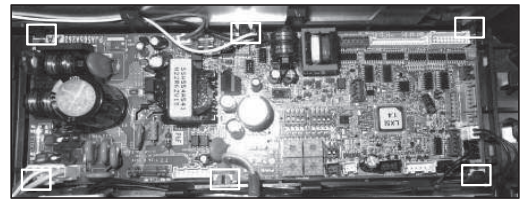

- 4. To remove the drain pan**
(1) Remove the lid of control box.(See No.1)
(2) Pull off all the inserted connectors.
(3) Remove 2 plate fixing screws and remove it.
(O mark)
(4) Remove 2 lid fixing screws and remove it.
(□ mark)
(5) Remove 4 drain pan fixing screws and remove it.
(← mark)

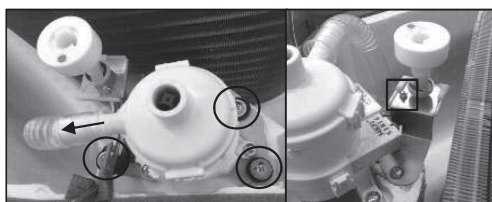

- 5. To remove drain pump (DM) and float switch (FS)**
(1) Remove the drain pan.(See No.4)
(2) Pull the hose to the arrow direction and remove it.
(3) Remove 3 drain pump fixing screws and remove it.(O mark)
(4) Remove the float switch fixing screw and remove it.(□ mark)

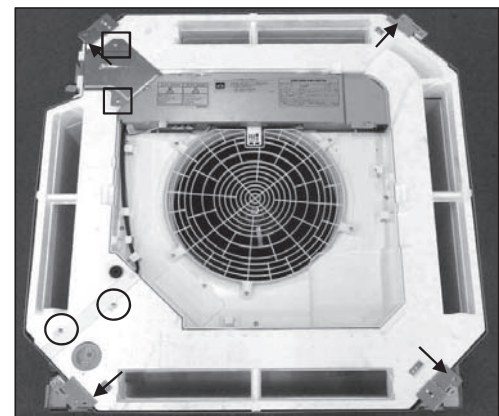

- 6. To remove the sensors (example "Thi-R1")**
(1) Remove the drain pan.(See No.4)
(2) Pull out the temperature sensor "Thi-R1" from the sensor holder.

PROCEDURE & PICTURES

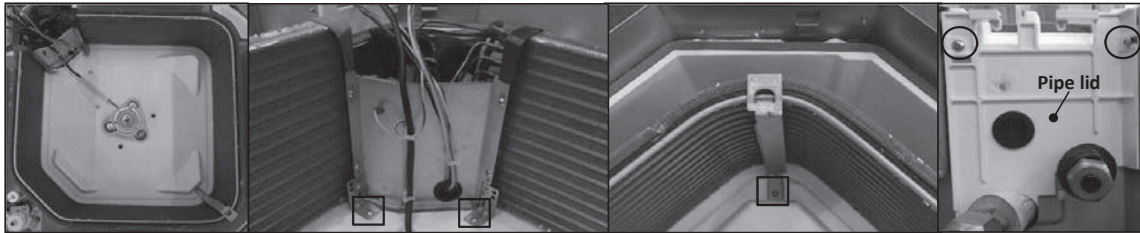

7. To remove the heat exchanger assembly

- (1) Remove the drain pan.(See No.4)
- (2) Remove 2 pipe lid fixing screws and remove it.(○ mark)
- (3) Remove 3 heat exchanger assembly fixing screws and remove it.(□ mark)

8. To remove the Electronic Expansion Valve (EEV)

- (1) Remove the heat exchanger assembly.(See No.7)
- (2) Remove the coil of EEV by pull out on the top.
- (3) Remove welded part of EEV by welding.(○ mark)

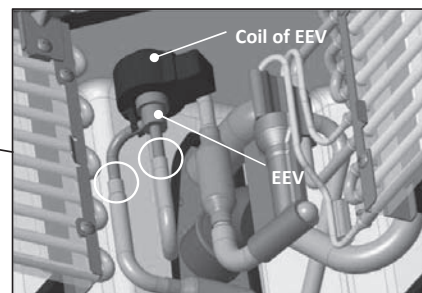

General view

DISASSEMBLY PROCEDURE

WARNING **Precautions for safety**

- Read these "Precautions for safety" carefully before starting disassembly work and do it in the proper way.
- When disassembling, be sure to turn off the power. When disassembling the electrical components, check the electrical wiring diagram.
- The electrical components are under high voltage by the operation of the booster capacitor.
Fully discharge the capacitor before commencing a repair work. Failure to observe this warning could result in electric shock.
- When parts of refrigerant cycle is disassembled by welding, be sure to work after collecting a refrigerant, if the refrigerant isn't collected, the unit might explode.
- Be sure to collect refrigerant without spreading it in the air.
- These contents are an example. Please refer to a similar part of actual unit.

PROCEDURE & PICTURES (FDTC series)

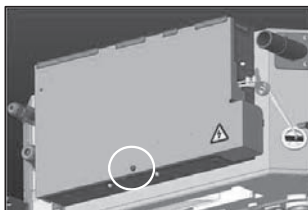

- 1. To remove the lid of control box**
(1) Remove the lid fixing screw and remove it.

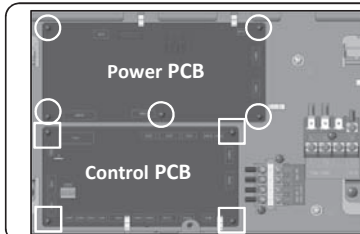

- 2. To remove the printed circuit board (PCB)**
(1) Remove the lid of control box.(See No.1)
(2) Pull off all the inserted connectors.
- **Power PCB**
(3) Take off 5 power PCB fixing locking supports and remove it.(○ mark)
 - **Control PCB**
(4) Take off 4 control PCB fixing locking supports and remove it.(□ mark)

- 3. To remove the impeller and motor (FM)**
(1) Remove the lid of control box.(See No.1)
(2) Disconnect the motor connector(CNMx) in the middle of wiring.
(3) Remove 4 bellmouth fixing screws and remove it.(○ mark)
(4) Remove the impeller fixing nut and remove it.(□ mark)
(5) Remove 2 plate fixing screws and remove it.(← mark)
(6) Remove 3 motor fixing nuts and remove it.(△ mark)

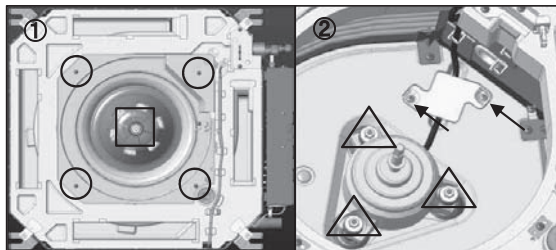

- 4. To remove the drain pan**
(1) Remove 2 plate fixing screws and remove it. (○ mark)
(2) Remove 4 drain pan fixing screws and remove it. (← mark, Four corners)

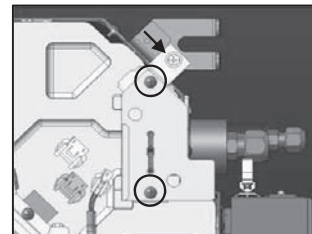

- 5. To remove drain pump (DM) and float switch (FS)**
(1) Remove the lid of control box.(See No.1)
(2) Disconnect the drain pump connector(CNRx) and float switch connector(CNix) in the middle of wiring.
(4) Remove the drain pan.(See No.4)
(5) Pull the hose to the arrow direction and remove it.
(6) Remove 3 drain pump fixing screws and remove it.(○ mark)
(7) Remove the float switch fixing screw and remove it.(□ mark)

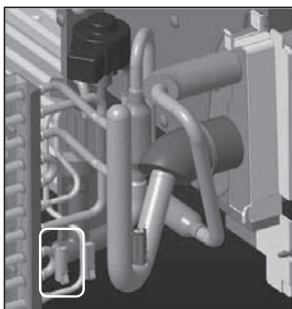
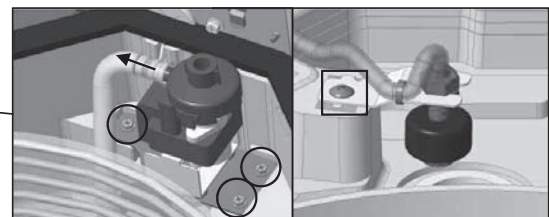

- 6. To remove the sensors (example "Thi-R1")**
(1) Remove the lid of control box.(See No.1)
(2) Disconnect the Tho-R1 connector(CNNx) in the middle of wiring.
(3) Remove the drain pan.(See No.3)
(4) Pull out the temperature sensor "Thi-R1" from the sensor holder.

PROCEDURE & PICTURES

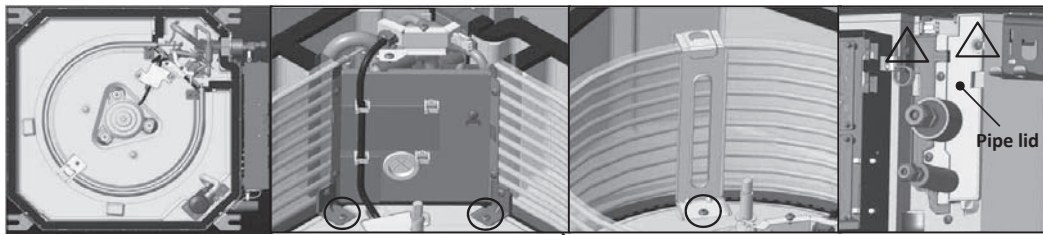

7. To remove the heat exchanger assembly

- (1) Remove the drain pan.(See No.4)
- (2) Remove 2 plate fixing screws and remove it.(Δ mark)
- (3) Remove 3 heat exchanger assembly fixing screws and remove it.(O mark)

8. To remove the Electronic Expansion Valve (EEV)

- (1) Remove the heat exchanger assembly.(See No.7)
- (2) Remove the coil of EEV by pull out on the top.
- (3) Remove welded part of EEV by welding.(O mark)

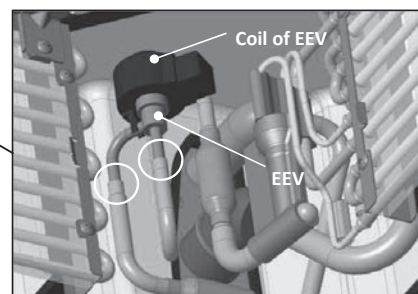

General view

DISASSEMBLY PROCEDURE

WARNING **Precautions for safety**

- Read these "Precautions for safety" carefully before starting disassembly work and do it in the proper way.
- When disassembling, be sure to turn off the power. When disassembling the electrical components, check the electrical wiring diagram.
- The electrical components are under high voltage by the operation of the booster capacitor.
Fully discharge the capacitor before commencing a repair work. Failure to observe this warning could result in electric shock.
- When parts of refrigerant cycle is disassembled by welding, be sure to work after collecting a refrigerant, if the refrigerant isn't collected, the unit might explode.
- Be sure to collect refrigerant without spreading it in the air.
- These contents are an example. Please refer to a similar part of actual unit.

PROCEDURE & PICTURES (FDTW series)

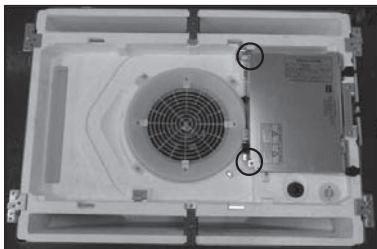

- 1. To remove the lid of control box**
(1) Remove 2 lid fixing screws and remove it.

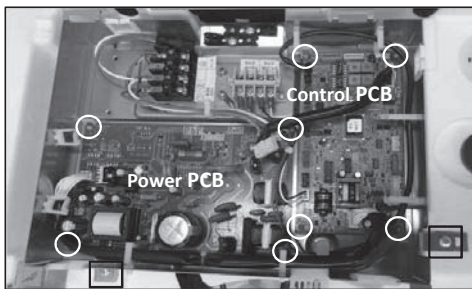

- 2. To remove the printed circuit board (PCB)**
(1) Remove the lid of control box.(See No.1)
(2) Pull off all the inserted connectors.
- **Control PCB**
(3) Take off 4 control PCB fixing locking supports and remove it.(○ mark)
 - **Power PCB**
(4) Take off 4 power PCB fixing locking supports and remove it.(○ mark)

- 3. To remove the control box**
(1) Remove the lid of control box.(See No.1)
(2) Pull off all the inserted connectors.
(3) Remove 2 control box fixing screws(□ mark) and remove it.

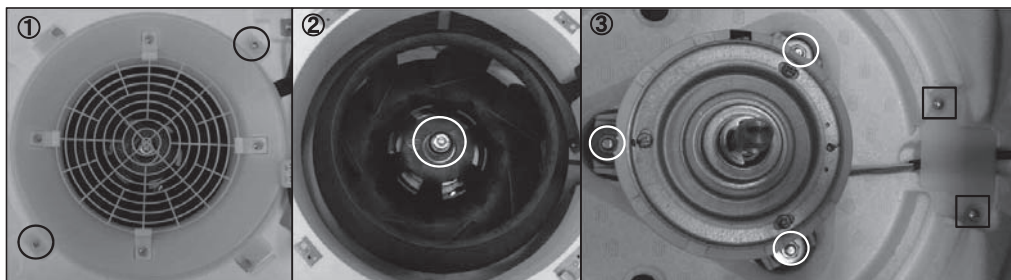

- 4. To remove the impeller and motor (FM)**
(1) Remove the lid of control box.(See No.1)
(2) Disconnect the motor connector(CNMx) on PCB in control box.
(3) Remove 2 fan guard fixing screws and remove it.(Pic.①)
(4) Remove the impeller fixing nut and remove it.(Pic.②)
(5) Remove 2 plate fixing screws and remove it.(Pic.③, □ mark)
(6) Remove 3 motor fixing nuts and remove it.(Pic.③, ○ mark)

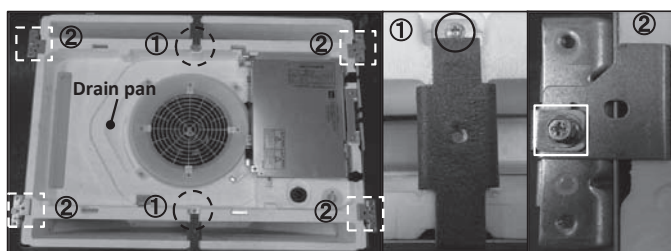

- 5. To remove the drain pan**
(1) Remove the control box.(See No.3)
(2) Remove the plate fixing screw and remove it.
(Pic.①, ○ mark)
(3) Remove the bracket fixing screw.(Pic.②, □ mark)
(4) Pull drain pan off.

PROCEDURE & PICTURES

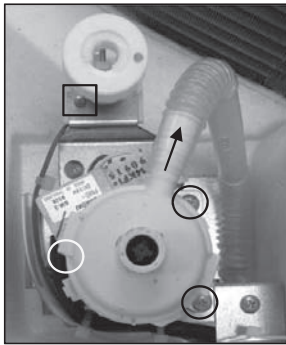

- 6. To remove the drain pump(DM) and float switch(FS)**
- (1) Remove the drain pan.(See No.5)
 - (2) Pull a hose to the arrow direction and remove it.
 - (3) Remove 3 drain pump fixing screws and remove it.(○ mark)
 - (4) Remove the float switch fixing screw and remove it.(□ mark)

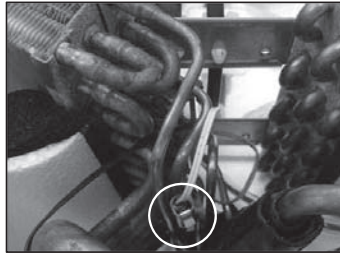

- 7. To remove the sensors (example"Thi-R1")**
- (1) Remove the drain pan.(See No.5)
 - (2) Pull out the temperature sensor "Thi-R1" from the sensor holder.

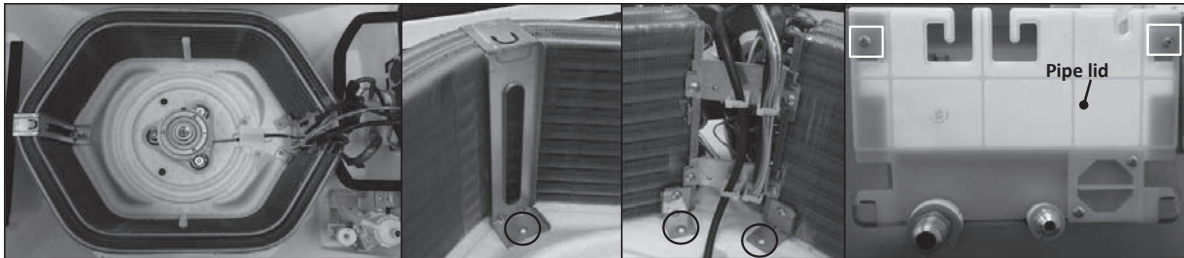

- 8. To remove the heat exchanger assembly**
- (1) Remove the drain pan.(See No.5)
 - (2) Remove 2 pipe lid fixing screws and remove it.(□ mark)
 - (3) Remove 3 heat exchanger assembly fixing screws and remove it.(○ mark)

- 9. To remove the Electronic Expansion Valve (EEV)**
- (1) Remove the heat exchanger assembly.(See No.8)
 - (2) Remove the coil of EEV by pull out on the top.
 - (3) Remove welded part of EEV by welding.(○ mark)

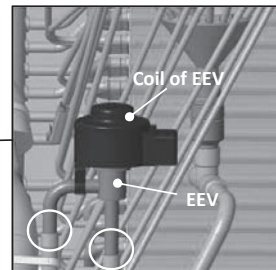

General view

DISASSEMBLY PROCEDURE

WARNING

Precautions for safety

- Read these "Precautions for safety" carefully before starting disassembly work and do it in the proper way.
- When disassembling, be sure to turn off the power. When disassembling the electrical components, check the electrical wiring diagram.
- The electrical components are under high voltage by the operation of the booster capacitor.
Fully discharge the capacitor before commencing a repair work. Failure to observe this warning could result in electric shock.
- When parts of refrigerant cycle is disassembled by welding, be sure to work after collecting a refrigerant, if the refrigerant isn't collected, the unit might explode.
- Be sure to collect refrigerant without spreading it in the air.
- These contents are an example. Please refer to a similar part of actual unit.

PROCEDURE & PICTURES (FDTQ series)

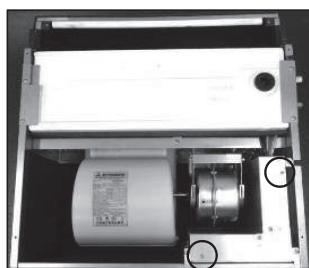

1. To remove the lid of control box
(1) Remove 2 lid fixing screws and remove it.

2. To remove the control box
(1) Remove the lid of control box.(See No.1)
(2) Pull off all the inserted connectors.
(3) Remove 3 control box fixing screws and remove it.
(4) Pull out the control box.

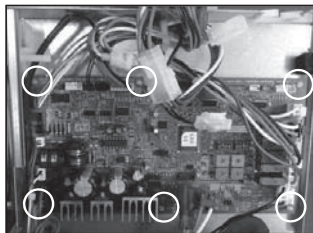
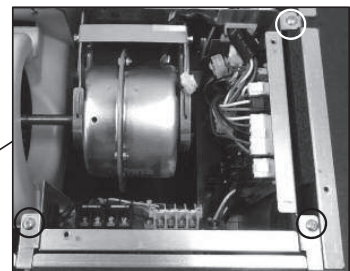

3. To remove the printed circuit board (PCB)
(1) Remove the lid of control box.(See No.1)
(2) Remove control box.(See No.2)
(3) Take off 6 PCB fixing locking supports and remove it.



4. To remove the drain pan.
(1) Remove 2 plate fixing screws and remove it.(right and left)
(2) Pull out the control box.

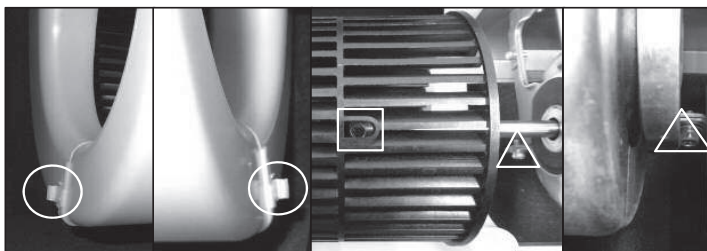

5. To remove the impeller and motor (FM)
(1) Remove the lid of control box.(See No.1)
(2) Disconnect the float switch connector(CNFx) in the middle of wiring.
(3) Take off 2 impeller casing hooks and remove it.(O mark)
(4) Remove the impeller fixing bolt and remove it.(□ mark)
(5) Remove 2 motor fixing screws and remove it.(△ mark)

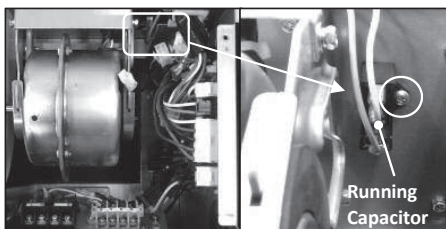

6. To remove the running capacitor of fan motor
(1) Remove the running capacitor fixing screw and remove it.

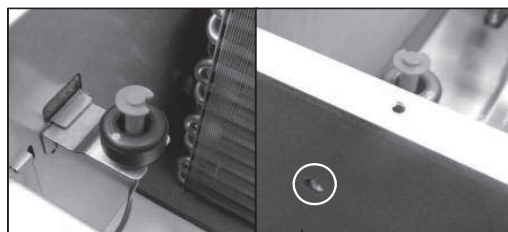

7. To remove the float switch (FS)
(1) Remove the lid of control box.(See No.1)
(2) Disconnect the float switch connector(CNix) in the middle of wiring.
(3) Remove the drain pan.(See No.4)
(4) Remove the float switch fixing screw and remove it.

PROCEDURE & PICTURES

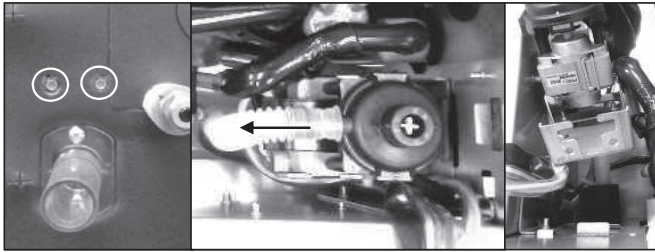

8. To remove drain pump (DM)

- (1) Remove the lid of control box.(See No.1)
- (2) Remove the drain pan.(See No.4)
- (3) Disconnect the drain pump connector(CNRx) in the middle of wiring.
- (4) Pull a hose to the arrow direction and remove it.
- (5) Remove 2 drain pump assembly fixing screws and remove it.

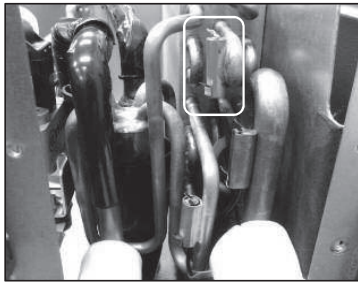

9. To remove the sensors(example"Thi-R1")

- (1) Remove the lid of control box.(See No.1)
- (2) Disconnect the Tho-R1 connector(CNNx) on PCB in control box.
- (3) Remove the drain pan.(See No.4)
- (4) Pull out the temperature sensor "Thi-R1" from the sensor holder.

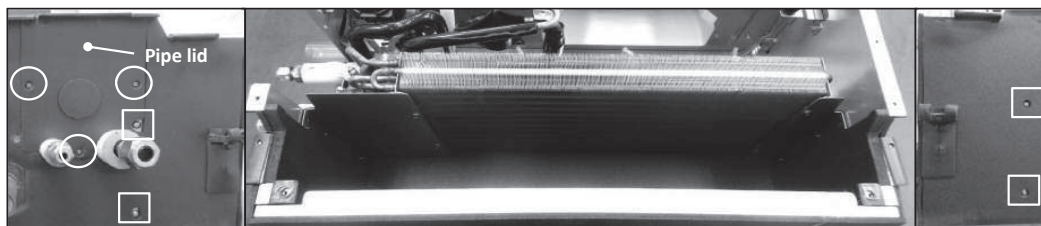

10. To remove the heat exchanger assembly

- (1) Remove the drain pan.(See No.3)
- (2) Remove 3 pipe lid fixing screws and remove it.(○ mark)
- (3) Remove 4 heat exchanger assy fixing screws and remove it.(□ mark)

11. To remove the Electronic Expansion Valve (EEV)

- (1) Remove the heat exchanger assembly.(See No.10)
- (2) Remove the coil of EEV by pull out on the top.
- (3) Remove welded part of EEV by welding.(○ mark)

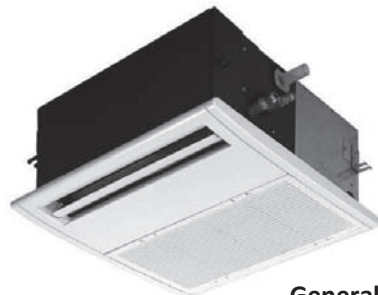
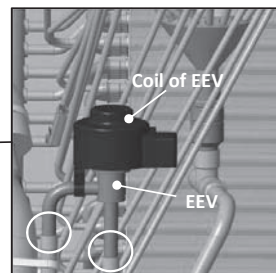

General view

DISASSEMBLY PROCEDURE

WARNING Precautions for safety

- Read these "Precautions for safety" carefully before starting disassembly work and do it in the proper way.
- When disassembling, be sure to turn off the power. When disassembling the electrical components, check the electrical wiring diagram.
- The electrical components are under high voltage by the operation of the booster capacitor.
Fully discharge the capacitor before commencing a repair work. Failure to observe this warning could result in electric shock.
- When parts of refrigerant cycle is disassembled by welding, be sure to work after collecting a refrigerant, if the refrigerant isn't collected, the unit might explode.
- Be sure to collect refrigerant without spreading it in the air.
- These contents are an example. Please refer to a similar part of actual unit.

PROCEDURE & PICTURES (FDTS series)

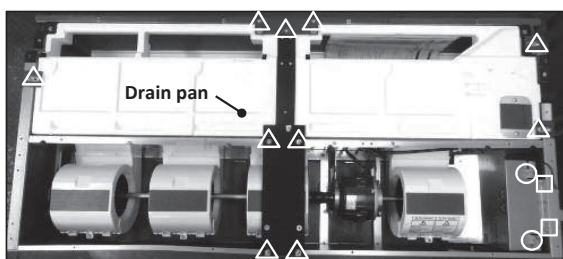

1. To remove the lid of control box
(1) Remove 2 lid fixing screws and remove it.(○ mark)

2. To remove the control box
(1) Remove the lid of control box.(See No.1)
(2) Pull off all the inserted connectors.
(3) Remove 2 control box fixing screws and remove it.(□ mark)

3. To remove the drain pan
(1) Remove 10 drain pan fixing screws and remove it.
(△ mark)

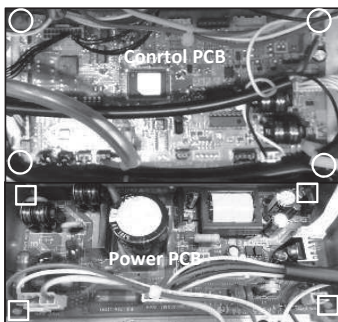

4. To remove the printed circuit board (PCB)
(1) Remove the lid of control box.(See No.1)
(2) Pull off all the inserted connectors.

- **Control PCB**
(3) Take off 4 control PCB fixing locking supports and remove it.(○ mark)
- **Power PCB**
(4) Take off 4 power PCB fixing locking supports and remove it.(□ mark)

5. To remove the impeller and motor (FM)
(1) Remove the lid of control box.(See No.1)
(2) Disconnect the motor connector(CNMx) on PCB in control box.
(3) Remove 2 motor fixings screw and remove it.(○ mark)
(4) Remove the fan casing fixing screw and remove it.(□ mark)
(5) Remove the impeller fixing bolt and remove it.(△ mark)

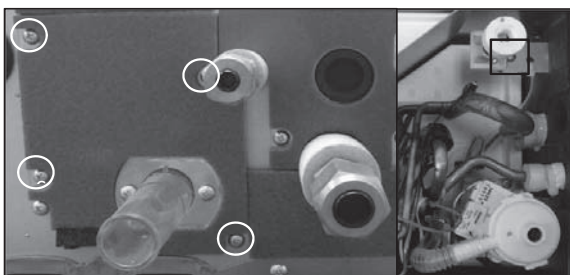
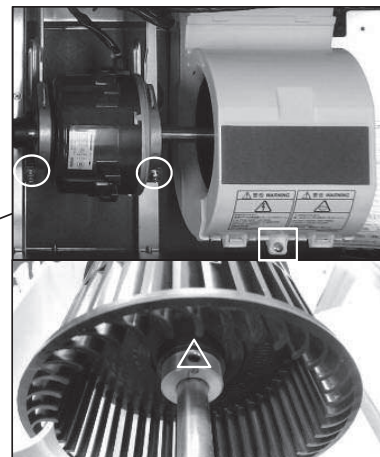

6. To remove the float switch (FS)
(1) Remove the lid of control box.(See No.1)
(2) Disconnect the float switch connector(CNI) on PCB in control box.
(3) Remove 4 drain pump assembly fixing screws and remove it.(○ mark)
(4) Remove the float switch fixing screw and remove it.(□ mark)

PROCEDURE & PICTURES

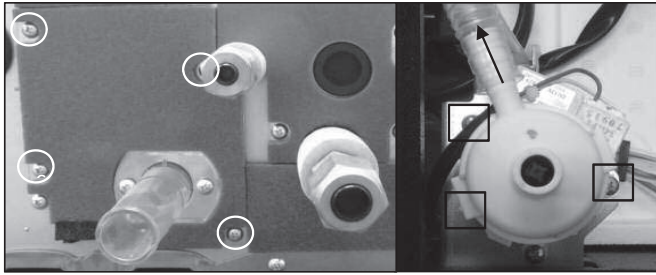

7. To remove drain pump (DM)

- (1) Remove the lid of control box.(See No.1)
- (2) Disconnect the drain pump connector(CNR) on PCB in control box.
- (3) Remove 4 drain pump assembly fixing screws and remove it.(○ mark)
- (4) Pull a hose to the arrow direction and remove it.
- (5) Remove 3 drain pump fixing screws and remove it.(□ mark)

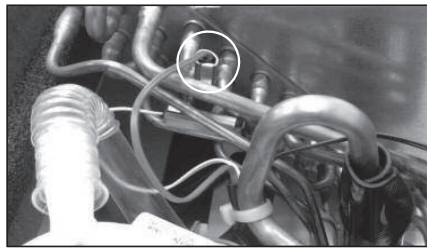

8. To remove the sensors (example"Thi-R1")

- (1) Remove the lid of control box.(See No.1)
- (2) Disconnect the Tho-R1 connector(CNNx) on PCB in control box.
- (3) Remove the drain pan.(See No.3)
- (4) Pull out the temperature sensor "Thi-R1" from the sensor holder.

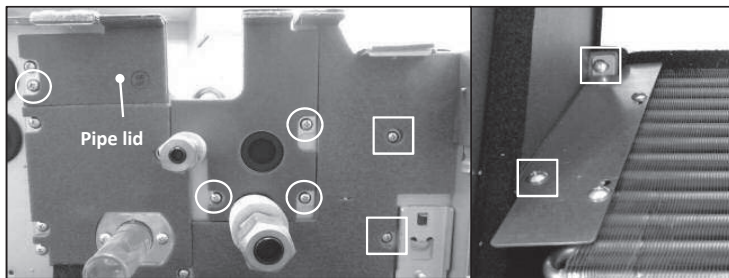

9. To remove the heat exchanger assembly

- (1) Remove the drain pan.(See No.3)
- (2) Remove 4 pipe lid fixing screws and remove it.(○ mark)
- (3) Remove 4 heat exchanger assy fixing screws and remove it.(□ mark)

10. To remove the electronic expansion Valve (EEV)

- (1) Remove the heat exchanger assembly. (See No.7)
- (2) Remove the coil of EEV by pull out on the top.
- (3) Remove welded part of EEV by welding. (○ mark)

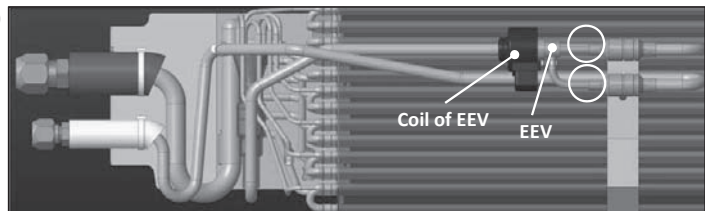

General view

DISASSEMBLY PROCEDURE

WARNING **Precautions for safety**

- Read these "Precautions for safety" carefully before starting disassembly work and do it in the proper way.
- When disassembling, be sure to turn off the power. When disassembling the electrical components, check the electrical wiring diagram.
- The electrical components are under high voltage by the operation of the booster capacitor.
Fully discharge the capacitor before commencing a repair work. Failure to observe this warning could result in electric shock.
- When parts of refrigerant cycle is disassembled by welding, be sure to work after collecting a refrigerant, if the refrigerant isn't collected, the unit might explode.
- Be sure to collect refrigerant without spreading it in the air.
- These contents are an example. Please refer to a similar part of actual unit.

PROCEDURE & PICTURES (FDU·FDUM series)

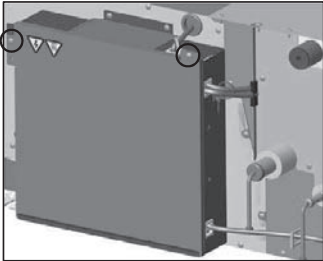

(Bottom)

1. To remove the lid of control box
(1) Remove 2 lid fixing screws and remove it.



(Top)

2. To remove the printed circuit board (PCB)
(1) Remove the lid of control box. (See No.1)
(2) Pull off all the inserted connectors.

- **Control PCB**
(3) Take off 4 control PCB fixing locking supports (○ mark) and remove it.
- **Power PCB**
(4) Take off 6 power PCB fixing locking supports (○ mark) and remove it.

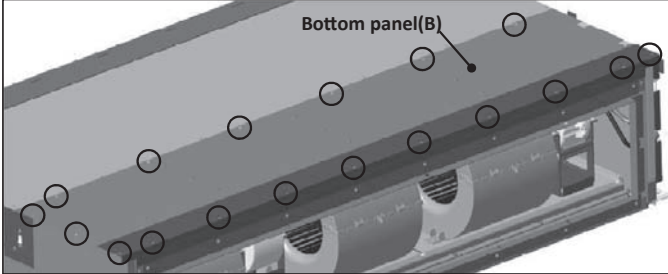

Bottom panel(B)

3. To remove the bottom panel(B)
(1) Remove 18 panel fixing screws and remove it.

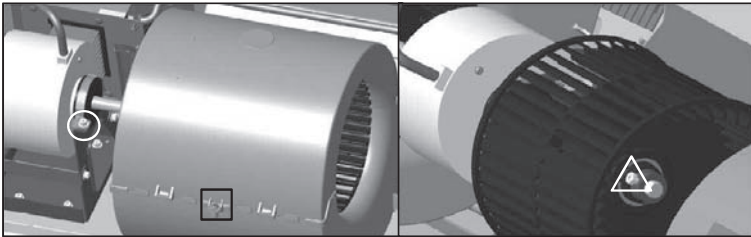

4. To remove the impellers and motors(FM)
(1) Remove the lid of control box. (See No.1)
(2) Remove the bottom panel(B). (See No.3)
(3) Disconnect the motor connector (CNFMx or CNMx) on PCB in control box.
(4) Remove the motor fixing screw and remove it. (○ mark/right and left side)
(5) Remove the fan casing fixing screw and remove it. (□ mark)
(6) Remove the sirocco fan fixing bolt and remove it. (△ mark)

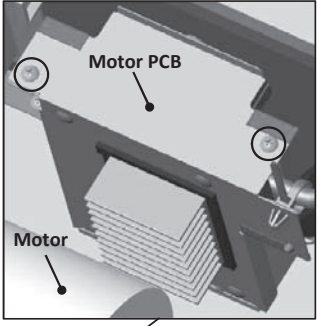

Motor PCB

Motor

5. To remove the motor PCB
(1) Remove the lid of control box. (See No.1)
(2) Remove the bottom panel(B). (See No.3)
(3) Disconnect the motor PCB connector (CNFMx or CNMx) on PCB in control box.
(4) Remove 2 motor PCB fixing screws and remove it.

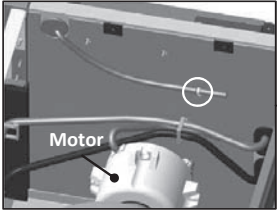

Motor

6. To remove the sensors (example "Thi-A")
(1) Remove the lid of control box. (See No.1)
(2) Remove the bottom panel(B). (See No.3)
(3) Disconnect the Thi-A connector (CNH) on PCB in control box.
(4) Pull the temperature sensor fixing clip and remove it. (○ mark)

PROCEDURE & PICTURES

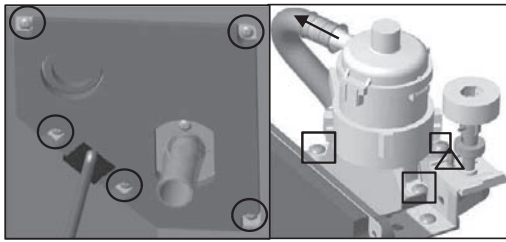

7. To remove the drain pump(DM) and float switch(FS)

- (1) Remove the lid of control box.(See No.1)
- (2) Remove 5 drain pump assembly fixing screws and remove it. (○ mark)
- (3) Disconnect the drain pump connector(CNR) on PCB in control box.
- (4) Pull a hose to the arrow direction and remove it.
- (5) Remove 3 drain pump fixing screws and remove it.(□ mark)
- (6) Disconnect the float switch connector(CNI) on PCB in control box.
- (7) Remove the float switch fixing screw and remove it.(△ mark)

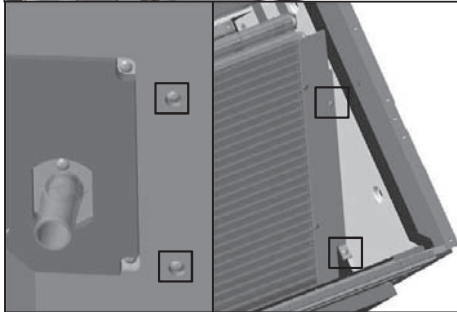
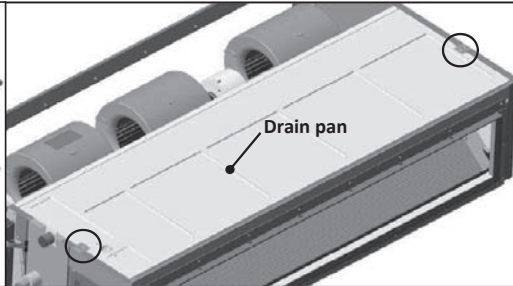
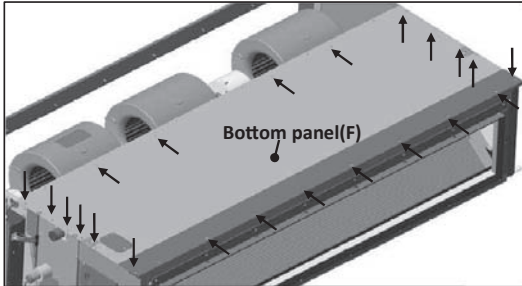

8. To remove the heat exchanger assembly

- (1) Remove the bottom panel(B).(See No.3)
- (2) Remove 22 bottom panel(F) fixing screws and remove it.(← mark)
- (3) Remove 2 drain pan fixing screws and remove it.(○ mark)
- (4) Remove 4 heat exchanger assy fixing screws and remove it.(□ mark)

9. To remove the Electronic Expansion Valve (EEV)

- (1) Remove the heat exchanger assembly.(See No.8)
- (2) Remove the coil of EEV by pull out on the top.
- (3) Remove welded part of EEV by welding.(○ mark)

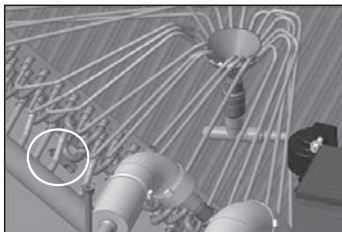
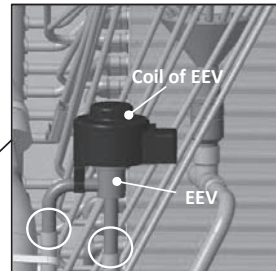

10. To remove the sensors (example "Thi-R3")

- (1) Remove the lid of control box.(See No.1)
- (2) Disconnect the Thi-R3 connector(CNN) on PWB in control box.
- (3) Remove the drain pan.(See No.8)
- (4) Pull out the temperature sensor "Thi-R3" from the sensor holder.



General view

DISASSEMBLY PROCEDURE

WARNING **Precautions for safety**

- Read these "Precautions for safety" carefully before starting disassembly work and do it in the proper way.
- When disassembling, be sure to turn off the power. When disassembling the electrical components, check the electrical wiring diagram.
- The electrical components are under high voltage by the operation of the booster capacitor.
Fully discharge the capacitor before commencing a repair work. Failure to observe this warning could result in electric shock.
- When parts of refrigerant cycle is disassembled by welding, be sure to work after collecting a refrigerant, if the refrigerant isn't collected, the unit might explode.
- Be sure to collect refrigerant without spreading it in the air.
- These contents are an example. Please refer to a similar part of actual unit.

PROCEDURE & PICTURES (FDUT series)

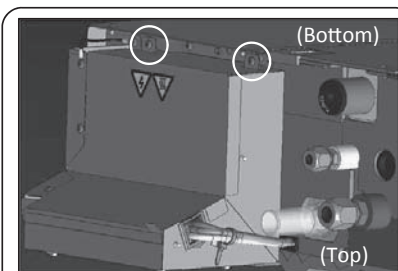

- 1. To remove the lid of control box**
(1) Remove 2 lid fixing screws and remove it.

- 3. To remove the bottom panel(B)**
(1) Remove 12 panel fixing screws and remove it.

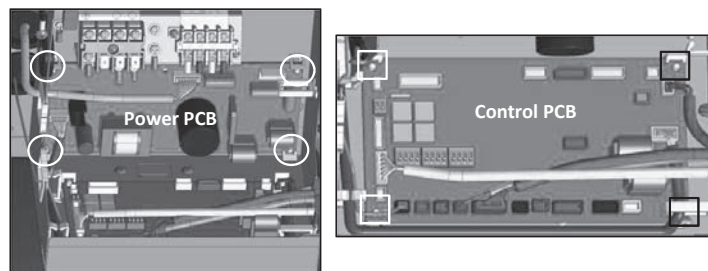

- 2. To remove the printed circuit board (PCB)**
(1) Remove the lid of control box.(See No.1)
(2) Pull off all the inserted connectors.
- **Control PCB**
(3) Take off 4 control PCB fixing locking supports and remove it. (□ mark)
 - **Power PCB**
(4) Take off 4 power PCB fixing locking supports and remove it. (○ mark)

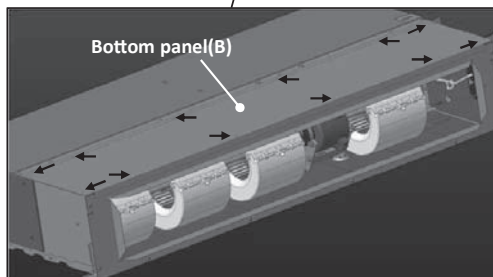

- 5. To remove the drain pan**
(1) Remove the bottom panel(B).(See No.3)
(2) Remove 18 bottom panel(F) fixing screws and remove it.(← mark)
(3) Remove 2 drain pan fixing screws and remove it.(○ mark)

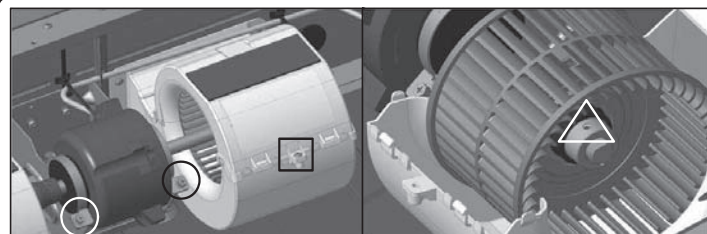

- 4. To remove the impellers and motors(FM)**
(1) Remove the lid of control box.(See No.1)
(2) Remove the bottom panel(B).(See No.3)
(3) Disconnect the motor connector(CNM1) on PCB in control box.
(4) Remove 2 motor fixing screws and remove it.(○ mark)
(5) Remove the fan casing fixing screw and remove it.(□ mark)
(6) Remove the sirocco fan fixing bolt and remove it.(△ mark)

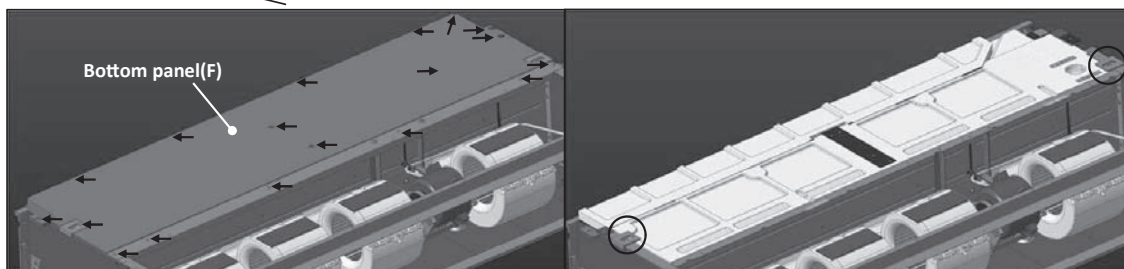

PROCEDURE & PICTURES

6. To remove the control box

- (1) Remove the lid of control box.(See No.1)
- (2) Pull off all the inserted connectors.
- (3) Remove 2 cotrol box fixing screws and remove it.

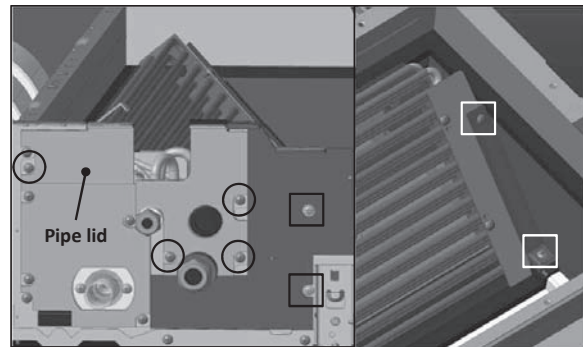
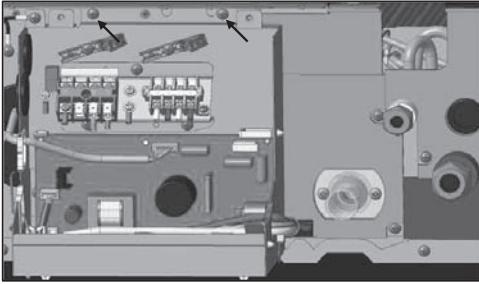

7. To remove the heat exchanger assembly

- (1) Remove the bottom panel(B).(See No.3)
- (2) Remove the drain pan.(See No.5)
- (3) Remove the control box.(See No.6)
- (4) Remove 4 pipe lid fixing screws and remove it.(○ mark)
- (5) Remove 4 heat exchanger assy fixing screws and remove it.(□ mark)

8. To remove the drain pump(DM) and float switch(FS)

- (1) Remove the control box.(See No.6)
- (2) Disconnect the drain pump connector(CNR) on PCB in control box.
- (3) Disconnect the float switch connector(CNI) on PCB in control box.
- (4) Remove 4 drain pump assembly fixing screws and remove it.(○ mark)
- (5) Pull a hose to the arrow direction and remove it.
- (6) Remove 3 drain pump fixing screws and remove it.(□ mark)
- (7) Remove the float switch fixing screw and remove it.(△ mark)

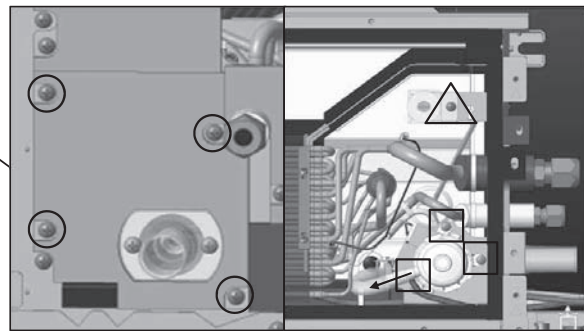

9. To remove the electronic expansion Valve (EEV)

- (1) Remove the heat exchanger assembly.(See No.7)
- (2) Remove the coil of EEV by pull out on the top.
- (3) Remove welded part of EEV by welding.(○ mark)

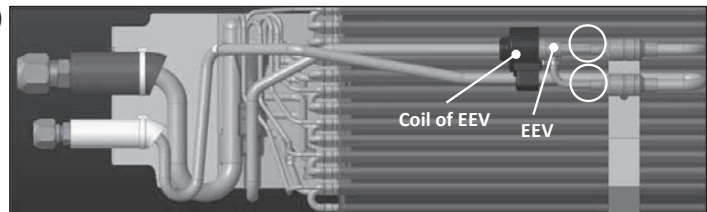

10. To remove the sensors (example "Thi-R1")

- (1) Remove the lid of control box.(See No.1)
- (2) Disconnect the Thi-R1 connector(CNN) on PWB in control box.
- (3) Remove the drain pan.(See No.5)
- (4) Pull out the temperature sensor "Thi-R3" from the sensor holder.

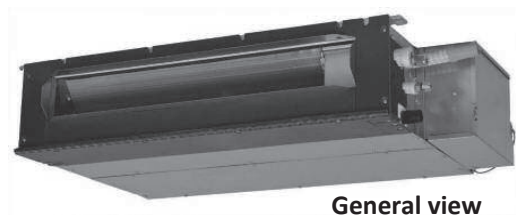
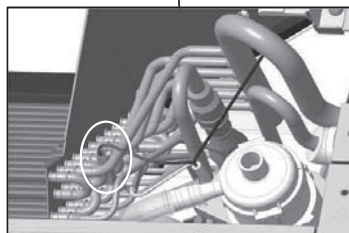

General view

DISASSEMBLY PROCEDURE

WARNING **Precautions for safety**

- Read these "Precautions for safety" carefully before starting disassembly work and do it in the proper way.
- When disassembling, be sure to turn off the power. When disassembling the electrical components, check the electrical wiring diagram.
- The electrical components are under high voltage by the operation of the booster capacitor.
Fully discharge the capacitor before commencing a repair work. Failure to observe this warning could result in electric shock.
- When parts of refrigerant cycle is disassembled by welding, be sure to work after collecting a refrigerant, if the refrigerant isn't collected, the unit might explode.
- Be sure to collect refrigerant without spreading it in the air.
- These contents are an example. Please refer to a similar part of actual unit.

PROCEDURE & PICTURES (FDUH series)

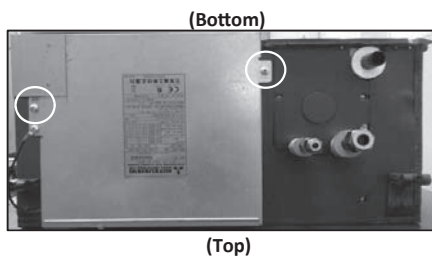

- 1. To remove the lid of control box**
(1) Remove 2 lid fixing screws and remove it.

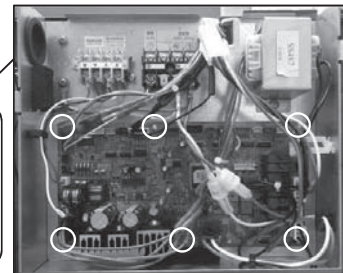

- 2. To remove the printed circuit board**
(1) Remove the lid of control box. (See No.1)
(2) Pull off all the inserted connectors.
(3) Take off 6 control PCB fixing locking supports and remove it.

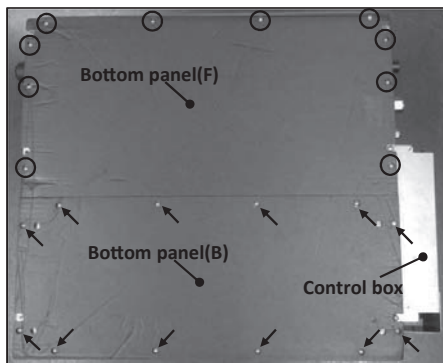

- 3. To remove the bottom panel(B) and bottom panel(F)**
(1) Remove 12 bottom panel panel(B) fixing screws and remove it. (→ mark)
(2) Remove 10 bottom panel panel(F) fixing screws and remove it. (○ mark)



- 4. To remove the drain pan.**
(1) Remove the bottom panel(B) and bottom panel(F). (See.No.3)
(2) Pull out the control box.

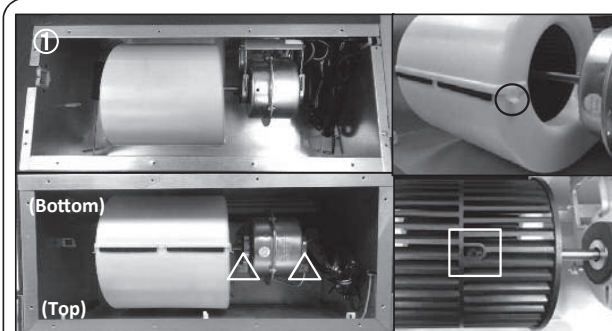

- 5. To remove the impeller and motor (FM)**
(1) Remove the lid of control box. (See No.1)
(2) Remove the bottom panel(B). (See No.2) <Pic. ①>
(3) Disconnect the motor connector(CNFx) in the middle of wiring.
(4) Take off the right and left hooks of the fan casing and remove it. (○ mark)
(5) Remove the impeller fixing bolt and remove it. (□ mark)
(6) Remove 2 motor fixing screws and remove it. (△ mark)

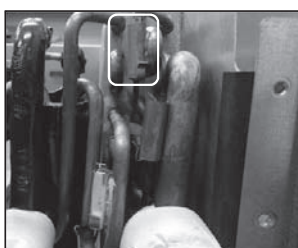

- 6. To remove the sensors (example "Thi-R1")**
(1) Remove the lid of control box. (See No.1)
(2) Disconnect the Tho-R1 connector(CNNx) on PCB in control box.
(3) Remove the drain pan. (See No.4)
(4) Pull out the temperature sensor "Thi-R1" from the sensor holder.

PROCEDURE & PICTURES

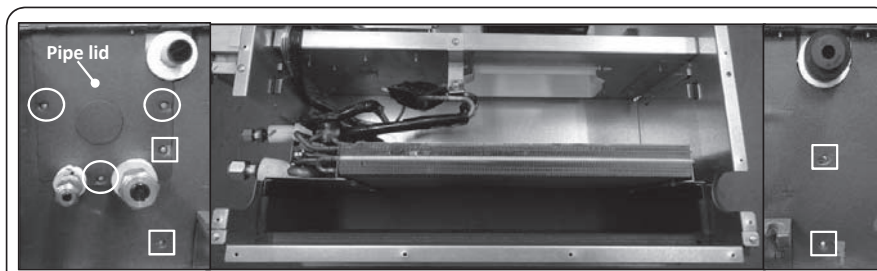

7. To remove the heat exchanger assembly

- (1) Remove the drain pan.(See No.3)
- (2) Remove 3 pipe lid fixing screws and remove it.(○ mark)
- (3) Remove 4 heat exchanger assy fixing screws and remove it.(□ mark)

8. To remove the Electronic Expansion Valve (EEV)

- (1) Remove the heat exchanger assembly.(See No.9)
- (2) Remove the coil of EEV by pull out on the top.
- (3) Remove welded part of EEV by welding.(○ mark)

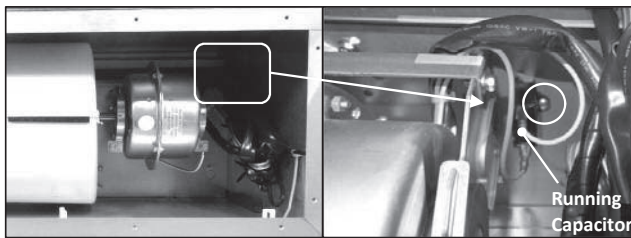
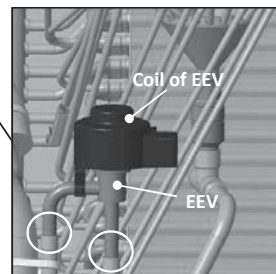

8. To remove the running capacitor of fan motor

- (1) Remove the running capacitor fixing screw and remove it.

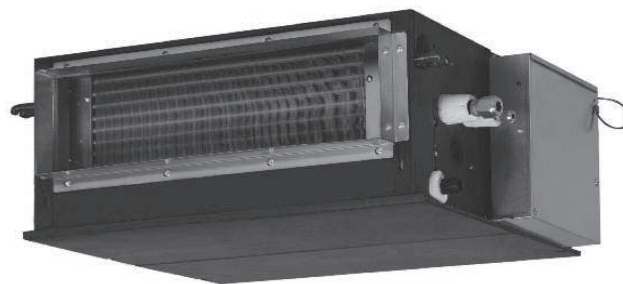

General view



DISASSEMBLY PROCEDURE

⚠ WARNING

Precautions for safety

- Read these "Precautions for safety" carefully before starting disassembly work and do it in the proper way.
- When disassembling, be sure to turn off the power. When disassembling the electrical components, check the electrical wiring diagram.
- The electrical components are under high voltage by the operation of the booster capacitor.
Fully discharge the capacitor before commencing a repair work. Failure to observe this warning could result in electric shock.
- When parts of refrigerant cycle is disassembled by welding, be sure to work after collecting a refrigerant, if the refrigerant isn't collected, the unit might explode.
- Be sure to collect refrigerant without spreading it in the air.
- These contents are an example. Please refer to a similar part of actual unit.

PROCEDURE & PICTURES (SRK-ZS,FDK series)

Item	Illustration	Operating procedure
①	<p style="text-align: center;">Air inlet panel</p> 	<p>[Removing the air inlet panel] 1. Hold lower edge of the air inlet panel, and then open it to about 80°.</p>
②	<p style="text-align: center;">Air filter</p>  <p style="text-align: center;">Air cleaning filter</p> 	<p>[Removing the filter] 1. Remove the air filter ×2. 2. Remove the air-cleaning filter ×2. 3. Holding both sides of the air inlet panel, pull the left and right sides forward at the same time to remove the panel.</p>

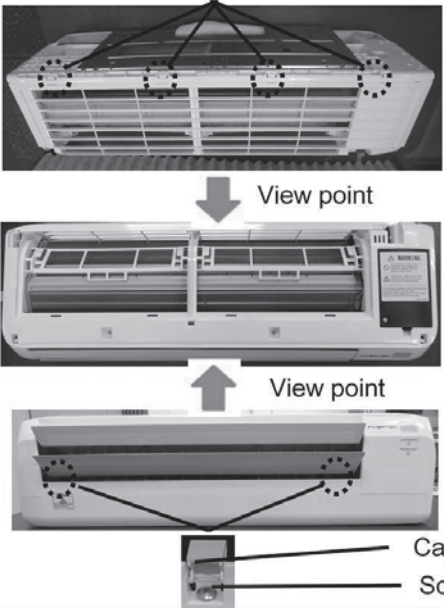
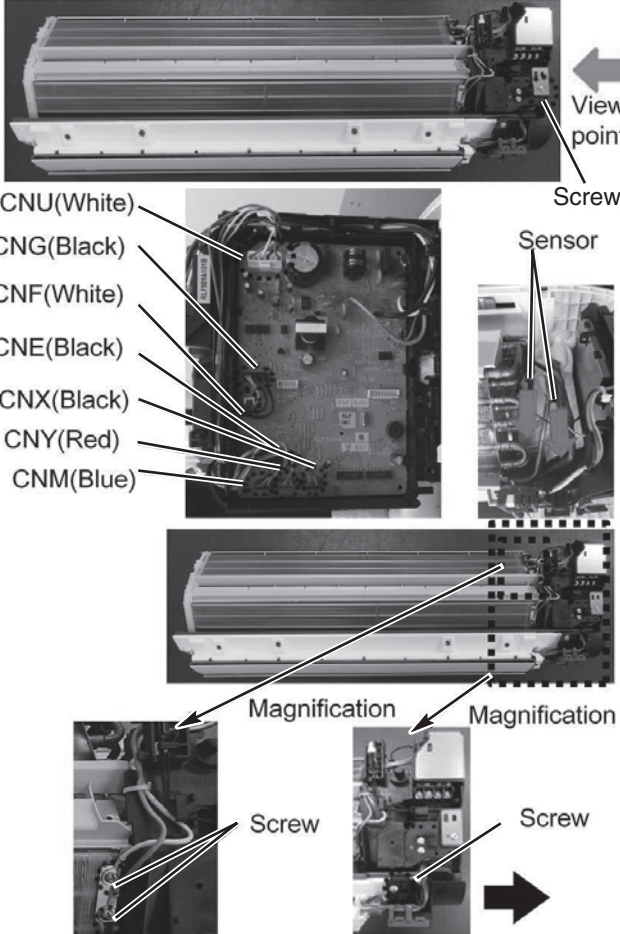
Item	Illustration	Operating procedure
<p style="text-align: center;">③</p> <p style="writing-mode: vertical-rl; transform: rotate(180deg);">Removing the front panel</p>	<p style="text-align: center;">Hook</p>  <p style="text-align: center;">View point</p> <p style="text-align: center;">View point</p> <p style="text-align: right;">Cap Screw</p>	<p>1. Open the caps, and then remove the screw ×2 (circled in the illustration below)</p> <p>2. Draw the front panel above after removing 4 hooks</p> <p>Caution</p> <ul style="list-style-type: none"> • Be sure to use a fine-tipped tool (such as a precision screwdriver) to open the cap. • Be careful not to damage the panel surface when opening the caps.
<p style="text-align: center;">④</p> <p style="writing-mode: vertical-rl; transform: rotate(180deg);">Removing the electrical control and peripheral parts</p>	 <p style="text-align: right;">View point</p> <p style="text-align: right;">Screw</p> <p>CNU(White)</p> <p>CNG(Black)</p> <p>CNF(White)</p> <p>CNE(Black)</p> <p>CNX(Black)</p> <p>CNY(Red)</p> <p>CNM(Blue)</p> <p style="text-align: center;">Sensor</p> <p style="text-align: center;">Magnification</p> <p style="text-align: center;">Magnification</p> <p style="text-align: center;">Screw</p> <p style="text-align: center;">Screw</p>	<p>[Removing the Control]</p> <p>1. Remove screw x1 so as to remove a metal lid.</p> <p>2. Remove a metal lid then unplug the following connector x7</p> <ul style="list-style-type: none"> CNU(White) CNG(Black) CNF(White) CNE(Black) CNX(Black) CNY(Red) CNW(Blue) <p>3. Pull the each sensor out from the case into the indicated directions in red arrows.</p> <p>4. Remove screw x3 then draw the controller toward right direction.</p>

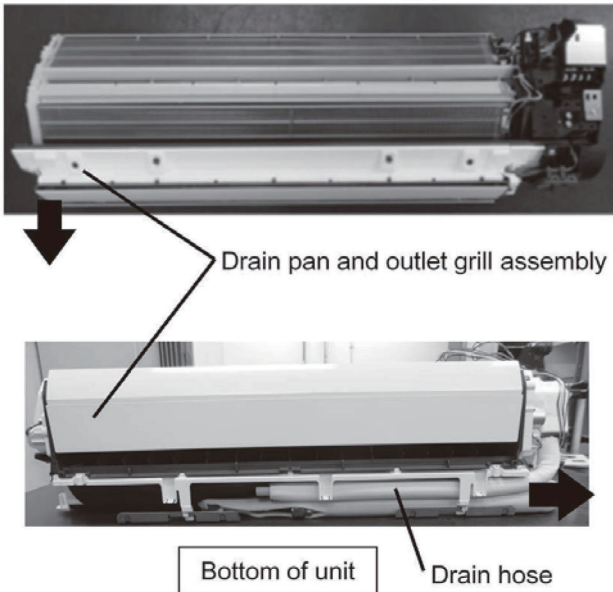
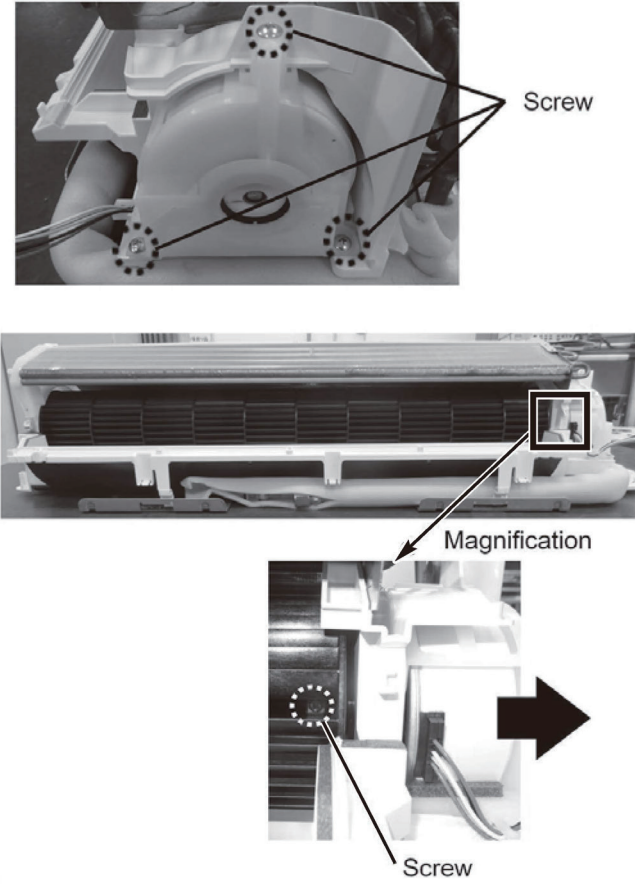
Item	Illustration	Operating procedure
<p style="text-align: center;">⑤</p> <p style="writing-mode: vertical-rl; transform: rotate(180deg);">Removing drain pan & outlet grill assembly</p>		<p>[Removing the drain pan]</p> <p>1. Draw the left of the drain pan and outlet grill assembly toward lower side so as to come off it from heat exchanger assembly.</p> <p>2. Draw the drain pan and outlet grill assembly toward the right with drawing the drain hose.</p>
<p style="text-align: center;">⑥</p> <p style="writing-mode: vertical-rl; transform: rotate(180deg);">Removing fan & motor</p>		<p>[Removing fan & motor]</p> <p>1. Remove screw x3</p> <p>2. Look into the area surrounded the black rectangle, adjust the screw position with rotating the cross flow fan, then remove a screw.</p> <p>3. Draw the motor and its bracket toward the right.</p>

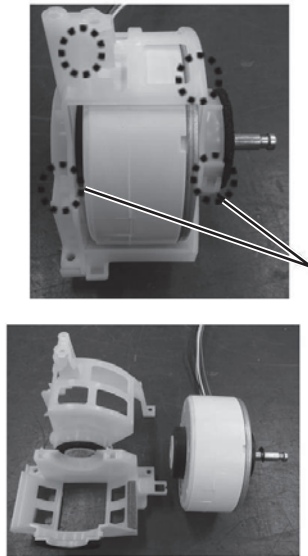
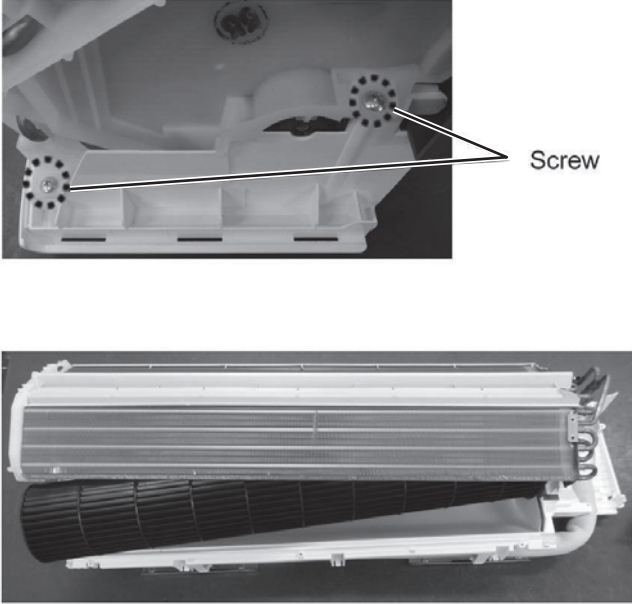
Item	Illustration	Operating procedure
<p style="text-align: center;">⑦</p> <p style="text-align: center;">Disassemble the motor</p>	 <p style="text-align: right;">Hook</p>	<p>[Removing the motor case] 1. Release the hook ×4 (circled in the illustration), and then remove the motor case (U).</p>
<p style="text-align: center;">⑧</p> <p style="text-align: center;">Removing the fan and heat exchanger</p>	 <p style="text-align: right;">Screw</p>	<p>1. Remove the screw ×2 (circled in the illustration) on the left side of the heat exchanger.</p> <p>2. While lifting up and supporting the left side of the heat exchanger, pull out the fan to the left, keeping it angled down.</p>

DISASSEMBLY PROCEDURE

WARNING Precautions for safety

- Read these "Precautions for safety" carefully before starting disassembly work and do it in the proper way.
- When disassembling, be sure to turn off the power. When disassembling the electrical components, check the electrical wiring diagram.
- The electrical components are under high voltage by the operation of the booster capacitor.
Fully discharge the capacitor before commencing a repair work. Failure to observe this warning could result in electric shock.
- When parts of refrigerant cycle is disassembled by welding, be sure to work after collecting a refrigerant, if the refrigerant isn't collected, the unit might explode.
- Be sure to collect refrigerant without spreading it in the air.
- These contents are an example. Please refer to a similar part of actual unit.

PROCEDURE & PICTURES (FDE series)

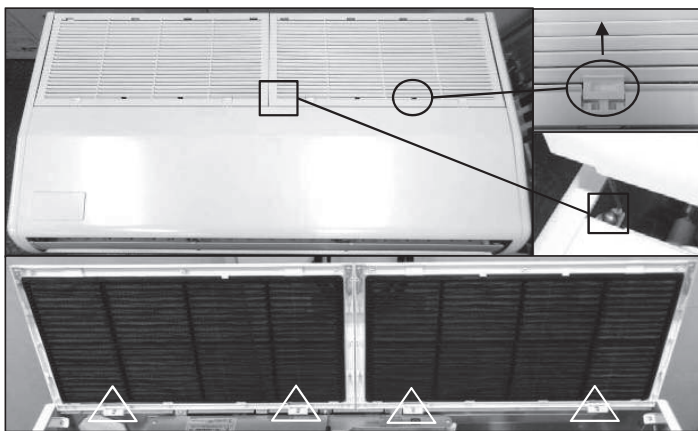

- 1. To remove air inlet grille.**
 - (1) Slide the hook in the direction of the arrow.(○ mark)
 - (2) Remove 4 wire fixing screws.(□ mark)
 - (3) Remove 4 air inlet grille fixing screws.(△ mark)

- 2. To remove the lid of control box**
 - (1) To remove air inlet grille.(See.No.1)
 - (2) Remove 2 wire fixing screws and remove it.(← mark)
 - (3) Remove 2 lid fixing screws and remove it.(○ mark)

- 3. To remove the control box**
 - (1) Remove the lid of control box.(See No.2)
 - (2) Pull off all the inserted connectors.
 - (3) Remove 2 control box fixing screws and remove it.(□ mark)
 - (4) Pull out the control box.

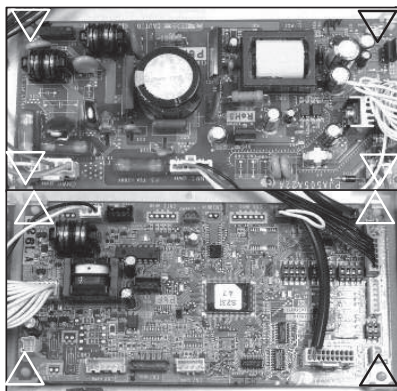

- 4. To remove the printed circuit board (PCB)**
 - (1) Remove the lid of control box.(See No.2)
 - (2) Pull off all the inserted connectors.
 - **Control PCB**
 - (3) Take off 4 control PCB fixing locking supports and remove it.(△ mark)
 - **Power PCB**
 - (4) Take off 4 power PCB fixing locking supports and remove it.(▽ mark)

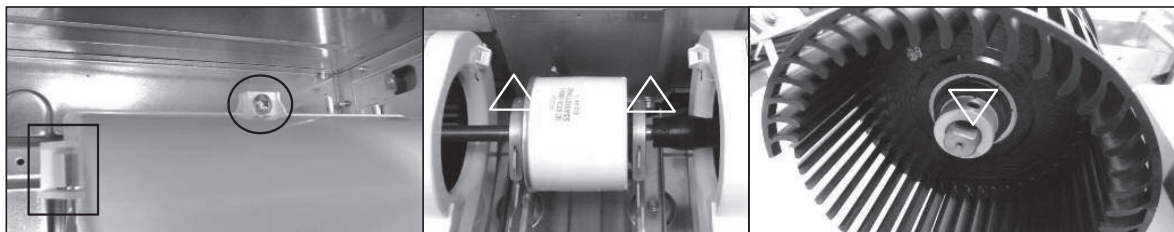

- 5. To remove the impeller and motor (FM)**
 - (1) Remove the lid of control box.(See No.1)
 - (2) Disconnect the motor connector(CNFx) in the middle way of wiring.
 - (3) Remove the fan casing fixing screw.(○ mark) Take off the fan casing fixing hook and remove it.(□ mark)
 - (4) Remove the impeller fixing screw and remove it.(▽ mark)
 - (5) Remove 2 motor fixing screws and remove it.(△ mark)

PROCEDURE & PICTURES

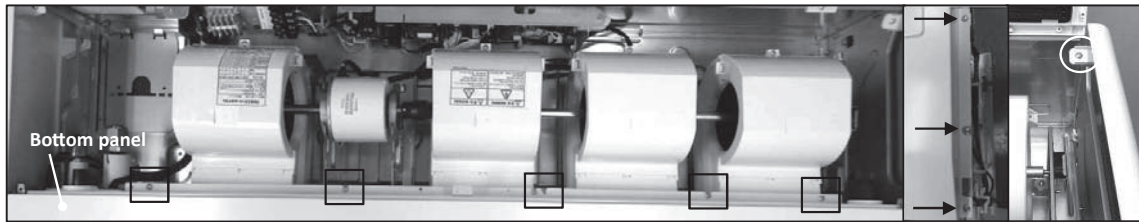

- 6. To remove side panel and bottom panel**
- (1) Remove air inlet grille.(See No.1)
 - (2) Remove the right and left side panel fixing screws and remove it.(○ mark)
 - (3) Remove 5 bottom panel fixing screws.(□ mark)
Remove 6 bottom panel fixing screws and remove it. (← mark, left and right side)

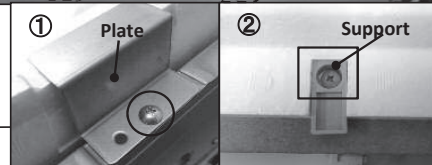

- 7. To remove drain pan**
- (1) Remove side panel and bottom panel.(See No.5)
 - (2) Remove 2 plate fixing screws and remove it.(○ mark, Pic.①)
 - (3) Remove 2 support fixing screws and remove it.(□ mark, Pic.②)
 - (4) Pull out the drain pan.

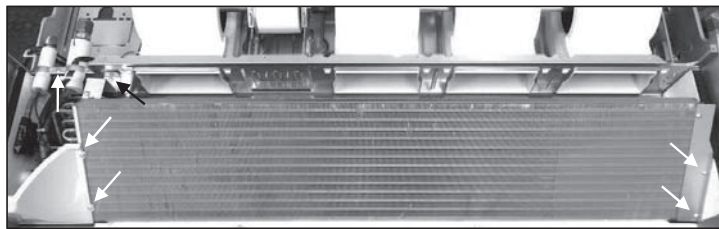

- 8. To remove the heat exchanger assembly**
- (1) Remove the drain pan.(See No.6)
 - (2) Remove 6 heat exchanger assy fixing screws and remove it.(← mark)

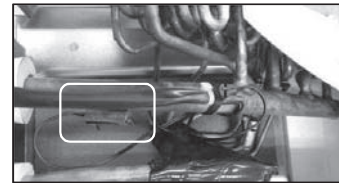

- 9. To remove the louver motor (LM)**
- (1) Remove the lid of control box.(See No.1)
 - (2) Disconnect the louver motor connector (CNJ) on PCB in control box.
 - (3) Remove side panel.(See No.5)
 - (4) Remove 2 louver motor fixing screws and remove it.

- 10. To remove the sensors (example "Thi-R3")**
- (1) Remove the lid of control box.(See No.1)
 - (2) Disconnect the Tho-R3 connector(CNNx) on PCB in control box.
 - (3) Remove the drain pan.(See No.3)
 - (4) Pull out the temperature sensor "Thi-R1" from the sensor holder.

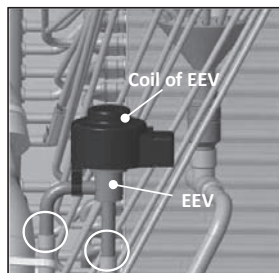

- 11. To remove the Electronic Expansion Valve (EEV)**
- (1) Remove the heat exchanger assembly.(See No.9)
 - (2) Remove the coil of EEV by pull out on the top.
 - (3) Remove welded part of EEV by welding.(○ mark)



General view

DISASSEMBLY PROCEDURE

WARNING Precautions for safety

- Read these "Precautions for safety" carefully before starting disassembly work and do it in the proper way.
- When disassembling, be sure to turn off the power. When disassembling the electrical components, check the electrical wiring diagram.
- The electrical components are under high voltage by the operation of the booster capacitor.
Fully discharge the capacitor before commencing a repair work. Failure to observe this warning could result in electric shock.
- When parts of refrigerant cycle is disassembled by welding, be sure to work after collecting a refrigerant, if the refrigerant isn't collected, the unit might explode.
- Be sure to collect refrigerant without spreading it in the air.
- These contents are an example. Please refer to a similar part of actual unit.

PROCEDURE & PICTURES (FDFW series)

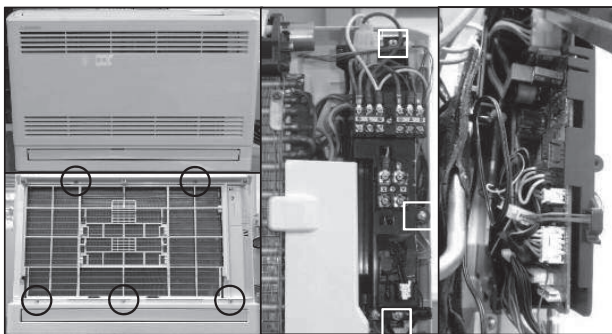

1. To remove the control box

- (1) Remove hooks of the front panel and remove it.
- (2) Remove 5 filter assembly fixing screws and remove it.(○ mark)
- (3) Remove 3 control box and lid fixing screws, and remove it.(□ mark)
- (4) Pull the control box forward.

2. To remove the lower flap motor (LFM)

- (1) Remove the control box.(See No.1)
- (2) Disconnect the lower flap motor connector(CNJ3) in the way of wiring.
- (3) Remove the cover fixing screw and remove it.(○ mark)
- (4) Remove 2 lower flap motor screws and remove it.(□ mark)

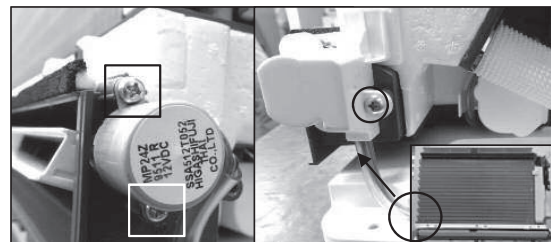

3. To remove the upper flap motor (UFM)

- (1) Remove the control box.(See No.1)
- (2) Disconnect the upper flap motor connector(CNJ4) in the way of wiring.
- (3) Remove 2 upper flap motor fixing screws and remove it.(□ mark)

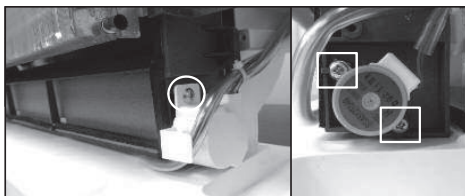

4. To remove drain pan

- (1) Remove the lower flap motor.(See No.3)
- (2) Remove 3 drain pan fixing screws and remove it.(○ mark)

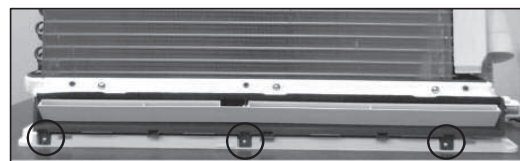

5. To remove the damper arm motor (DAM)

- (1) Remove the control box.(See No.1)
- (2) Disconnect the damper arm motor connector(CNJ2) in the way of wiring.
- (3) Remove the cover fixing screw and remove it.(○ mark)
- (4) Remove 2 damper arm motor fixing screws and remove it.(□ mark)

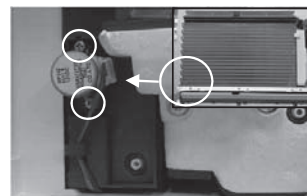

6. To remove the damper motor (DM)

- (1) Remove the control box.(See No.1)
- (2) Disconnect the damper motor connector(CNJ1) in the way of wiring.
- (3) Remove 2 damper arm motor fixing screws and remove it.(○ mark)

PROCEDURE & PICTURES

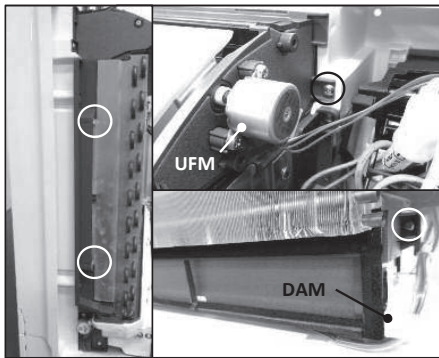

- 7. To remove the heat exchanger assembly**
 (1) Remove the drain pan.(See No.4)
 (2) Remove 4 heat exchanger assy fixing screws and remove it.(O mark)

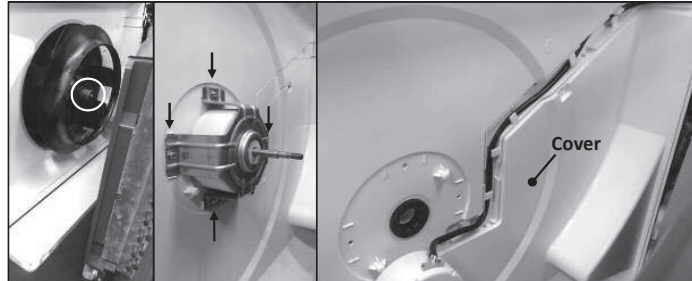

- 8. To remove the impeller and motor (FM)**
 (1) Remove control box.(See No.1)
 (2) Disconnect the motor connector(CNM) on PCB in control box.
 (3) Remove the heat exchanger assembly.(See No.7)
 (4) Remove the impeller fixing nut and remove it.(O mark)
 (5) Remove 4 motor fixing bolts and remove it.(← mark)
 (6) Take off the hooks of cover and remove it.

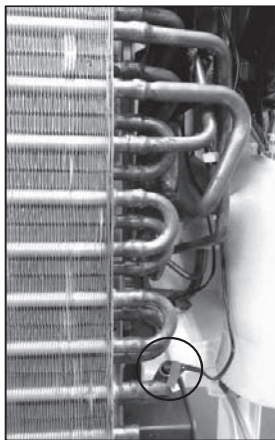

- 9. To remove the sensors (example"Thi-R1")**
 (1) Remove control box.(See No.1)
 (2) Disconnect the Tho-R1 connector(CNN) on PCB in control box.
 (3) Pull out the temperature sensor "Thi-R1" from the sensor holder.

- 10. To remove the Electronic Expansion Valve (EEV)**
 (1) Remove the heat exchanger assembly.(See No.7)
 (2) Remove the coil of EEV by pull out on the top.
 (3) Remove welded part of EEV by welding.(O mark)

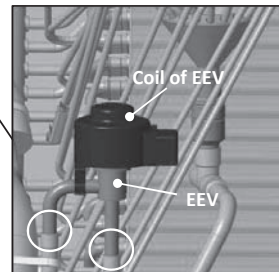

General view

DISASSEMBLY PROCEDURE

WARNING **Precautions for safety**

- Read these "Precautions for safety" carefully before starting disassembly work and do it in the proper way.
- When disassembling, be sure to turn off the power. When disassembling the electrical components, check the electrical wiring diagram.
- The electrical components are under high voltage by the operation of the booster capacitor.
Fully discharge the capacitor before commencing a repair work. Failure to observe this warning could result in electric shock.
- When parts of refrigerant cycle is disassembled by welding, be sure to work after collecting a refrigerant, if the refrigerant isn't collected, the unit might explode.
- Be sure to collect refrigerant without spreading it in the air.
- These contents are an example. Please refer to a similar part of actual unit.

PROCEDURE & PICTURES (FDFU • FDFL series)



1. To remove the lid of control box
(1) Remove 2 lid fixing screws and remove it.

2. To remove the printed circuit board (PCB)
(1) Remove the lid of control box. (See No.1)
(2) Pull off all the inserted connectors.
(3) Take off 6 power PCB fixing locking supports and remove it.

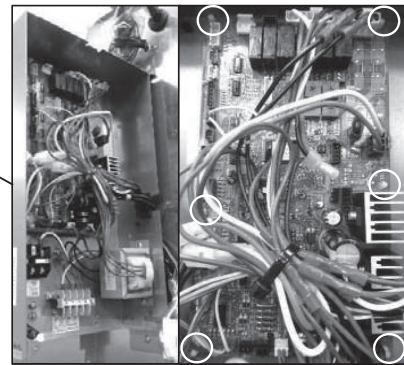

3. To remove the front panel (FDFU)
(1) Remove 8 front panel fixing screws and remove it.

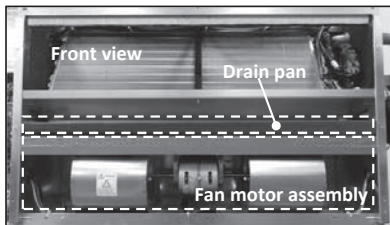
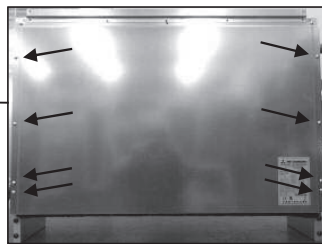

4. To remove the impeller and motor (FM)
(1) Remove the lid of control box. (See No.1), remove the front panel. (See No.3)
(2) Disconnect the motor connector (CNF1) in the way of wiring.
(3) Pull drain pan in the direction of the arrow and remove. (Pic.①)
(4) Remove 4 fan base fixing screws and remove fan motor assembly. (○ mark)
(5) Remove the impeller fixing bolt and remove it. (□ mark)
(6) Remove 2 motor fixing screws and remove it. (△ mark)

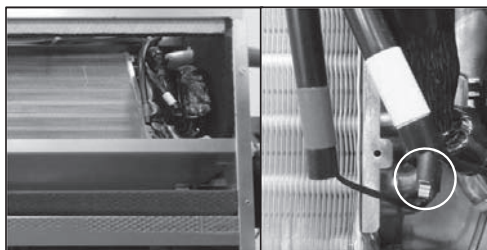
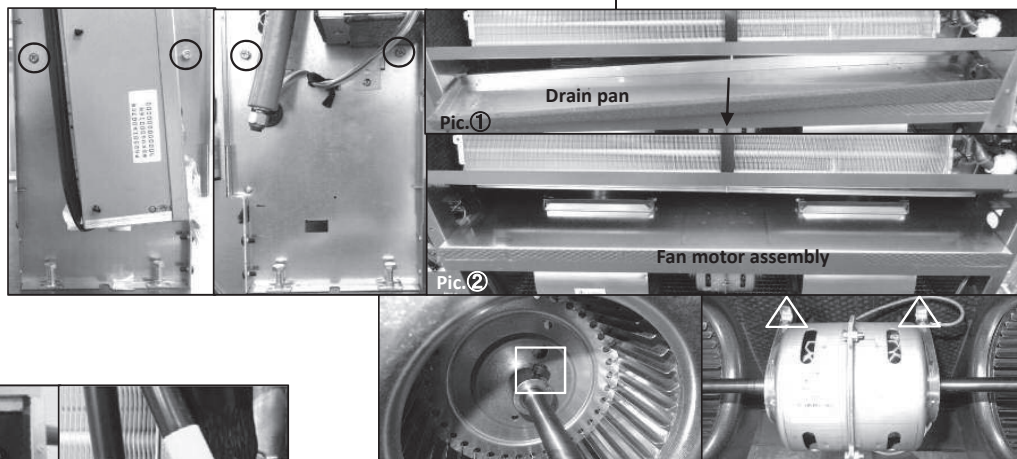

5. To remove the sensors (example "Thi-R1")
(1) Remove the lid of control box. (See No.1)
(2) Disconnect the Tho-R1 connector (CNNx) in the way of wiring.
(3) Remove the front panel. (See No.3)
(4) Pull out the temperature sensor "Thi-R1" from the sensor holder.

PROCEDURE & PICTURES

6. To remove the heat exchanger assembly

- (1) Remove 9 top panel fixing screws and remove it .(Pic.①②)
- (2) Remove 2 support fixing screws and remove it .(Pic.③)
- (3) Remove the lid of EEV box fixing screw and remove it.(□ mark, Pic.④)
Remove 3 EEV box fixing screws and remove it.(○ mark, Pic.④)
- (4) Remove 2 screws on the left side panel.(Pic.⑤)
- (5) Remove 3 screws on the back side panel.(Pic.⑥)
- (6) Remove 4 screws on the right side panel and pull the heat exchanger assembly to the right. (Pic.⑦)

7. To remove the running capacitor of fan motor

- (1) Remove the fan motor assembly.
(See No.4)
- (2) Remove faston terminal.
- (3) Remove the running capacitor fixing screw and remove it.

8. To remove the Electronic Expansion Valve (EEV)

- (1) Remove the heat exchanger assembly.(See No.9)
- (2) Remove the coil of EEV by pull out on the top.
- (3) Remove welded part of EEV by welding.(○ mark)

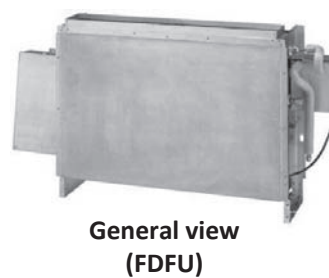

DISASSEMBLY PROCEDURE

WARNING

Precautions for safety

- Read these "Precautions for safety" carefully before starting disassembly work and do it in the proper way.
- When disassembling, be sure to turn off the power. When disassembling the electrical components, check the electrical wiring diagram.
- The electrical components are under high voltage by the operation of the booster capacitor.
Fully discharge the capacitor before commencing a repair work. Failure to observe this warning could result in electric shock.
- When parts of refrigerant cycle is disassembled by welding, be sure to work after collecting a refrigerant, if the refrigerant isn't collected, the unit might explode.
- Be sure to collect refrigerant without spreading it in the air.
- These contents are an example. Please refer to a similar part of actual unit.

PROCEDURE & PICTURES (SAF-DX series)



- 1. To remove the lid of control box**
(1) Remove 2 lid fixing screws and remove it.

- 2. To remove the printed circuit board (PCB)**
(1) Remove the lid of control box.(See No.1)
(2) Pull off all the inserted connectors.
(3) Take off 6 PCB fixing locking supports(○ mark)

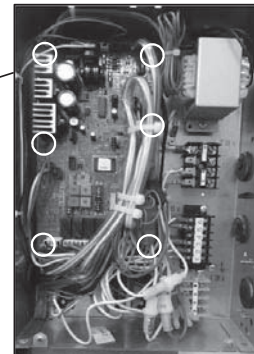

- 3. To remove the drain pan**
(1) Remove 10 bottom panel fixing screws and remove it.
(2) Pull the drain pan and remove it.

- 4. To remove the heat exchanger assembly**
(1) Remove the bottom panel(See No.3)
(2) Remove 4 fixing screws on the attached plate of heat exchanger and remove it.

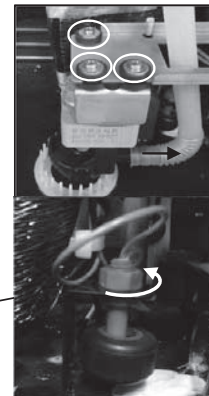

- 5. To remove the drain pump(DM) and float switch(FS)**
(1) Remove the lid of control box.(See No.1)
(2) Remove the drain pan.(See No.3)
(3) Disconnect the drain pump connector(CNRx) in the middle of wiring.
(4) Disconnect the float switch connector(CNlx) in the middle of wiring.
(5) Pull a hose to the arrow direction and remove it.
(6) Remove 3 drain pump fixing screws and remove it.(○ mark)
(7) Turn float switch to the left and remove it.

- 6. To remove the Electronic Expansion Valve (EEV)**
(1) Remove the heat exchanger assembly.(See No.8)
(2) Remove the coil of EEV by pull out on the top.
(3) Remove welded part of EEV by welding.(○ mark)

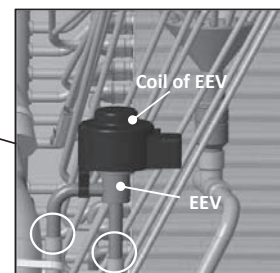

- 7. To remove the sensors, (example"Thi-R3")**
(1) Remove the drain pan.(See No.3)
(2) Pull out the temperature sensor "Thi-R3" from the sensor holder.

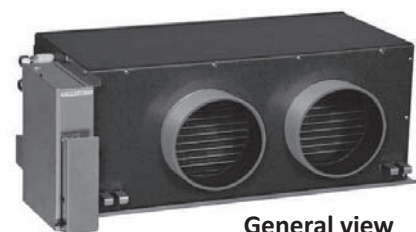

General view

DISASSEMBLY PROCEDURE



Precautions for safety

- Read these "Precautions for safety" carefully before starting disassembly work and do it in the proper way.
- When disassembling, be sure to turn off the power. When disassembling the electrical components, check the electrical wiring diagram.
- The electrical components are under high voltage by the operation of the booster capacitor.
Fully discharge the capacitor before commencing a repair work. Failure to observe this warning could result in electric shock.
- These contents are an example. Please refer to a similar part of actual unit.

PROCEDURE & PICTURES

FDT series

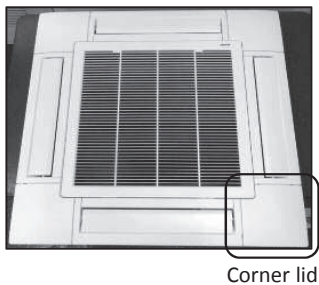

- 1. To remove the corner lid**
 - (1) Remove the inlet grille.
 - (2) Pull the corner lid toward the direction

(The four corner lids are the same way.)

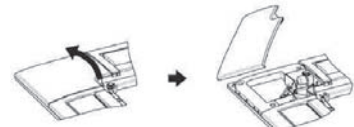

- 2. To remove the louver motor (LM)**
 - (1) Remove the corner lid.(See No.1)
 - (2) Remove the louver motor fixing screw and remove it.(□ mark)
- 3. To remove anti draft motor (AM)**
 - (1) Remove the corner lid.(See No.1)
 - (2) Remove 2 gear box fixing screws and remove it.(O mark)

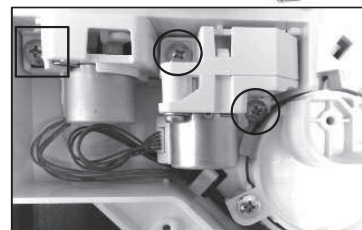

FDTC series

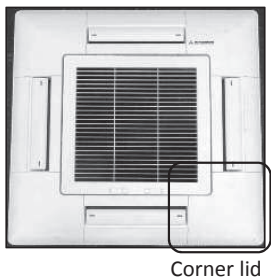

- 1. To remove the corner lid**
 - (1) Remove the inlet grille.
 - (2) Remove the screw(← mark), pull the corner lid toward the direction indicated by the arrow mark.

(The four corner lids are the same way.)



- 2. To remove the louver motor (LM)**
 - (1) Remove the corner lid.(See No.1)
 - (2) Remove 2 louver motor fixing screws and remove it.(□ mark)

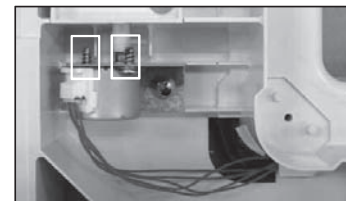

FDTs·FDTQ series

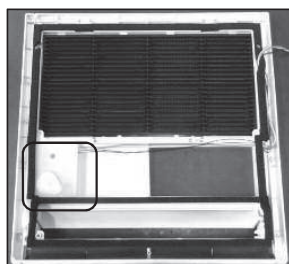

- 1. To remove the louver motor (LM)**
 - (1) Remove the cover fixing screw and remove it.(O mark)
 - (2) Remove the cam fixing screw and remove it.(□ mark)
 - (3) Remove 2 louver motor fixing screws and remove it.(△ mark)
- 2. To remove the limit switch (LS)**
 - (1) Remove the cover fixing screw and remove it.(O mark)
 - (2) Remove 2 limit switch fixing screws and remove it.(← mark)

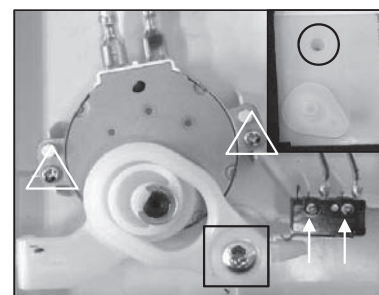

FDTW series

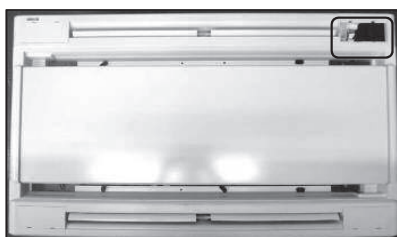

- 1. To remove the corner lid**
 - (1) Take off the corner panel fixing hooks by a flathead screwdriver and remove it.
- 2. To remove the louver motor (LM)**
 - (1) Remove the corner lid.(See No.1)
 - (2) Remove 2 louver motor fixing screws and remove it.(O mark)

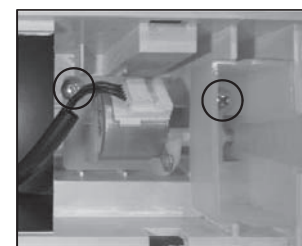

VRF INVERTER MULTI-SYSTEM AIR-CONDITIONERS



mitsubishi heavy industries thermal systems, ltd.

16-5 Konan 2-chome, Minato-ku, Tokyo, 108-8215, Japan
<http://www.mhi-mth.co.jp/en/>

Because of our policy of continuous improvement, we reserve the right to make changes in all specifications without notice.

© Copyright MITSUBISHI HEAVY INDUSTRIES THERMAL SYSTEMS, LTD.