

# Air to Water Heat Pump

---

## User manual

Wired remote controller MWR-WW10N / Control Kit MIM-E03CN

---

- Thank you for purchasing this Samsung Product.
- Before operating this unit, please read this user manual carefully and retain it for future reference.



**SAMSUNG**

# Contents

---

<b>Safety Information</b>	4
Safety Information	4
<b>Power Smart Features</b>	6
Remote Controller Operation	6
Operating basic mode • Domestic Hot Water (DHW) mode • Adjusting desired temperature • Setting the set temperature	
<b>Power Smart Features</b>	9
Operation status • Quiet mode • Outing mode	
<b>Energy-Saving Operation</b>	10
Energy-Saving Operation	10
Setting schedule • Energy • TDM (Time-Division Multi) Variables (TDM product Only)	
<b>Setting Options</b>	13
Setting Options	13
How to set the Options • Current Time Setting (Example)	
<b>Installation/Service mode</b>	16
Installation/Service mode	16
Additional functions of the Wired Remote Controller • Installation/Service mode • How to upload or download field settings (example)	

<b>Field Setting Mode</b>	<b>24</b>
<hr/>	
Field setting mode	24
Field Setting Value (FSV) 10** •	
Remote Controller Setting Range: Code 10** • Field Setting Value (FSV) 20** •	
Water Law & Room Thermostat/ Wired remoted controller: Code 20** •	
Field Setting Value (FSV) 30** • DHW Heating : Code 30** • Field Setting Value (FSV) 40** •	
Additional heating option : 40** • Field Setting Value (FSV) 50** • Others : Code 50** •	
PV Control (Photovoltaics control) • Smart Grid Control	
<b>Appendix</b>	<b>44</b>
<hr/>	
Maintaining the Unit	44
Maintenance activities • Emergency heating / Emergency hot water supply	
Troubleshooting tips	46
Communication • Water pump & Flow Sensor	
Error codes	49



***Correct Disposal of This Product  
(Waste Electrical & Electronic Equipment)***

***(Applicable in countries with separate collection systems)***

This marking on the product, accessories or literature indicates that the product and its electronic accessories (e.g. charger, headset, USB cable) should not be disposed of with other household waste at the end of their working life. To prevent possible harm to the environment or human health from uncontrolled waste disposal, please separate these items from other types of waste and recycle them responsibly to promote the sustainable reuse of material resources.

Household users should contact either the retailer where they purchased this product, or their local government office, for details of where and how they can take these items for environmentally safe recycling. Business users should contact their supplier and check the terms and conditions of the purchase contract. This product and its electronic accessories should not be mixed with other commercial wastes for disposal.

For information on Samsung's environmental commitments and product-specific regulatory obligations, e.g. REACH, WEEE, Batteries, visit : [samsung.com/uk/aboutsamsung/samsungelectronics/corporatecitizenship/data\\_corner.html](https://samsung.com/uk/aboutsamsung/samsungelectronics/corporatecitizenship/data_corner.html)

# Safety Information

---

This content is intended to protect the user's safety and prevent property damage. Please read it carefully for correct use of the product.

## WARNING

Hazards or unsafe practices that may result in severe personal injury or death.

## CAUTION

Hazards or unsafe practices that may result in minor personal injury or property damage.

 Follow directions.

 Do NOT attempt.

 Make sure the machine is grounded to prevent electric shock.

 Unplug the appliance.

 Do NOT disassemble.

## FOR INSTALLATION

---

### WARNING

 **The installation of this appliance must be performed by a qualified technician or service company.**

- Failing to do so may result in electric shock, fire, explosion, problems with the product, or injury.

**You must connect the product with rated power upon installation.**

- Failing to do so may result in problems with the product, electric shock, or fire.

 **Do not install this appliance near a heater, inflammable material. Do not install this appliance in a humid, oily or dusty location, in a location exposed to direct sunlight and water (rain drops). Do not install this appliance in a location where gas may leak.**

- Failing to do so may result in electric shock or fire.

### CAUTION

 **Install the product on a hard and even place that can support its weight.**

- If the place cannot support its weight, the product may fall down and it may cause product damage.

## FOR POWER SUPPLY

---

### WARNING

 **Do not bend or pull the power cord excessively. Do not twist or tie up the power cord.**

- Failing to do so may result in electric shock or fire.

---

## FOR OPERATION

---



### WARNING



If the appliance generates a strange noise, a burning smell or smoke, unplug the product immediately and contact your nearest service centre.

- Failing to do so may result in electric shock or fire.

To reinstall the product, please contact your nearest service centre.

- Failing to do so may result in problems with the product, water leakage, electric shock, or fire.
- A delivery service for the product is not provided. If you reinstall the product in another location, additional construction expenses and an installation fee will be charged.

If the malfunction diagnosis indicator appears or malfunctions, then stop operation immediately.

- If you detect any burning smells from the product or it malfunctions, then immediately turn off the product and power, and then contact the service centre. Continuing to use the device in this state can cause electrical shock, fire, or damage to the product.



Do not attempt to repair, disassemble, or modify the product yourself.

- Failing to do so may result in electric shock, fire, product malfunction, or injury.



### CAUTION



Do not allow water to enter the product.

- Failing to do so may result in fire or explosion.



Do not operate the product with wet hands.

- Failing to do so may result in electric shock.

Do not spray volatile material such as insecticide onto the surface of the product.

- As well as being harmful to humans, it may also result in electric shock, fire, or product malfunction.

Do not give a strong impact to the product and do not disassemble the product.

Do not use this product for other purposes.

Do not press the buttons with any sharp objects.

- Failing to do so may result in electric shock or part damage.

---

## FOR CLEANING

---



### WARNING



Do not clean the product by spraying water directly onto it. Do not use benzene, thinner, alcohol or acetone to clean the product.

- Failing to do so may result in discoloration, deformation, damage, electric shock, or fire.



# Remote Controller Operation

---

Operate the product by using the remote controller.

## Operating basic mode

---

Press the **OK** button to enter the Setting screen from the Home screen with the Zone 1 or Zone 2 activated. On each screen, press the **OK** and then press the  or  button to select any of Auto, Cool, and Heat modes.

### Auto mode

---

Hydro unit will automatically adjust the temperature of discharge water with the Auto mode for indoor heating.

#### **NOTE**

- When Water Law is active, the target supply water temperature will be determined automatically depending on the outdoor temperature: For the Heat mode, colder outdoor temperatures will result in warmer water.

### Cool mode

---

You can adjust cooling temperature as you like with the Cool mode to cool indoor place.

- When selecting the Heat mode during the Cool mode, the Cool mode will be canceled.

### Heat mode

---

Floor heating is available with the Heat mode by providing hot water in the spring, autumn and winter.

- You can check the Defrost Operation on the operation status menu under Option.
- When selecting the Cool mode during the Heat mode, the Heat mode will be canceled.

#### **NOTE**

- When setting standard cooling & heating temperature as indoor temperature, the Auto mode cannot be selected.

---

## Domestic Hot Water (DHW) mode

---

Press the **OK** button to enter the Setting screen from the Home screen with the DHW activated. On each screen, press the **OK** and then press the  $\wedge$  or  $\vee$  button to select and use any of Economic, Standard, Power, and Forced modes.

### **NOTE**

- When the DHW mode is not supported, "Not Supported" appears.
- To operate hot water mode, you need to set the hot water function 'Yes' in the field specification setting mode (#3011) of wired remote controller and connect the temperature sensor of hot water tank.
- When the Cool/Heat mode and the DHW mode are selected at the same time, the Cool/Heat mode and the DHW mode will operate alternately.
-  (power) for the DHW mode cannot be used when the Booster heater is not in use.
- If you want to enjoy a leisurely bath or need a lot of warm water urgently, select the Forced mode. When this mode is enabled, it is assured that the full capacity of the heat pump is only delivered for domestic water heating.

### **CAUTION**

- By default field setting value option, this function will not be turned off automatically.
- If you want a Forced mode for a certain amount of duration time, change the field setting value of remote controller.

# Remote Controller Operation

## Adjusting desired temperature

On each screen, press the  or  button to adjust the temperature.

### NOTE

- You can adjust the desired temperature by 0.1, 0.5, 1 °C. (Default 0.5°C)

## Setting the set temperature

On each screen, press the  or  button to select a desired menu and then press the the **OK** button. You can adjust the set temperature by pressing the  or  button.

### NOTE

- When the Reference temperature to control is Water Outlet, you can set the temperature only for Water Outlet.
- When the Reference temperature to control is Indoor, you set the temperatures for Indoor and Water Outlet.
- In case of the model that can support both, you can set only the temperature for Indoor but the temperature for Water Outlet is also affected together.
- Depending on the Reference temperature set for cooling and heating, the controllable temperatures are restricted for each mode.

	Auto	Cool & Heat
Water Outlet	Water Law	Water Outlet
Indoor Temp	-	Indoor Temp



# Power Smart Features

---

There is a variety of useful functionality provided by the Samsung product.

## Operation status

---

Use this to display the operation status:

COMP operation, Back up heater, Booster heater, Solar, Back up boiler, Water pump, Water tank, Defrost operation, Freezing control, DHW Sterilization, Thermostat Installation, Air to air operation, Solar PV, Smart grid, Eco Level.

## Quiet mode

---

Noise from operation can be reduced with the Quiet mode.

### NOTE

- When setting the Quiet mode through a contact from the outdoor unit or setting the Quiet Mode Automatic Time in the service mode using the wired remote controller, the mode cannot be controlled by user entry.

## Outing mode

---

Heating can operate at low temperature while you are out with the Outing mode.





### NOTE

- To cancel this mode, press any button on the remote controller.
- When the Outing mode is On, the Home screen appears before entering the Setting.
- When you press any key, the Outing mode is canceled. However, pressing the keys for switching between the Home and Main screen does not cancel this mode.
  - HOME: Directional button, **OK** button
  - Main Screen: Back button

# Energy-Saving Operation

The product provides functions that allow you to reduce electricity consumption.

## Setting schedule





Press the  button, press the ,  or ,  button to select **Schedule**, and then press the **OK** button. When you select Add a schedule, you can configure settings for Daily schedule, Weekly schedule, Yearly Schedule, and Holiday.

Type	Description
Daily schedule	<ul style="list-style-type: none"><li>• Can set the Quiet mode or hot water status in the preset time.</li><li>• Can set up to 8 schedules.</li></ul>
Weekly schedule	<ul style="list-style-type: none"><li>• Can set the operation for the desired units in the scheduled day and time.<ul style="list-style-type: none"><li>– The scheduling is possible on the weekly basis. You can set the values for day, time, operation On/Off, scheduled units, operation state (operation mode, desired temperature).</li></ul></li></ul>
Yearly Schedule	<ul style="list-style-type: none"><li>• Can create a group for the month to schedule and assign scheduling to the group on the weekly basis.<ul style="list-style-type: none"><li>– Yearly scheduling is possible and the scheduling can be assigned to up to 8 groups.</li></ul></li></ul>
Holiday	<ul style="list-style-type: none"><li>• Can set not to run the weekly and yearly schedules on holidays.</li></ul>

### NOTE

- Weekly and Yearly Schedule can cover settings up to 49.





## Energy

Press the  button, press the ,  or ,  button to select **Energy**, and then press the **OK** button. You can see and set any of Energy Usage and Energy Setting.

Classification	Type	Description
Energy Usage	-	Displays the Instantaneous Power, Weekly Energy Usage, Monthly Energy Usage, Yearly Energy Usage, Energy Usage over Last Year, and Operation Time in graph format.   <b>NOTE</b> <ul style="list-style-type: none"> <li>For accuracy of operation time, use the DMS time.</li> <li>The weekly display follows the ISO 8601 standards.</li> </ul>
Energy Setting	Target Energy Consumption	Sets the target energy consumption.
	Target Operation Time	Sets the target operation time.
	Alarm Popup	Sets whether or not to generate an alarm when the target energy consumption is reached.
	Usage Data Initialization	Initialises the entire energy function.

# Energy-Saving Operation

## TDM (Time-Division Multi) Variables (TDM product Only)

Press the  button, press the ,  or ,  button to select **Priority A2A**, and then press the **OK** button. Setting FSV #5033 to '0' becomes 'Priority A2A', and setting to '1' becomes 'Priority DHW'.

- Under the installation of both A2A (Air-To-Air type air conditioner) and A2W (Air-To-Water type hydro unit) at the same time, our outdoor machine can supply its full capacity to the operating indoor machines (including A2A or A2W). If there are simultaneous operating demands from many A2A machines with A2W, the priority of controlling the outdoor machine (ex: compressor frequency) will be given to A2A, because of their fast response for use's comfort. Only the remaining capacity of outdoor machine will be given to A2W during A2A's normal operation. In this case, it might take very long time for A2W heating, so the outdoor machine will alternate the controlling priorities between A2A and A2W with time basis.
- Priority maximum operation time (at FSV #5033=0): FSV #5031 (Default 30 min., Range 10 ~ 90 min.), After elapsing A2A maximum time, the outdoor machine will operate only for A2W to speed up the A2W's heating/cooling performance, even though there are A2A's continuous operation demands.
- Non priority minimum operation time (at FSV #5033=0): FSV #5032(Default 5 min., Range 3 ~ 60 min.), in this minimum time, the outdoor machine will operate only for A2W, even though there are no more A2W's continuous operation demands.

**<Operating specifications of Time Division Switching (TDS) in accordance with FSV #5033 setting  
(In case of the A2A & A2W simultaneous operation is ON)>**

FSV setting	A2A Cooling + A2W Cooling	A2A Cooling + A2W Heating	A2A Heating + A2W Cooling	A2A Heating + A2W Heating
A2A Priority (#5033=0)	A2A Cooling A2W Cooling Same cooling Mode TDS Control	A2A Cooling A2W Cycle Off (The heater just operates without heating.) Cooling Operation	A2A Heating A2W x (Not operation) Heating Operation	A2A Heating A2W Heating Same heating Mode TDS Control
DHW Priority (#5033=1)	Same with A2A Priority setting	A2W Heating A2A Cooling (Heating + Cooling) TDS Control	Same with A2A Priority setting	Same with A2A Priority setting

※ A2A : Air to Air, A2W : Air to Water





- When DHW Priority is enabled, hot water (heating) operation is given priority only if the A2A & A2W simultaneous operation is on. Other operations are the same as when A2A Priority is enabled.

### CAUTION

- While A2W is in operation, A2A does not operate. This is a normal operation.
- While A2A or A2W is not in simultaneous operation, you can use any mode without operation mode restriction.

# Setting Options

## How to set the Options

- 1 Press the  button.
- 2 Press the   or  button to select Option, and then press the **OK** button.
- 3 See the following pages to select the desired menu.

Step 1	Step 2	Step 3	Step 4	Step 5	Description	Default		
Button Lock					ON/OFF	OFF		
Error List					-	-		
Indoor Unit Information					-	-		
User Mode	Language				Differs depending on the language	First value for the language pack		
	Daylight Saving Time	Daylight Saving Time			ON/OFF	OFF		
		Unit			Day/Week	Week		
		Month			January to December	Mar		
		Week			1st to 4th, F (final week)	F (final week)		
		Day			1 to 31	22		
	Lock	Lock of partial function	All Lock			ON/OFF	OFF	
			Operation Mode Lock	Operation Lock			ON/OFF	OFF
				All Mode Lock			ON/OFF	OFF
				Auto Mode Lock			ON/OFF	OFF
				Cool Mode Lock			ON/OFF	OFF
				Heat Mode Lock			ON/OFF	OFF
			Temperature Lock			ON/OFF	OFF	
	Schedule Lock			ON/OFF	OFF			

# Setting Options

Step 1	Step 2	Step 3	Step 4	Step 5	Description	Default	
User Mode	Wired remote controller	LED			ON/OFF	ON	
		Button Mute			ON/OFF	OFF	
		Current Time	Date	Date Format	YYYY/MM/DD, DD/MM/YYYY, MM/DD/YYYY	DD/MM/YYYY	
				Year/Month/Day	2000 to 2099/1 to 12/1 to 31	2019.01.01	
		Time	Time	Time Format	12-Hour/24-hour	12-Hour	
				Hour/Minute/AM/PM	0 to 12/0 to 60/AM.PM	PM 12 Hour 00 Minute	
		Reset Remote Controller			-	-	
		Display Setting	Screen Saver	Brightness	10 to 100%	100%	
				Timer	10 to 60 seconds	30sec	
				Brightness	0, 10, 30, 50, 70%	30%	
	Smart Reset				-	-	
	Reset All User modes				-	-	
	Service Time Check	Service Call Number				Service call number entered for Service mode	-
		Last Inspection				Final control date entered for Service mode	-



















**NOTE**

- When two wired remote controllers are connected, the brightness can be set within 10 to 50%.

---

## Current Time Setting (Example)

---

- 1 Press the  button.
- 2 Press the   or  button to select **Option**, and then press the **OK** button.
- 3 Press the   or  button to select **User mode**, and then press the **OK** button.
- 4 Press the   or  button to select **Wired remote controller**, and then press the **OK** button.
- 5 Press the   or  button to select **Current time**, and then press the **OK** button.
- 6 Press the   or  button to select **Time**, and then press the **OK** button.
- 7 Press the   or  button to select Time format, Hour, Minute, and AM/PM, and then press the **OK** button.

# Installation/Service mode

---

## Additional functions of the Wired Remote Controller

---

- 1 If you want to use the various additional functions for your Wired Remote Controller, press the  $\wedge$  and  $\vee$  buttons at the same time for more than 3 seconds.
  - The password entry screen appears.
- 2 Enter the password, 0202, and then press the **OK** button.
  - The settings screen for installation/service mode appears.
- 3 See the list of additional functions for the Wired Remote Controller on the next page, and then select the desired menu.
  - Once you have entered the setting screen, the current setting appears.
  - Refer to the chart for data setting.
  - Using the  $\wedge/\vee$  buttons, change the settings and press the  $\rangle$  button to move to the next setting.
  - Press the **OK** button to save the new setting.
  - Press the  $\hookrightarrow$  button to move to the Home screen.



### NOTE

- While setting the data, you can press the  $\hookrightarrow$  button to move to the Home screen after checking the saving status at a pop-up screen.



## Installation/Service mode

### NOTE

- Unavailable functions are marked inactive and they cannot be set.
- If communication initialization is needed after the setting, the system will reset automatically and communication will be initialized.

Step 1	Step 2	Step 3	Description	Default
Service Timer	Service Call Number		16-digit phone number Input: Blank, -, 0-9	-
	Last Inspection		Year, Month, Day	-
	Installation Data		Year, Month, Day	-
Quiet Mode Automatic Time			Enable/Disable	Disable
			Entry time to Exit time	PM 10:00 ~ AM 06:00
Indoor Zone Option	Cool/Heat Selection		Cool & Heat/Heat only	Cool & Heat
	Master/Slave Wired Remote		Master/Slave	Master
	Zone Selection		Zone 1/Zone 2	Zone 1
	Standard Temperature		Water Outlet/Indoor	Water Outlet
	Temperature Unit		Celsius(°C): 1°C/0.5°C/0.1°C	0.5°C
	Temperature Sensor Selection		Wired Remote Controller/External Temperature Sensor	Wired Remote Controller
	Room Temperature Calibration	Reference Temperature		-9 to 40°C
Calibration Value			-9 to 40°C	0°C

# Installation/Service mode

Step1	Step 2	Step 3	Description	Default	
Indoor Zone Option	Indoor Zone Status Information	Central :	ON/OFF	-	
		Normal Power :	ON/OFF	-	
		Mode :	Heat/Cool/Auto	-	
		DHW Power :	ON/OFF	-	
		DHW Mode :	Economic/Standard/Power/Forced	-	
		Water Pump :	ON/OFF	-	
		BUH :	ON/OFF	-	
		BSH :	ON/OFF	-	
		Flow sensor :	lpm	-	
		Inverter Pump :	0% ~ 100%	-	
		EEV Step :	0~2000Step	-	
		Thermostat 1 :	ON/OFF	-	
		Thermostat 2 :	ON/OFF	-	
		DHW Thermostat :	ON/OFF	-	
Connection Information	Number of Connection		0 to 16	-	
	View Master Indoor Unit		Address	-	
	Master Indoor Zone Information	Serial No. :		-	-
		Indoor Unit Eva In Temp.(Teva_in) :		Temperature	-
		Indoor Unit Eva Out Temp.(Teva_out) :		Temperature	-
		Indoor Unit PHE IN(Tw1) :		Temperature	-
		Indoor Unit PHE OUT(Tw2) :		Temperature	-
		DHW Tank Temp. (Tt) :		Temperature	-
		DHW Mode :		Economic/Standard/Power/Forced	-

Installation/Service mode

Step 1	Step 2	Step 3	Description	Default
Device Information	Micom Code :		Micom code	-
	Program Version :		Modified date	-
	Touch Code :		Touch IC code	-
	Program Version :		Modified date	-
	Graphic Image :		Graphic image code	-
	Program Version :		Modified date	-
Reset All Service Modes	Erase All Service mode data		-	-
	Initialize a remote controller		-	-
Power Master Reset <sup>1)</sup> *			-	-
ODU K3 Reset			-	-
Field Setting Value	10**		-	-
	20**		-	-
	30**		-	-
	40**		-	-
	50**		-	-
	Simple Setting		-	-
	FSV Upload/Download		-	-

# Installation/Service mode

Step 1	Step 2	Step 3	Description	Default
Self-Test Mode	Self-Test Mode Display	Water Inlet Temp. :	Temperature	-
		Water Outlet Temp. :	Temperature	-
		Backup Heater Outlet Temp. :	Temperature	-
		Mixing Valve Outlet Temp. :	Temperature	-
		Tank Temp. :	Temperature	-
		Indoor Ambient Temp. :	Temperature	-
		Indoor Ambient Temp.(Zone 2) :	Temperature	-
		Water Outlet Temp. (Zone 1) :	Temperature	-
		Water Outlet Temp. (Zone 2) :	Temperature	-
		Thermostat #1(Zone 1) :	Heat/Cool	-
		Thermostat #2(Zone 2) :	Heat/Cool	-
		Solar Panel	ON/OFF	-
	Water Pump		ON/OFF	OFF
	Booster Heater		ON/OFF	OFF
	DHW Valve(3Way Valve)		ON/OFF	OFF
	Zone 1 Valve		ON/OFF	OFF
	Backup Heater 1 + Water Pump		ON/OFF	OFF
	Backup Heater 2 + Water Pump		ON/OFF	OFF
	Backup Boiler		ON/OFF	OFF
	Zone 2 Valve		ON/OFF	OFF
Mixing Valve		ON/OFF	OFF	

Installation/Service mode

Step 1	Step 2	Step 3	Description	Default
Indoor Unit Option	Address	Main address	00 to 4F	-
		RMC address	00 to FE	-
	Product Option <sup>2)*</sup>		Refer to the installation manual of the connected indoor unit.	-
	Installation Option 1 <sup>2)*</sup>			-
	Installation Option 2 <sup>2)*</sup>			-
	MCU Port	MCU address	00 to 15	-
		MCU Port	A to F	-

1)\* Power Master Reset is a setting needed to supply optimized power to wired remote controller when multiple indoor units are connected to wired remote controller in a group.

2)\* The total option codes are 24 digits. You can set six digits at a time and it is distinguished by page number. Press the **OK** button to move to the next page.

# Installation/Service mode

 **NOTE**

- Address is displayed in hexadecimal. Please refer to the following table.

Hexadecimal	Decimal
00	0
01	1
02	2
03	3
04	4
05	5
06	6
07	7
08	8
09	9
0A	10
0B	11
0C	12
0D	13
0E	14
0F	15

Hexadecimal	Decimal
10	16
11	17
12	18
13	19
14	20
15	21
16	22
17	23
18	24
19	25
1A	26
1B	27
1C	28
1D	29
1E	30
1F	31

Hexadecimal	Decimal
20	32
21	33
22	34
23	35
24	36
25	37
26	38
27	39
28	40
29	41
2A	42
2B	43
2C	44
2D	45
2E	46
2F	47



Hexadecimal	Decimal
30	48
31	49
32	50
33	51
34	52
35	53
36	54
37	55
38	56
39	57
3A	58
3B	59
3C	60
3D	61
3E	62
3F	63

Hexadecimal	Decimal
40	64
41	65
42	66
43	67
44	68
45	69
46	70
47	71
48	72
49	73
4A	74
4B	75
4C	76
4D	77
4E	78
4F	79

---

## How to upload or download field settings (example)

---

- 1 Insert an SD card into the Sub PBA SD Card slot on the Hydro unit.
- 2 Select Field Setting Value in the Service mode.
- 3 Press the  or  button to select FSV Upload/Download.



### NOTE

- Upload: Uploads the FSV data of the Hydro unit to the SD card.
- Download: Downloads the FSV data of the SD card to the Hydro unit.
- The upper-level controllers excluding Wi-Fi kit (2.0) and MWR-WW10\*\* wired remote controller cannot use the 2-zone control and energy monitoring.
- When connecting between the MWR-WW10\*\* wired remote controller and an upper-level controller, the settings for FSV (4061) must be changed not to use the 2-zone control.

# Field setting mode

## NOTE

- Be sure to reset the power when changing the FSV (#3041 to 3046) of disinfection operation and the FSV (#5011 to 5019) of setting the outing mode.

## Field Setting Value (FSV) 10\*\*

Code 10\*\* : Upper and lower temperature limits of each operation mode of wired remote controller  
Heating(Water Out, Room), Cooling(Water Out, Room), DHW(Tank)

Main Menu & Code	Menu	Function				Sub Code	MODEL CODE : AE200(260) RNW***			MODEL CODE : MIM-E03CN		
							Setting Standard			Setting Standard		
		Item	Step	Unit	Default		Min.	Max.	Default	Min.	Max.	
Remote Controller Setting Range Code 10**	Cooling	Water Out Temperature for Cooling	Max	1	°C	1011	25	18	25	25	18	25
			Min	1	°C	1012	16	5	18	16	5	18
		Room Temperature for Cooling	Max	1	°C	1021	30	28	30	30	28	30
			Min	1	°C	1022	18	18	28	18	18	28
	Heating	Water Out Temperature for Heating	Max	1	°C	1031	65	37	65	65	37	65
			Min	1	°C	1032	25	15	37	25	15	37
		Room Temperature for Heating	Max	1	°C	1041	30	18	30	30	18	30
			Min	1	°C	1042	16	16	18	16	16	18
	DHW	DHW tank Temperature	Max	1	°C	1051	55	50	70	55	50	70
			Min	1	°C	1052	40	30	40	40	30	40

## NOTE

- The FSV #3011 in the wired remote controller should be set to 1 or 2 to use the DHW mode.



---

## Remote Controller Setting Range: Code 10\*\*

---

### Space Cooling

- Target water outlet temperature : Upper limit(#1011, Default 25°C, Range : 18 ~ 25°C),  
Lower limit(#1012, Default 16°C, Range : 5 ~ 18°C)
  - With this default FSV settings, user can change the target water outlet temperature within the range of 5 ~ 25°C for cooling.
- Target room temperature : Upper limit(#1021, Default 30°C), Lower limit(#1022, Default 18°C)
  - With this default FSV settings, user can change the target room temperature within the range of 18 ~ 30°C for cooling.

### Space Heating

- Target water outlet temperature : Upper limit(#1031, Default 65°C, Range : 37 ~ 65°C),  
Lower limit(#1032, Default 25°C, Range : 15 ~ 37°C)
  - With this default FSV settings, user can change the target water outlet temperature within the range of 25 ~ 65°C for heating.
- Target room temperature : Upper limit(#1041, Default 30°C), Lower limit(#1042, Default: 16°C)
  - With this default FSV settings, user can change the target room temperature within the range of 16 ~ 30°C for heating.

### DHW Heating

- Target DHW tank temperature : Upper limit(#1051, Default 55°C, Range : 50 ~ 70°C),  
Lower limit(#1052, Default 40°C, Range : 30 ~ 40°C)
  - With this default FSV settings, user can change the target tank temperature within the range of 40 ~ 55°C for DHW heating.

# Field setting mode

## Field Setting Value (FSV) 20\*\*

Code 20\*\* : Water law design and external room thermostat Heating(2 WL's for floor & FCU),  
Cooling(2 WL's for floor & FCU), WL & Thermostat types

Main Menu & Code	Menu	Function				Sub Code	MODEL CODE : AE200(260)RNW***			MODEL CODE : MIM-E03CN		
							Setting Standard			Setting Standard		
		Item		Step	Unit		Default	Min.	Max.	Default	Min.	Max.
Water Law Code 20**	Heating	Outdoor Temperature for Heating Water Law	Max (Point ①)	1	°C	2011	-10	-20	5	-10	-20	5
			Min (Point ②)	1	°C	2012	15	10	20	15	10	20
		Water out Temperature for WL1 Heating (UFHs)	Max (Point ①)	1	°C	2021	40	17	65	40	17	65
			Min (Point ②)	1	°C	2022	25	17	65	25	17	65
		Water out Temperature for WL2 Heating (FCUs)	Max (Point ①)	1	°C	2031	50	17	65	50	17	65
			Min (Point ②)	1	°C	2032	35	17	65	35	17	65
	Heating Water Law Selection	WL Type	-	-	2041	1(WL1)	1	2	1(WL1)	1	2	
	Cooling	Outdoor Temperature for Cooling Water Law	Max (Point ①)	1	°C	2051	30	25	35	30	25	35
			Min (Point ②)	1	°C	2052	40	35	45	40	35	45
		Water out Temperature for WL1 Cooling (UFHs)	Max (Point ①)	1	°C	2061	25	5	25	25	5	25
			Min (Point ②)	1	°C	2062	18	5	25	18	5	25
		Water out Temperature for WL2 Cooling (FCUs)	Max (Point ①)	1	°C	2071	18	5	25	18	5	25
			Min (Point ②)	1	°C	2072	5	5	25	5	5	25
	Cooling Water Law Selection	WL Type	-	-	2081	1(WL1)	1	2	1(WL1)	1	2	
	External Control	External Room Thermister	#1 (UFHs)	1	-	2091	0(No)	0	4	0(No)	0	4
			#2 (FCUs)	1	-	2092	0(No)	0	4	0(No)	0	4
	Remote Controller	Remote Controller Room Temp. Control		1	-	2093	4	1	4	4	1	4

## Water Law & Room Thermostat/ Wired remoted controller: Code 20\*\*

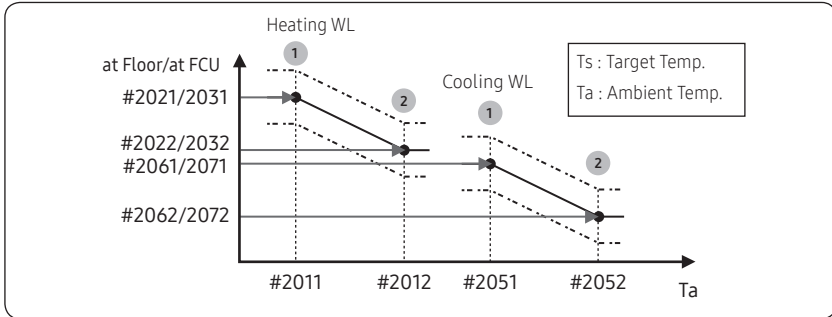

### Water Law for Heating

- Outdoor air temperature range : Lower limit ① (#2011, Default -10°C, Range : -20 ~ 5°C), Upper limit ② (#2012, Default 15°C, Range : 10 ~ 20°C)
  - With this default settings, the water outlet temperature by heating water law can be changed within the outdoor temperature range of -10 ~ 15°C.
- Water out temperature range for floor/FCU applications respectively : Upper limit ① (#2021/2031, Default 40/50°C, Range : 17 ~ 65°C), Lower limit ② (#2022/2032, Default 25/35°C, Range : 17 ~ 65°C)
  - With this default settings, the water outlet temperature by heating water law can be changed within the range of 25/35 ~ 40/50°C.
- Type of water law for according to heating devices(floor/FCU) : #2041(Default 1(WL1 for floor)), 2(WL2 for FCU or radiator)

### Water Law for Cooling

- Outdoor air temperature range : Lower limit ① (#2051, Default 30°C, Range : 25 ~ 35°C), Upper limit ② (#2052, Default 40°C, Range : 35 ~ 45°C)
  - With this default settings, the water outlet temperature by cooling water law can be changed within the outdoor temperature range of 30 ~ 40°C.
- Water out temperature range for floor/FCU applications respectively : Upper limit ① (#2061/2071, Default 25/18°C), Lower limit ② (#2062/2072, Default 18/5°C)
  - With this default settings, the water outlet temperature by cooling water law can be changed within the range of 5/18 ~ 18/25°C.
- Type of water law for according to cooling devices(floor/FCU) : #2081(Default 1(WL1 for floor)), 2(WL2 for FCU or radiator)

# Field setting mode

## External Room Thermostat (Field Option)

- Terminal #1 (#2091, Default 0 for no usage), #2 (#2092, Default 0 for no usage)
  - To use wired remote controller for heating/cooling operation, both of the above settings should be set to 0 simultaneously. If not, thermostat controls system.
  - If set to #2091/#2092 1, the compressor can be turned on or off only by the thermostat.
  - If set to #2091/#2092 2~4, the compressor can be turned on or off by the thermostat or according to the WL discharged water temperature. (#2092 2, WL Thermo off → Water pump off, #2092 3, WL Thermo off → Water pump on, #2092 4, WL Thermo off → Water pump 7min off → 3min on →.....).

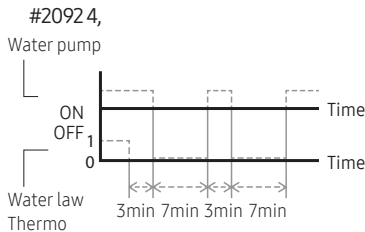
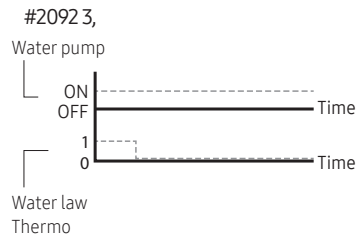
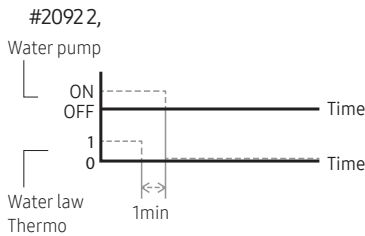

- Types of water law used by room thermostat operation will follow the FSV settings defined in #2041 (heating) and #2081 (cooling) respectively.
- During the thermostat operation, the user has the possibility to shift up or down the target water temperature within the range of -5 ~ +5°C.

- 
- When the remote controller is used, floor valve should be connected to zone #1 and the FCU valve should be separately connected to zone #2 of the Hydro Unit PBA.
  - When only floor cooling/heating is installed and if the Water Law or outlet water temperature is too low, 2way valve may closed and E911 error may occur.
  - When the floor and FCU units are installed together and operating in cooling mode, floor valve may close and E911 may occur to prevent floor condensation when the outlet water temperature is below 16°C. Therefore FCU should secure minimum value for the flow rate.
  - Thermostat #2 which controls FCU has the priority for operation modes and the discharge water temperature.
  - Samsung is not responsible for the accidents such as floor condensations which can occur by not connecting the valve to the zone #1 port of the Hydro Unit PBA.

#### **Remote controller room temperature control**

- Control by room temperature sensor (Service mode)
  - If set to #2093 1, the compressor can be turned on or off only by Room temp sensor.
  - If set to #2093 2~4, the compressor can be turned on or off by Room Temp. sensor or according to the WL discharged water temperature.  
(#2093 2, WL Thermo off → Water pump off, #2093 3, WL Thermo off → Water pump on, #2093 4, WL Thermo off → Water pump 7min off → 3min on →.....).

# Field setting mode

## Field Setting Value (FSV) 30\*\*

Code 30\*\* : User's options for Domestic Hot Water(DHW) tank heating

Main Menu & Code	Menu	Function				Sub Code	MODEL CODE : AE200(260)RNW***			MODEL CODE : MIM-E03CN		
							Setting Standard			Setting Standard		
		Item	Step	Unit	Default		Min.	Max.	Default	Min.	Max.	
Domestic Hot Water Tank Code 30**	DHW	DHW mode activate	DHW mode	-	-	3011	1	0	2	0	0	2
		Heat Pump	Max. Temp.	1	°C	3021	55	45	55	55	45	55
			Stop	1	°C	3022	0	0	10	2	0	10
			Start	1	°C	3023	5	5	30	5	5	30
			Min. Operating Time	1	min	3024	5	1	20	5	1	20
			Max. Operating Time	5	min	3025	30	5	95	30	5	95
			Operation Interval	0.5	hour	3026	3	0.5	10	3	0.5	10
		Booster Heater	On/Off	-	-	3031	1(On)	0(Off)	1	1(On)	0(Off)	1
			Delay Time	5	min	3032	20	20	95	20	20	95
			Overshoot	1	°C	3033	0	0	4	0	0	4
		Disinfection	On/Off	-	-	3041	1(On)	0(Off)	1	1(On)	0(Off)	1
			Interval	1	day	3042	Fri(5)	Sun(0)	All(7)	Fri(5)	Sun(0)	All(7)
			Start Time	1	o'clock	3043	23	0	23	23	0	23
			Target Temp.	5	°C	3044	70	40	70	70	40	70
			Duration	5	min	3045	10	5	60	10	5	60
			Max time	1	hour	3046	8	1	24	8	1	24
		Forced DHW Operation	Timer OFF Function	-	-	3051	0(No)	0	1(Yes)	0(No)	0	1(Yes)
			Time Duration	1	(x10) min	3052	6	3	30	6	3	30
		Solar Panel/ DHW Thermostat	H/P Combination	1	-	3061	0(No)	0	2	0(No)	0	2
		3-way Valve	Defalut Direction	-	-	3071	0(Room)	0	1(Tank)	0(Room)	0	1(Tank)

Main Menu & Code	Menu	Function				Sub Code	MODEL CODE : AE200(260)RNW***			MODEL CODE : MIM-E03CN		
		Item		Step	Unit		Setting Standard			Setting Standard		
							Default	Min.	Max.	Default	Min.	Max.
Domestic Hot Water Tank Code 30**	Addition Function	Energy metering	Backup Heater 1step capacity	1	kW	3081	2	1	6	2	1	6
			Backup Heater 2step capacity	1	kW	3082	2	0	6	2	0	6
			Booster Heater capacity	1	kW	3083	3	1	6	3	1	6

## DHW Heating : Code 30\*\*

### DHW Application

The FSV #3011 in the wired remote controller should be set to 1 or 2 to use DHW function.

If FSV #3011 is set to 1, the DHW operation starts based on the thermo on temperature.

If FSV #3011 is set to 2, the DHW operation starts based on the thermo off temperature.

(For example, when the current temperature becomes 45°C under the conditions that the thermo on temperature is 43°C and the thermo off temperature is 48°C, the DHW turns off if FSV #3011 is set to 1 and DHW turns on if FSV #3011 is set to 2.)

### Heat Pump Variables for Controlling DHW Tank

- Maximum DHW tank temperature with R-410A(refrigerant) heat pump operation : FSV #3021, Default 55°C, Range : 45 ~ 55°C.
- Temperature difference determining the heat pump OFF temperature : FSV #3022, Range : 0 ~ 10°C.
- Temperature difference determining the heat pump ON temperature : FSV #3023, Default 5°C, Range : 5 ~ 30°C.

# Field setting mode

## [DHW Tank water temperature thermo on/off control]

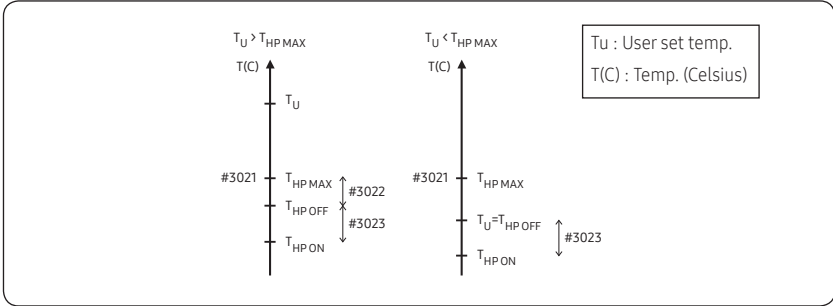

- DHW heating mode timer : Mode timer manage the operation terms when there are simultaneous requests of space heating/cooling and DHW.
  - FSV #3024 (minimum Space heating operating time, Default 5 min., Range 1 ~ 20 min.), #3025 (maximum DHW time, Default 30 min., Range 5 ~ 95 min.), #3026(maximum space heating operation time, Default 3 hour, Range 0.5 ~ 10 hour)
  - Maximum operation time is applied only when both DHW and Space heating request operation. DHW or Space heating operates continuously until reaching at target temperature without time limitation in the single operation.

## [Time variation control of DHW and space heating mode]

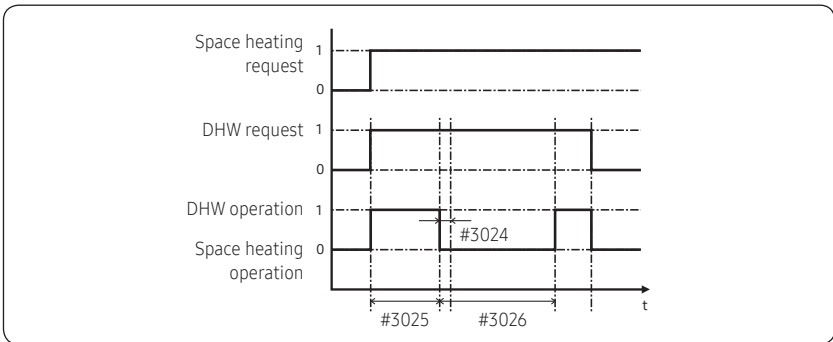



## [Time variation control of Heat pump and booster heater of DHW]

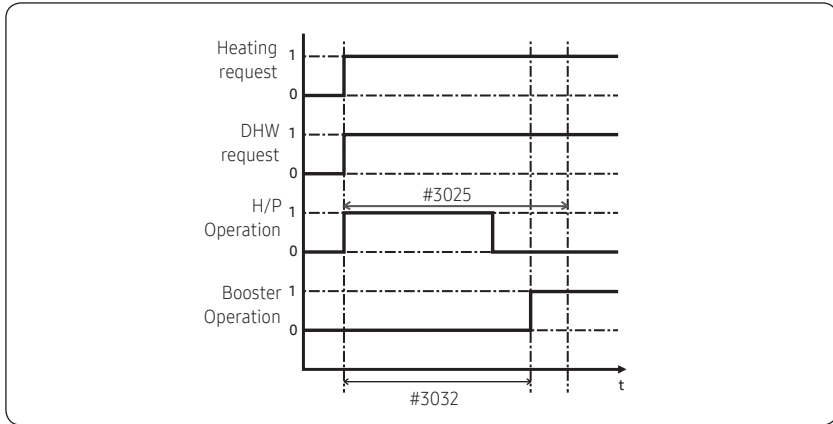

### NOTE

- The FSV #4022 for booster heater priority should be set to “0 (both)” or “2” (booster) to use booster heater.
- If not(backup heater priority), the booster heater can be operated in case of no backup heater demand.

### Booster Heater Variables for Controlling DHW Tank

- The FSV #3031 should be set to “1(On)” (Default) to use booster heater as an additional heat source for DHW tank.
- Booster heater startup delay timer : In case of DHW request, this timer will delay the operation of booster heater compared to heat pump.
  - FSV #3032 (Default 20 min., Range 20 ~ 95 min.), In “Power/Forced” DHW mode, the delay timer will be neglected, and the booster starts immediately.
  - In “Economic” DHW mode, the DHW heating will be conducted only with heat pump.
  - #3032 should be smaller than the maximum H/P time (#3025). If the delay time is set too high, it might take very long time for DHW heating.
- Temperature difference determining the booster heater OFF temperature ( $T_{BH\ OFF} = T_u + \#3033$ ) : FSV #3033, Default 0°C, Range : 0 ~ 4°C.
- Temperature difference determining the booster heater ON temperature ( $T_{BH\ ON} = T_{BH\ OFF} - 2$ )

# Field setting mode

## <Example of using BSH in hot water supply>

Case 1) When set temperature is 70°C

BSH is ON at less than 68 degrees, OFF at more than 70°C.

Case 2) When setting temperature is 50°C (FSV 3022 = 0 condition)

Heat pump and BHS are ON at less than 45 degrees, OFF at more than 50°C

(Thermo off / on operation temperature is used together)

## [Thermo on/off control of Heat pump and Booster Heater]

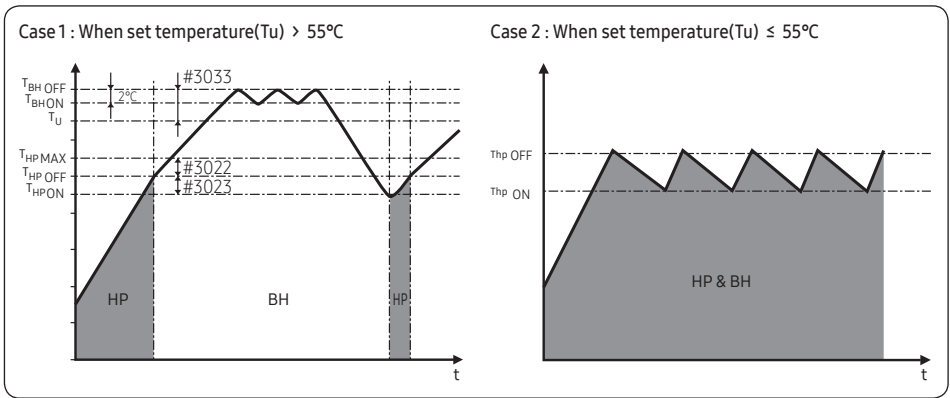

## Disinfection Function

- The FSV #3041 should be set to "1 (On)" (Default) to use disinfection function.
  - Scheduling : Day (#3042, Default "Friday"), starting time (#3043, Default "23:00"), target tank temp. (#3044, Default "70°C"), duration (#3045, Default 10 min.)

## [Time variation control of Heat pump and booster heater of DHW]

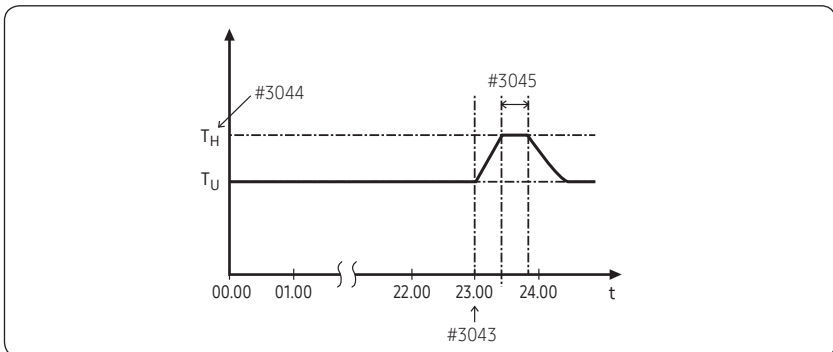

---

 **NOTE**

- Disinfection function is available only when a booster heater is connected.
- Check tank capacity, booster heater capacity, and booster heater for issues if disinfection operation does not work normally over the maximum operation time(E919 error).

**Forced DHW by User's Input**

- Forced mode can be activated by changing setting value from the setting (#3011, "0" (No)).
- Forced mode shall be working depending on Timer setting (#3051, #3052).

**Additional Solar panel/DHW thermostat Installation for DHW with Heat Pump (Field Option)**

- Solar panel and heat pump are able to operate simultaneously by setting value. (FSV #3061, "1")
- When using DHW thermostat, set the FSV #3061, "2".
- Zone #1 and #2 valve always keep open except DHW mode in "ON" when the power is "ON" unless changing the FSV #3071. Default: Room direction valves are open and DHW valve is closed.
- Zone #1 and #2 can be open separately or simultaneously but all three zone valves can not be open or closed at the same time.
- There is one minute delay of 2-way / 3-Way valve closing whereas no delay of valve opening.
- Individual zone control is only available with external thermostat.
- FSV 3071 determines a 3-way direction.

**Energy metering**

- To accurately indicate energy consumption, the capacity of the backup heater and booster heater must be set using FSV #3081 / 3082 / 3083.

# Field setting mode

## Field Setting Value (FSV) 40\*\*

Code 40\*\* : User's options for heating devices including internal backup heater and external boiler

Main Menu & Code	Menu	Function				Sub Code	MODEL CODE : AE200(260)RNW***			MODEL CODE : MIM-E03CN		
							Setting Standard			Setting Standard		
		Item	Step	Unit	Default		Min.	Max.	Default	Min.	Max.	
Heating Code 40**	Heating	Heat Pump	Heating / DHW priority	-	-	4011	0 (DHW)	0	1 (Heating)	0 (DHW)	0	1 (Heating)
			Low Outdoor Temp. for Heating Priority	1	°C	4012	0	-15	20	0	-15	20
			Heating Off Temp.	1	°C	4013	35	14	35	35	14	35
		Backup Heater	On/Off	-	-	4021	0 (No)	0	2	0 (No)	0	2
			BUH/BSH Priority	1	-	4022	2 (BSH)	0 (Both)	2 (BSH)	0 (Both)	0	2 (BSH)
			Cold weather compensation	-	-	4023	1 (Yes)	0 (No)	1	1 (Yes)	0 (No)	1
			Threshold Temp.	1	°C	4024	0	-25	35	0	-25	35
			Defrost Backup Temp.	5	°C	4025	15	10	55	15	10	55
		Backup Boiler	Back-up Boiler On/Off	-	-	4031	0 (No)	0	1 (Yes)	0 (No)	0	1 (Yes)
			Boiler Priority	-	-	4032	0 (No)	0	1 (Yes)	0 (No)	0	1 (Yes)
			Threshold Condition	1	°C	4033	-15	-20	5	-15	-20	5
		Mixing valve	Application	1	-	4041	0 (No)	0	2	0 (No)	0	2
	Target $\Delta T$ (Heating)		1	°C	4042	10	5	15	10	5	15	
	Target $\Delta T$ (Cooling)		1	°C	4043	10	5	15	10	5	15	
	Control factor		1	-	4044	2	1	5	2	1	5	
	Control interval		1	min	4045	2	1	30	2	1	30	
	Running Time		3	(x10) min	4046	9	6	24	9	6	24	
	Inverter Pump	Application	-	-	4051	1	0	2	1	0	2	
		Target $\Delta T$	1	°C	4052	5	2	8	5	2	8	
		Control factor	1	-	4053	2	1	3	2	1	3	
Addition Function	Zone controll		1	-	4061	0 (No)	0	1 (Yes)	0 (No)	0	1 (Yes)	

## Additional heating option : 40\*\*

### Heat Pump Variables for Space Heating

- FSV #4011 for DHW priority is set to "0(DHW)" (Default) as a default. Space heating gets a priority by setting FSV #4011 "1", but this is only valid when the outdoor temperature is lower than the specified temperature defined by FSV #4012.
- Cold weather compensation is applied when the space heating gets a priority (FSV #4011=1). It is due to position of heating coil and booster heater in the water tank. Heating coil is at the bottom part of the water tank and the booster heater is located at the middle part of the tank. So the heating coil is efficient to heat the whole water in the tank. Chances that hot water flows through the heating coil decrease with the space heating priority. And lower part of water in the tank might not get enough heat with the booster heater.
- Space heating off temperature(FSV #4013, Default "35 °C", Range 14 ~ 35 °C): At high outdoor temperature above this value, the space heating will be turned off, to avoid overheating.

### Backup Heater Variables for Space Heating

- The FSV #4021 should be set to 1(Yes) to use 2-stage electric backup heater in hydro unit as an additional heat source. (If FSV # 4021 is 2, a 1-stage electric backup heater is used)
- To compensate the lowered heat pump heating performance under very cold weather conditions, the FSV #4023 should be set to "1(On)"(Default).
  - The threshold temperature to use backup heater for cold weather compensation: FSV #4024, Default "0 °C", Range -25 ~ 35 °C
  - The backup heater operation is restricted to save energy in the threshold temperature range.
- The FSV #4022 for backup heater priority should be set to "0 (both)" (Default) or "1" (backup) to use backup heater. If not (booster heater priority), the backup heater can be operated in case of no booster heater demand.
- The threshold temperature for backup heater operation during defrost mode to prevent cold draft because of chilled water can be controlled by adjusting FSV #4025. Under FSV #4025 of water outlet temperature, backup heater Will be turned on.

### NOTE

- To use both heaters together at the same time, please check the capacity of the power circuit breaker of your house before use.

### External Backup Boiler for Space Heating (Field Option)

- The FSV #4031 should be set to "1 (Yes)" to use a backup boiler as an additional heat source. (default: "0 (No installation)")
- Priority of backup boiler and heat pump is defined by FSV #4032 (default: "0 (OFF)")
- To compensate the lowered heat pump heating performance under very cold weather conditions, the backup boiler operates instead of heat pump under the threshold temperature (FSV #4033, Default "-15 °C", Range -20 ~ 5 °C).

# Field setting mode

## Mixing valve Installation(Field Option)

- The FSV #4041 should be set to "1 or 2" to use mixing valve.
- ※ 4041 =1 : Controlled based on the temperature difference (4042, 4043)
- ※ 4041 =2 : Controlled based on the temperature difference of the WL value

ex) Heating

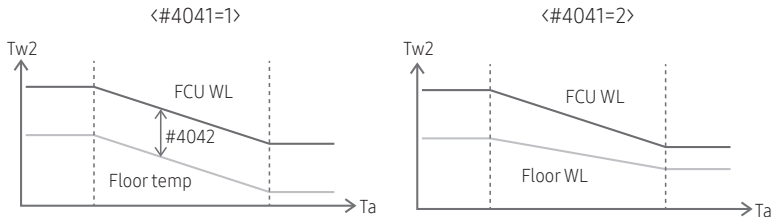

- FSV #4042 / #4043 is for adjusting temperature difference between  $Tw3$ ( $Tw2$ ) and  $Tw4$ .
- When using mixing valve, FSV #4046 should be matched with mixing valve running time characteristic.

## Inverter Pump Installation(Field Option)

- FSV #4051=1(Default) : Inverter pump use + Output 100%, FSV #4051=2 : Inverter pump use + Output 70%, FSV #4051=0 : Inverter pump Not use.
- FSV #4052 is for adjusting temperature difference between  $Tw2$  and  $Tw1$ .

### NOTE

- $Tw1$  (Inlet Water Temp),  $Tw2$  (Discharge Water Temp),  $Tw3$  (Backup Heater outlet Water Temp),  $Tw4$  (Mixing valve Temp.)
- Zone Control Using Wired Remote Control(Install option)  
FSV #4061 should be set to "1(Yes)" to zone control.

## Field Setting Value (FSV) 50\*\*

Code 50\*\* : User's options for extra functions

Main Menu & Code	Menu	Function			Sub Code	MODEL CODE : AE200 (260)RNW***			MODEL CODE : MIM-E03CN		
						Setting Standard			Setting Standard		
		Item	Step	Unit		Default	Min.	Max.	Default	Min.	Max.
Others Code 50**	Outing Mode	Water Out Temperature for Cooling	1	°C	5011	25	5	25	25	5	25
		Room Temperature for Cooling	1	°C	5012	30	18	30	30	18	30
		Water Out Temperature for Heating	1	°C	5013	15	15	55	15	15	55
		Room Temperature for Heating	1	°C	5014	16	16	30	16	16	30
		Cooling WL1 Temp.	1	°C	5015	25	5	25	25	5	25
		Cooling WL2 Temp.	1	°C	5016	25	5	25	25	5	25
		Heating WL1 Temp.	1	°C	5017	15	15	55	15	15	55
		Heating WL2 Temp.	1	°C	5018	15	15	55	15	15	55
	DHW Saving	DHW tank Temp.	1	°C	5019	30	30	70	30	30	70
		DHW Saving Temp	1	°C	5021	5	0	40	5	0	40
		DHW Saving Mode	1	-	5022	0	0	1	0	0	1
	Power Peak Control	DHW Saving Thermo on Temp.	1	°C	5023	25	0	40	25	0	40
		Application	-	-	5041	0 (No)	0	1 (Yes)	0 (No)	0	1 (Yes)
		Select forced off parts	1	-	5042	0 (All)	0	3	0 (All)	0	3
		Using input voltage	-	-	5043	1 (High)	0 (Low)	1	1 (High)	0 (Low)	1
		Frequency Ratio Control	-	-	5051	0 (No)	0	1 (Yes)	0 (No)	0	1 (Yes)

# Field setting mode

Main Menu & Code	Menu	Function				Sub Code	MODEL CODE : AE200 (260)RNW***			MODEL CODE : MIM-E03CN		
							Setting Standard			Setting Standard		
		Item	Step	Unit	Default		Min.	Max.	Default	Min.	Max.	
Others Code 50**	Additional Function	PV Control	Application	1	-	5081	0 (No)	0	1 (Yes)	0 (No)	0	1 (Yes)
			Setting Temp Shift Value (Cooling)	1	°C	5082	2	1	20	2	1	20
			Setting Temp Shift Value (Heating)	1	°C	5083	2	1	50	2	1	50
		Smart Grid Control	Application	1	-	5091	0 (No)	0	1 (Yes)	0 (No)	0	1 (Yes)
	Setting Temp Shift Value (Heating)		1	°C	5092	2	1	50	2	1	50	
	Setting Temp Shift Value (DHW)		1	°C	5093	5	1	40	5	1	40	
	DHW Mode ((Target Tank Temp.))		1	-	5094	0	0	1	0	0	1	

## Others : Code 50\*\*

### Outing Mode

- All the target temperatures – space heating and cooling, water law, DHW, Room temperature – are set to the values defined in the above table under the holiday mode.

### NOTE

- With the lowered target temperatures (FSV #5011 ~ #5019), the system operates normally.

### Economic DHW Heating

- DHW heating only by the heat pump to save energy (Operated in Eco mode of wired remote control)  
Target DHW temperature is lower than the temperature set by user.  
The temperature difference is defined by FSV #5021. (default: 5°C) If user sets the temperature 45°C, the system sets the target temperature 40°C with the default setting.
  - If user want additional energy saving, use a "Saving mode" (#5022, default : 0, OFF)
  - The user can set the "Thermo On" temperature during "Saving mode" using FSV #5023



---

## Peak Power Control

- If users make contracts with local electric power company for limiting the amount of power consumption when a surge in power usage, users can set FSV of "Forced off".
- According to FSV (#5041), Default is Non-usage. And According to FSV (#5042), If input is "0 (default)", Back up heater (BUH) is unavailable while external contact is high.  
If input is "1", Only Compressor(Heat Pump) is available.  
If input is "2", Only Booster Heater (BSH) is available.  
If input is "3", nothing is available.

[D-00]	Compressor	Back up heater	Booster heater
0 (Default)	Permitted	Forced off	Permitted
1	Permitted	Forced off	Forced off
2	Forced off	Forced off	Permitted
3	Forced off	Forced off	Forced off

- Applying the control when power voltage of input contact is high is default. According to FSV (#5043), it is available to adopt this logic in low condition exceptionally.
- When applying to this logic, SAMSUNG controller come to get "Thermo off" condition for all operation.
- If not used for a long time, anti-freeze fluid shall be used for preventing damage to the unit in cold condition.

## FR Control(Frequency ratio control) - Display "DR" on wired remote control

- This is to limit the maximum frequency of the outdoor unit compressor. (if #5051 = 1 "use")
  - Method 1 : External DC signal Control uses a DC voltage of 0 ~ 10V (0v = 50%, ~ 10v = 150%)
  - Method 2 : Demand ratio (DR) control through Modbus communication.

# Field setting mode

---

## PV Control (Photovoltaics control)

---

This is for energy saving by using the solar energy.

The FSV #5081 should be set to "1(Yes)" for PV control.

FSV	0	1
#5081	Disable (Default)	Activation

### NOTE

- Except for how water mode, This function is activated only for the outing mode.
- **Cooling mode (FSV #5082 = 2°C, Default)**
  - Room sensor setting: Current setting value - FSV #5082 (Min = FSV #1022)
  - Water outlet setting: Current setting value - FSV #5082 (Min = FSV #1012)
  - Water law setting: Current setting value - FSV #5082 (Min = FSV #2061, #2062, #2071, #2072)
- **Heating mode (FSV #5083 = 2°C, Default)**
  - Room sensor setting: Current setting value + FSV #5083 (Max = FSV #1041)
  - Water outlet setting: Current setting value + FSV #5083 (Max = FSV #1031)
  - Water law setting: Current setting value + FSV #5083 (Max = FSV #2021, #2022, #2031, #2032)
- **Hot water mode**
  - Thermo on operation regardless of outing mode: Setting temperature = Max temperature of hot water mode (FSV #1051)

---

## Smart Grid Control

---

The FSV #5091 should be set to "1(Yes)" for Smart Grid control.

FSV	0	1
#5091	Disable (Default)	Activation

### Operation mode for Smart Grid

Operation Mode	Terminal 1	Terminal 2
Mode 1	Short	Open
Mode 2	Open	Open
Mode 3	Open	Short
Mode 4	Short	Short

- Mode 1 : Forced thermo off operation of all system
- Mode 2 : Normal operation  
It is equally applied both heating and hot water mode.
- Mode 3 : Normal operation (FSV #5092 = 2°C, FSV #5093 = 5°C, Default)  
The heating and hot water setting temperature are set by the FSV setting value.
  - Heating mode (Room sensor setting) : Current setting value + FSV #5092
  - Heating mode (Water outlet setting) : Current setting value + FSV #5092
  - Heating mode (Water law setting) : Current setting value + FSV #5092
  - Hot water mode : Current setting value + FSV #5093
- Mode 4 : Forced operation on → (TBD, Under review)  
Even though it is not the "Thermo On" condition, it will be the "Thermo On" as heating or hot water mode.

#### Hot water mode

- #5094=0 : Standard hot water operation (Only heat pump is operated) :  
Target setting temperature is 55°C.
- #5094=1 : Power/Forced hot water operation (Heat pump + Booster heater are operated.) :  
Target setting temperature is 70°C.

#### Heating mode

- Heating mode (Room sensor setting) : Current setting value + FSV #5092+3°C (Max=FSV #1041)
- Heating mode (Water outlet setting) : Current setting value + FSV #5092+5°C (Max=FSV #1031)
- Heating mode (Water law setting) : Current setting value + FSV #5092+5°C  
(Max=FSV #2021, #2022, #2031, #2032)

# Maintaining the Unit

---

## Maintenance activities

---

- In order to ensure optimal availability of the unit, a number of checks and inspections on the unit and the field wiring have to be carried out at regular intervals, preferably yearly.  
This maintenance should be carried out by SAMSUNG local technician. Besides keeping the remote controller clean by means of a soft damp cloth, no maintenance is required by the operator.

### **WARNING**

- During longer periods of standstill, e.g. during summer with a heating only application, it is very important NOT TO SWITCH OFF THE POWER SUPPLY towards the unit.
- Switching off the power supply stops the automatic repetitive movement of the motor in order to prevent it from getting jammed.

## Emergency heating / Emergency hot water supply

---

### <Emergency heating\_(when using #4021)>

- Heating function is performed only by the backup heater if the outdoor unit malfunctions (available only when a backup heater is connected).
- Enabling the function : Turn off the Control kit Dip S/W #1, and then turn the power off and on.
- Disabling the function : Turn on the Control kit Dip S/W #1, and then turn the power off and on.
- Default operation : Automatic heating is performed at a set temperature of 35°C.

### <Emergency hot water supply\_(when using FSV #3011, 3031)>

- Hot water is supplied only by the booster heater if the outdoor unit malfunctions.
- Enabling the function : Turn off the Control kit Dip S/W #2, and then turn the power off and on.
- Disabling the function : Turn on the Control kit Dip S/W #2, and then turn the power off and on.
- Default operation : Automatic hot water supply is performed at a set temperature of 50°C.

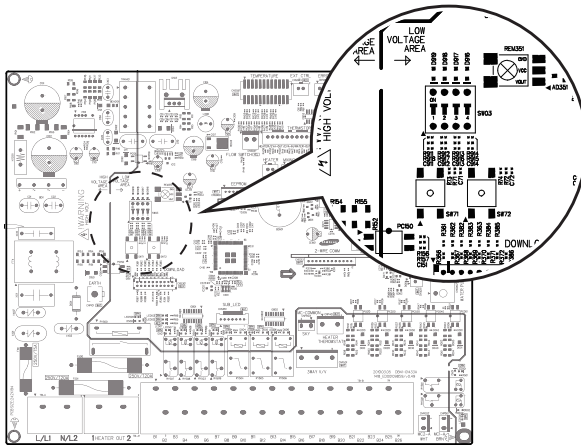

# Troubleshooting tips

If the unit has some problem to work properly, error codes will be displayed on the wired remote controller. The following table describes the explanation of the error codes.

Display	Explanation
120	Short- or open-circuit error of the room temperature sensor of the Zone 2 indoor unit (detected only when the room thermostat is used)
121	Short- or open-circuit error of the room temperature sensor of the Zone 1 indoor unit (detected only when the room thermostat is used)
653	Wired remote controller thermistor SHORT or OPEN
899	Zone1 Water Outlet Themistor SHORT or OPEN
900	Zone2 Water Outlet Themistor SHORT or OPEN
901	Water Inlet thermistor SHORT or OPEN
902	PHE Outlet thermistor SHORT or OPEN
903	Water Outlet thermistor SHORT or OPEN
904	Water TANK thermistor SHORT or OPEN
9 16	Mixing Valve thermistor SHORT or OPEN

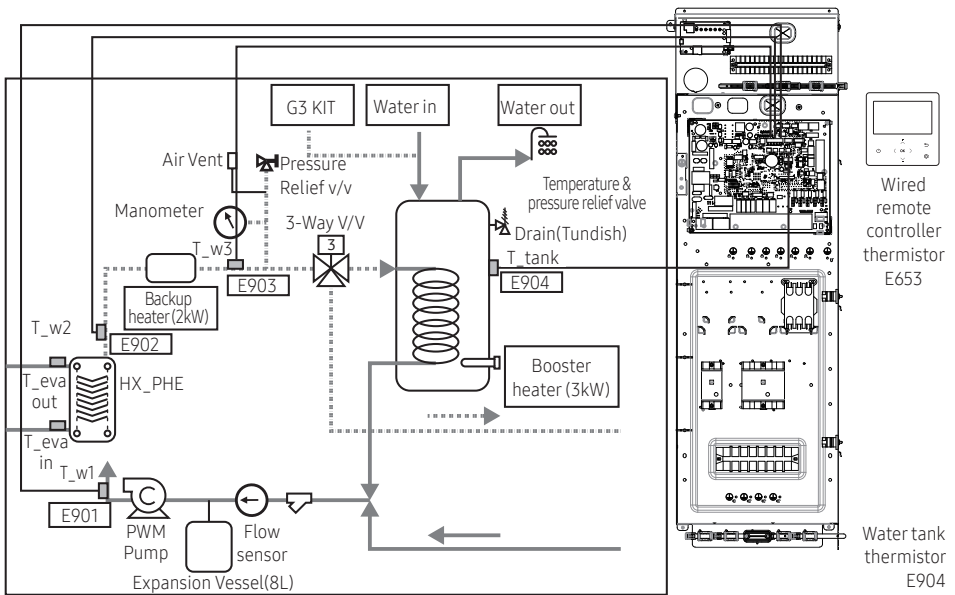

## Communication

Display	Explanation
601	Communication error between remote controller and the Hydro unit
604	Tracking error between remote controller and the Hydro unit
654	Memory(EEPROM) Read/Write Error(Wired remote controller data error)

### E601, E604

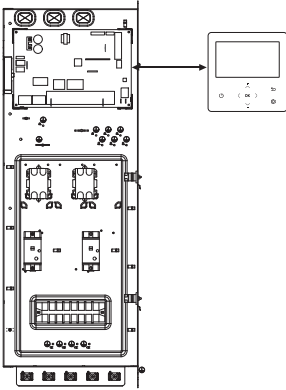

### E654

- MEMORY(EEPROM) Read/Write Error (Wired controller data error)

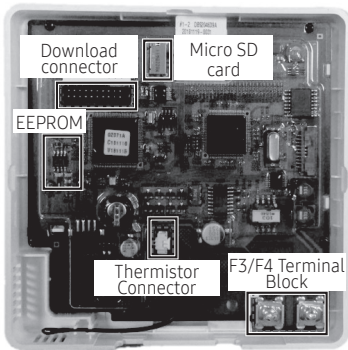

# Troubleshooting tips

## Water pump & Flow Sensor

Display	Explanation
911	Low flow rate error <ul style="list-style-type: none"> <li>in case of low flow rate in 30 sec during water pump signals is ON(Starting)</li> <li>in case of low flow rate in 15 sec during water pump signals is ON(After starting)</li> </ul>
912	Normal flow rate error <ul style="list-style-type: none"> <li>in case of normal flow rate in 10min during water pump signal is OFF</li> </ul>

### E911

- Water pump ON ( Low flow rate ) : NOT enough water flow

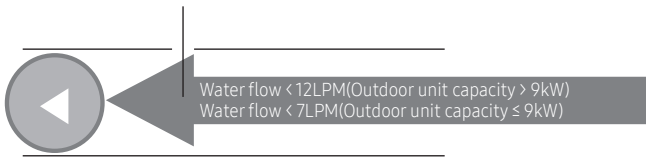

### E912

- Water pump OFF ( Normal flow rate )

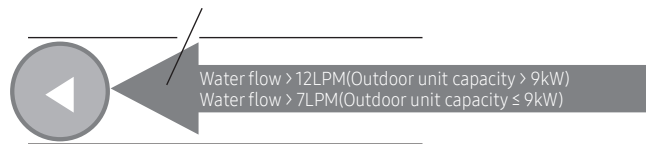



# Error codes

Display	Explanation	ErrorSource
101	Hydro Unit / Outdoor Unit communication connection error	Hydro Unit
120	Short- or open-circuit error of the room temperature sensor of the Zone 2 indoor unit (detected only when the room thermostat is used)	Hydro Unit
121	Short- or open-circuit error of the room temperature sensor of the Zone 1 indoor unit (detected only when the room thermostat is used)	Hydro Unit
122	EVA Inlet temp sensor SHORT or OPEN	Hydro Unit
123	EVA Outlet temp sensor SHORT or OPEN	Hydro Unit
162	EEPROM Error	Hydro Unit
198	Error of Terminal Block's Thermal Fuse(Open)	Hydro Unit
201	Hydro Unit / Outdoor Unit communication error(Matching error)	Hydro Unit/Outdoor Unit
202	Hydro Unit / Outdoor Unit communication error(3 min)	Hydro Unit/Outdoor Unit
203	Communication error between INVERTER and MAIN MICOM (4 min)	Outdoor Unit
221	Outdoor Unit air temperature sensor error	Outdoor Unit
231	Condenser temperature sensor error	Outdoor Unit
251	Discharge temperature sensor error	Outdoor Unit
320	OLP sensor error	Outdoor Unit
403	Detection of freezing (During cooling operation)	Outdoor Unit
404	Protection of Outdoor Unit when it is overload (during Safety Start, Normal operation state)	Outdoor Unit
407	Comp down due to high pressure	Outdoor Unit
416	Discharge of a compressor is overheated	Outdoor Unit
419	OUTDOOR UNIT EEV operation error	Outdoor Unit
425	Power source line missing error (only for 3-phase model)	Outdoor Unit
440	Heating operation blocked (outdoor temperature over 35 °C)	Outdoor Unit
441	Cooling operation blocked (outdoor temperature under 9 °C)	Outdoor Unit
458	OUTDOOR UNIT fan1 error	Outdoor Unit
461	[Inverter] Compressor startup error	Outdoor Unit
462	[Inverter] Total current error/PFC over current error	Outdoor Unit
463	OLP is overheated	Outdoor Unit

# Error codes

Display	Explanation	Error Source
464	[Inverter] IPM over current error	Outdoor Unit
465	Compressor overload error	Outdoor Unit
466	DC LINK over/low voltage error	Outdoor Unit
467	[Inverter] Compressor rotation error	Outdoor Unit
468	[Inverter] Current sensor error	Outdoor Unit
469	[Inverter] DC LINK voltage sensor error	Outdoor Unit
470	Outdoor unit EEPROM Read/Write Error	Outdoor Unit
471	Outdoor unit EEPROM Read/Write Error(OTP error)	Outdoor Unit
474	IPM(IGBT Module) or PFCM temperature sensor Error	Outdoor Unit
475	Outdoor Unit Fan2 error	Outdoor Unit
484	PFC Overload Error	Outdoor Unit
485	Input current sensor error	Outdoor Unit
500	IPM is overheated	Outdoor Unit
554	Gas leak error	Outdoor Unit
590	Inverter EEPROM Checksum error	Outdoor Unit
601	Communication error between the Hydro Unit and wired remote controller	Hydro Unit
604	Communication tracking error between the Hydro Unit and wired remote controller	Hydro Unit
653	Wired remote controller temp sensor SHORT or OPEN	Hydro Unit, Wired Remote Controller
654	Memory(EEPROM) Read/Write Error(Wired remote Controller data error)	Hydro Unit, Wired Remote Controller
899	Short- or open-circuit error of the Zone 1 water-out temperature sensor	Hydro Unit
900	Short- or open-circuit error of the Zone 2 water-out temperature sensor	Hydro Unit
901	Water inlet (PHE) temperature sensor error(open/short)	Hydro Unit
902	Water outlet (PHE) temperature sensor error(open/short)	Hydro Unit
903	Water outlet (backup heater) temperature sensor error	Hydro Unit
904	DHW tank temperature sensor error	Hydro Unit
906	Refrigerant gas inlet (PHE) temperature sensor (open/short)	Outdoor Unit

Display	Explanation	ErrorSource
911	Low flow rate error <ul style="list-style-type: none"> <li>in case of low flow rate in 30 sec during water pump signals is ON(Starting)</li> <li>in case of low flow rate in 15 sec during water pump signals is ON(After starting)</li> </ul>	Hydro Unit
912	Normal flow rate error <ul style="list-style-type: none"> <li>in case of normal flow rate in 10min during water pump signal is OFF</li> </ul>	Hydro Unit
916	Mixing valve sensor error	Hydro Unit
919	Error that the set temperature for disinfection operation is not reached, or, after reaching, the temperature fails to continue for the requested time	Hydro Unit

## QUESTIONS OR COMMENTS?

COUNTRY	CALL	OR VISIT US ONLINE AT
UK	0330 SAMSUNG (7267864)	<a href="http://www.samsung.com/uk/support">www.samsung.com/uk/support</a>
IRELAND (EIRE)	0818 717100	<a href="http://www.samsung.com/ie/support">www.samsung.com/ie/support</a>
GERMANY	06196 77 555 77 *OTH	<a href="http://www.samsung.com/de/support">www.samsung.com/de/support</a>
FRANCE	01 48 63 00 00	<a href="http://www.samsung.com/fr/support">www.samsung.com/fr/support</a>
ITALIA	800-SAMSUNG (800.7267864)	<a href="http://www.samsung.com/it/support">www.samsung.com/it/support</a>
SPAIN	91 175 00 15	<a href="http://www.samsung.com/es/support">www.samsung.com/es/support</a>
PORTUGAL	808 207 267	<a href="http://www.samsung.com/pt/support">www.samsung.com/pt/support</a>
LUXEMBURG	261 03 710	<a href="http://www.samsung.com/be_fr/support">www.samsung.com/be_fr/support</a>
NETHERLANDS	088 90 90 100	<a href="http://www.samsung.com/nl/support">www.samsung.com/nl/support</a>
BELGIUM	02-201-24-18	<a href="http://www.samsung.com/be/support">www.samsung.com/be/support</a> (Dutch) <a href="http://www.samsung.com/be_fr/support">www.samsung.com/be_fr/support</a> (French)
NORWAY	21629099	<a href="http://www.samsung.com/no/support">www.samsung.com/no/support</a>
DENMARK	707 019 70	<a href="http://www.samsung.com/dk/support">www.samsung.com/dk/support</a>
FINLAND	030-6227 515	<a href="http://www.samsung.com/fi/support">www.samsung.com/fi/support</a>
SWEDEN	0771 726 786	<a href="http://www.samsung.com/se/support">www.samsung.com/se/support</a>
POLAND	801-172-678* lub +48 22 607-93-33* Specjalistyczna infolinia do obsługi zapytań dotyczących telefonów komórkowych: 801-672-678* * (opłata według taryfy operatora)	<a href="http://www.samsung.com/pl/support/">http://www.samsung.com/pl/support/</a>
HUNGARY	0680SAMSUNG (0680-726-7864)	<a href="http://www.samsung.com/hu/support">www.samsung.com/hu/support</a>
AUSTRIA	0800 72 67 864 (0800-SAMSUNG)	<a href="http://www.samsung.com/at/support">www.samsung.com/at/support</a>

COUNTRY	CALL	OR VISIT US ONLINE AT
SWITZERLAND	0800 726 78 64 (0800-SAMSUNG)	<a href="http://www.samsung.com/ch/support">www.samsung.com/ch/support</a> (German) <a href="http://www.samsung.com/ch_fr/support">www.samsung.com/ch_fr/support</a> (French)
CZECH	800 - SAMSUNG (800-726786)	<a href="http://www.samsung.com/cz/support">www.samsung.com/cz/support</a>
SLOVAKIA	0800 - SAMSUNG (0800-726 786)	<a href="http://www.samsung.com/sk/support">www.samsung.com/sk/support</a>
CROATIA	072 726 786	<a href="http://www.samsung.com/hr/support">www.samsung.com/hr/support</a>
BOSNIA	055 233 999	<a href="http://www.samsung.com/support">www.samsung.com/support</a>
MONTENEGRO	020 405 888	<a href="http://www.samsung.com/support">www.samsung.com/support</a>
SLOVENIA	080 697 267 (brezplačna številka)	<a href="http://www.samsung.com/si/support">www.samsung.com/si/support</a>
SERBIA	011 321 6899	<a href="http://www.samsung.com/rs/support">www.samsung.com/rs/support</a>
ALBANIA	045 620 202	<a href="http://www.samsung.com/al/support">www.samsung.com/al/support</a>
BULGARIA	*3000 Цена в мрежата 0800 111 31 , Безплатна телефонна линия	<a href="http://www.samsung.com/bg/support">www.samsung.com/bg/support</a>
ROMANIA	*8000 (apel in retea) 08008-726-78-64 (08008-SAMSUNG) Apel GRATUIT Atenție: Dacă efectuați apelul din rețeaua Digi (RCS/RDS), vă rugăm să ne contactați formând numărul Telverde fără ultimele două cifre, astfel: 0800872678.	<a href="http://www.samsung.com/ro/support">www.samsung.com/ro/support</a>
CYPRUS	8009 4000 only from landline, toll free	
GREECE	80111-SAMSUNG (80111 726 7864) only from land line (+30) 210 6897691 from mobile and land line	<a href="http://www.samsung.com/gr/support">www.samsung.com/gr/support</a>
LITHUANIA	8-800-77777	<a href="http://www.samsung.com/lt/support">www.samsung.com/lt/support</a>
LATVIA	8000-7267	<a href="http://www.samsung.com/lv/support">www.samsung.com/lv/support</a>
ESTONIA	800-7267	<a href="http://www.samsung.com/ee/support">www.samsung.com/ee/support</a>

## SAMSUNG ELECTRONICS CO., LTD.

107, Hanamsandan 6beon-ro, Gwangsan-gu, Gwangju-si, Korea 62218

### Samsung Electronics

Service Department

PO Box 12987, Blackrock, Co. Dublin. Ireland

or

Blackbushe Business Park, Yateley, GU46 6GG. UK



This appliance is filled with R-32.