

# Inverter Packaged Air-Conditioners

## **FD** series

High Performance Air-Conditioning

# 2019



**New FDT**  
4 way



**New FDTC**  
4 way compact

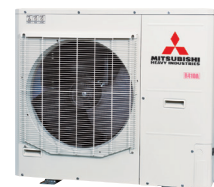







# Inverter Packaged Air-Conditioners

## **FD** High Performance Air-Conditioning *series*

The PAC range from Mitsubishi Heavy Industries Thermal systems is ideal for air conditioning offices, shops, restaurants, and bars ... as well as other commercial environments. The versatility of the PAC range, offers you a wide selection of models in function of your installation needs. The modern and attractive design of our indoor units is harmoniously integrated in the any atmosphere creating a pleasant and relaxing environment.



## Contents

<b>Product Information</b>	<b>4</b>
<b>Product Line Up</b>	<b>14</b>
<b>Outdoor Units</b>	<b>16</b>
<b>Indoor Units</b> <small>Bennefits Summary</small>	<b>22</b>
<b>FDT</b> <small>Ceiling Cassette -4way-</small>	<b>24</b>
<b>FDTC</b> <small>Ceiling Cassette -4way compact-</small>	<b>36</b>
<b>FDU</b> <small>Duct Connected -High Static Pressure-</small>	<b>42</b>
<b>FDUM</b> <small>Duct Connected -Low/Middle Static Pressure-</small>	<b>48</b>
<b>SRK</b> <small>Wall Mounted</small>	<b>58</b>
<b>FDE</b> <small>Ceiling Suspended</small>	<b>62</b>
<b>FD</b> <small>Floor Standing</small>	<b>72</b>
<b>Energy efficient and environmentally conscious</b>	<b>77</b>
<b>Control Systems</b>	<b>80</b>
<b>Outdoor Unit Dimensions</b>	<b>84</b>





# Next Generation Refrigerant R32

New Indoor Unit, Outdoor Unit line up available for R32



## F-GAS REGULATION (EU) No 517/2014

Introduced in January 2015 to regulate the use of Fluorinated Greenhouse Gases (F-Gases)

The Hydrofluorocarbons (HFCs) are F-Gases used in the HVACR sector (Heating, Ventilation, Air-Conditioning and Refrigeration)

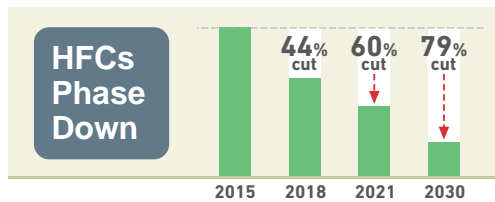

**OBJECTIVE**  
To protect the environment by reducing the F-Gases emissions

**IMPACT ON HFCs(in EU)**  
HFCs Phase Down  
HFCs Ban

### SOLUTIONS

- Use lower GWP\* refrigerants in new equipment
- Use high-efficiency equipment with less refrigerant charge
- Check refrigerant leaks regularly

\* GWP is the Global Warming Potential of a refrigerant, representing how much heat an F-Gas traps in the atmosphere

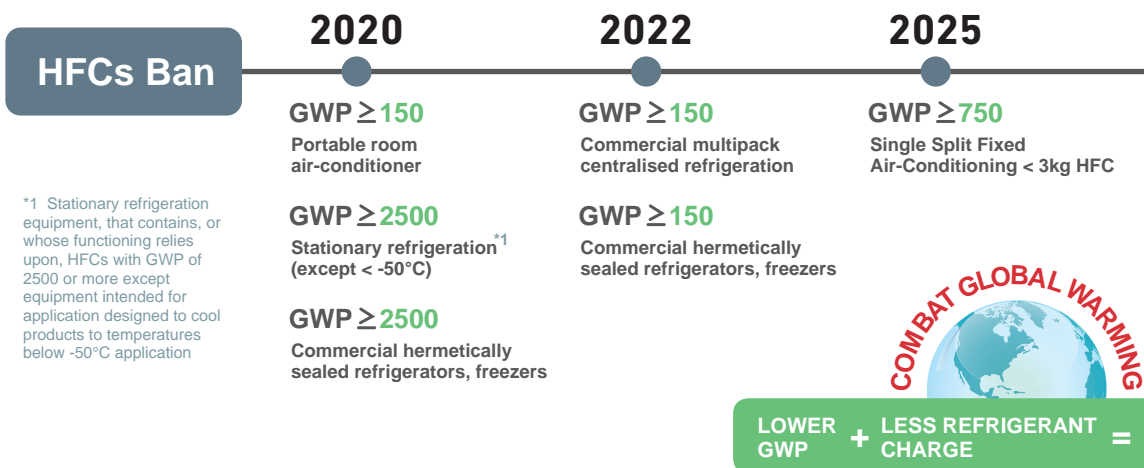

\*1 Stationary refrigeration equipment, that contains, or whose functioning relies upon, HFCs with GWP of 2500 or more except equipment intended for application designed to cool products to temperatures below -50°C application



# R32 - A Low GWP Refrigerant

- A single component, easy to handle refrigerant
- Known as a component of the blend R410A(50% R32, 50% R125)
- Already used in Air-Conditioning systems worldwide
- Zero Ozone Depletion
- Superior Energy Efficiency vs. R410A
- Reduced refrigerant charge vs. R410A
- Easy to recycle

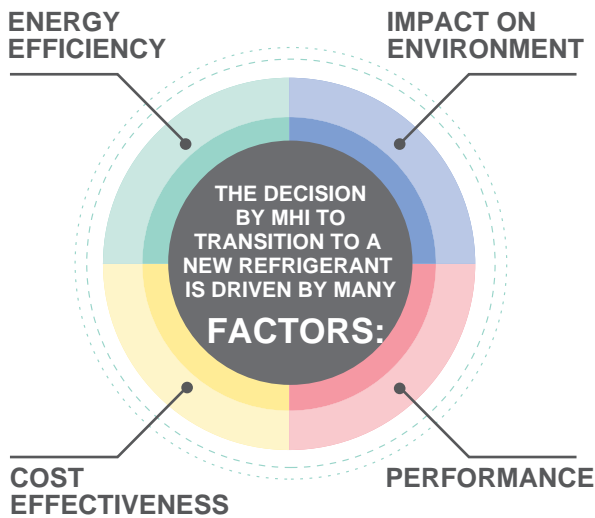
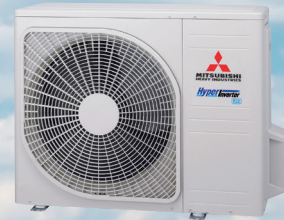

## Low Global Warming Potential

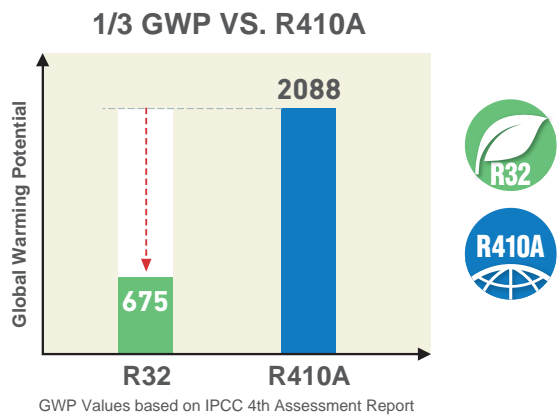

## Superior Energy Efficiency

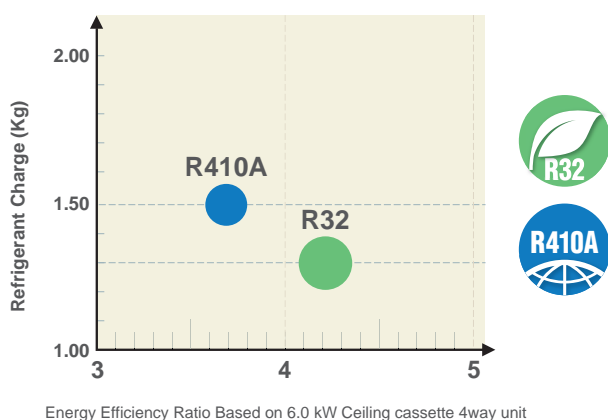

## Reduced Refrigerant Charge

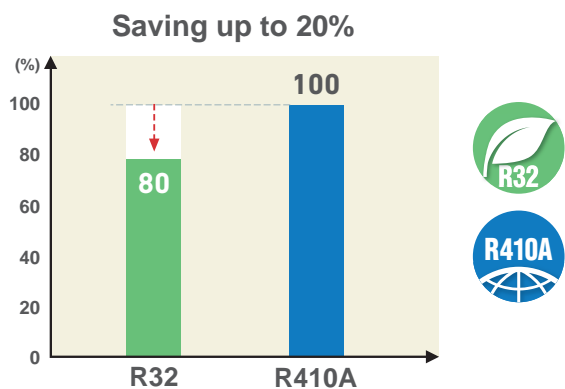



# New Generation

Ceiling Cassette  
4way

New

# FDT



- Automatic energy saving control
- Keep maximum comfort with minimal draft
- Quiet operation

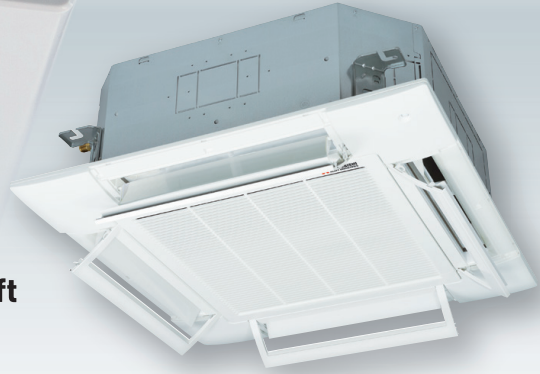

## High energy efficiency with new technology

New FDT can achieve higher seasonal efficiency by Mitsubishi Heavy Industries latest technology.

● SEER and SCOP is defined in European regulations. Please refer to P77.

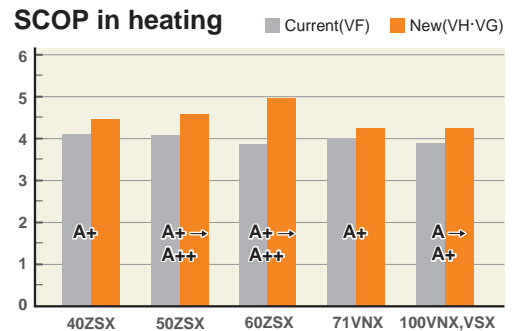
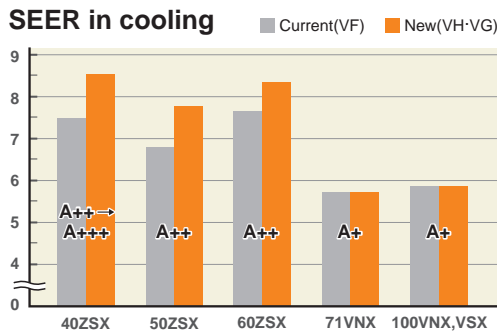

## Quieter noise & Improved aerodynamic performance of the unit

New technology has realised quiet noise with keeping capacity and comfort. A low noise is achieved by reducing the pressure fluctuation in an indoor unit.

A fan guard attains both safety and quietness by flow.

New design turbo fan

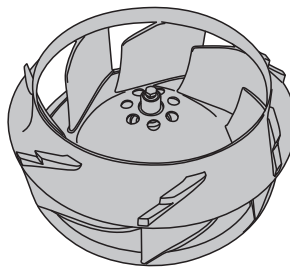

Fan guard (standard equipment)



## Flexible flap control for draft prevention Brand new function in the market



**Draft Prevention Panel (Option)**

4 additional flaps are to be controlled individually at each operation mode. They change air flow direction and prevents draft feeling. This new function also achieve more flexible control for air flow direction.



**Motion Sensor (Option)**

New motion sensor (option) detects human activity. Energy saving control is achieved by shifting set temperature according to detected amount of activity.



Ceiling Cassette  
4way compact

New

# FDTC

R32 R410A  
Hybrid

- More comfort and More energy saving
- New European design
- Lower noise



## European Design & Flat Panel

### Thin Panel

FDTC thin panel fit within 10mm from the ceiling.

### Unique Grille Design

Honeycomb grille

### Big Louver

Improved distribution



### Compact Design

□700mm → □620mm

A weight of only 14kg.  
Height of thin panel and main body is only 248mm allowing it to be a very easy installation.



### Integrated Ceiling System Design(600x600)



## Quieter Operation

(Sound Pressure level in the Lo mode)

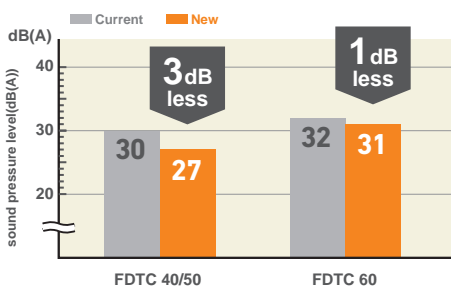

Adopting new turbo fan and improving new heat exchanger enable to reduce noise.

## Draft Prevention Panel and Motion Sensor (option)



It is available to set draft prevention panel and motion sensor as well as FDT.

# Draft Prevention Panel

Keep maximum comfort with minimal draft:  
New FDT & FDTC control flaps with more flexibility.



Ceiling cassette Compact  
**FDTC-VH** series



Ceiling cassette  
**FDT-VH** series



**GOOD  
DESIGN**

The Good Design Award is Japan's only comprehensive design evaluation and recommendation initiative, originating with the "Good Design Products Selection System" founded in 1957. It is now a global design award with participation from numerous Japanese and international companies and organizations. The "G Mark", the symbol of the Good Design Award, is known widely as a symbol of excellent design. (FDT)

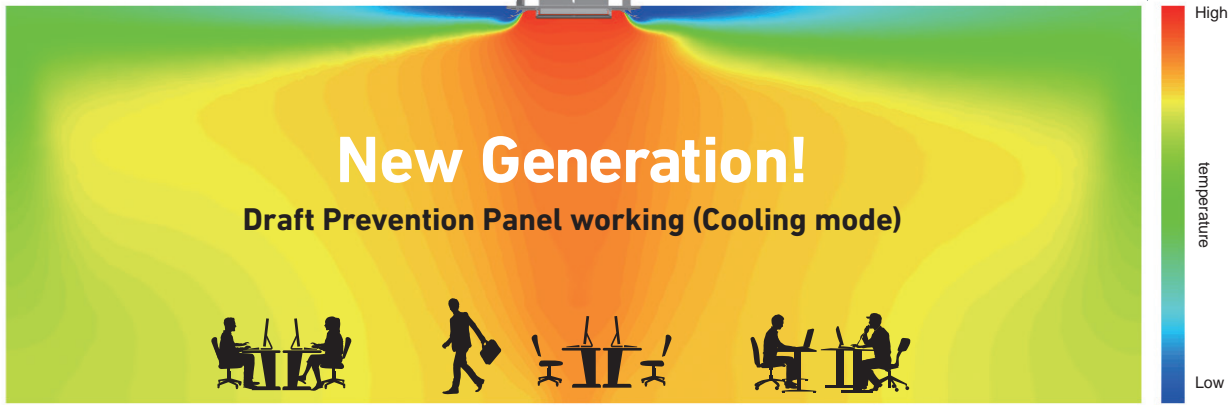
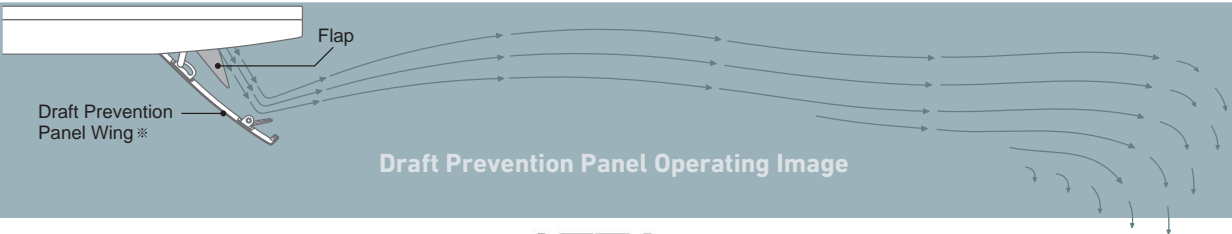

Draft Prevention Panel placed at off position

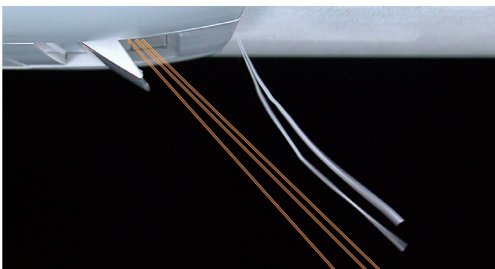

Draft Prevention Panel working ※

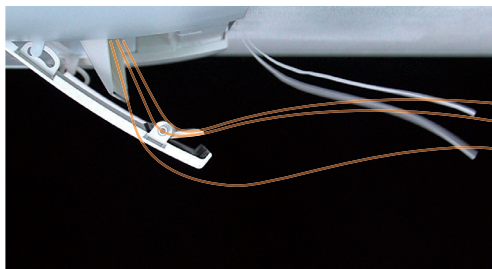

Draft Prevention Panel provides a comfortable airflow without any draft feeling. Whether cooling or heating a room, the remote control can be used to instantly suppress any warm or cool drafts. This accurately assists how air flow is directed out of the indoor unit.

※ These are images of FDT.  
The panel structure of FDTC slightly differ from FDT.

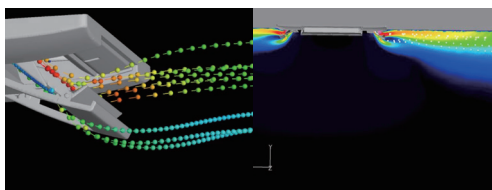
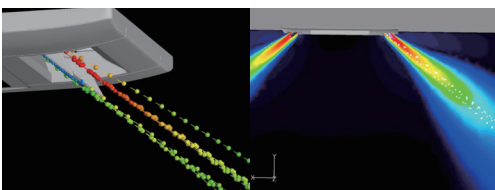



## Energy saving control by detecting human movement

### 3 Step Control

<b>1 Power Control</b>	New motion sensor (option) detects human activity. Energy saving control is achieved by shift set temperature according to detected amount of activity.
<b>2 Stand by</b>	Unit will go on stand-by mode when no activity is detected. When unit will detect activity again, unit will re-start operation automatically.
<b>3 Auto Off</b>	Unit will go off automatically when no activity is detected for 12 hours.

Applied models

FDT /  
FDTC / FDU / FDUM / FDE **New**

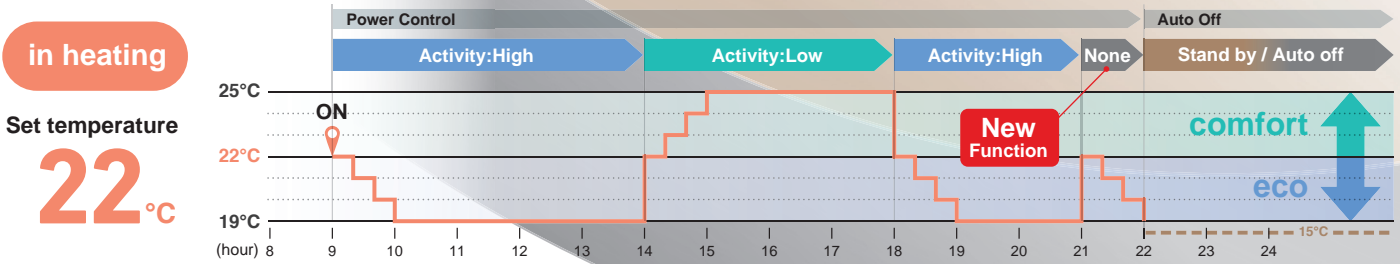
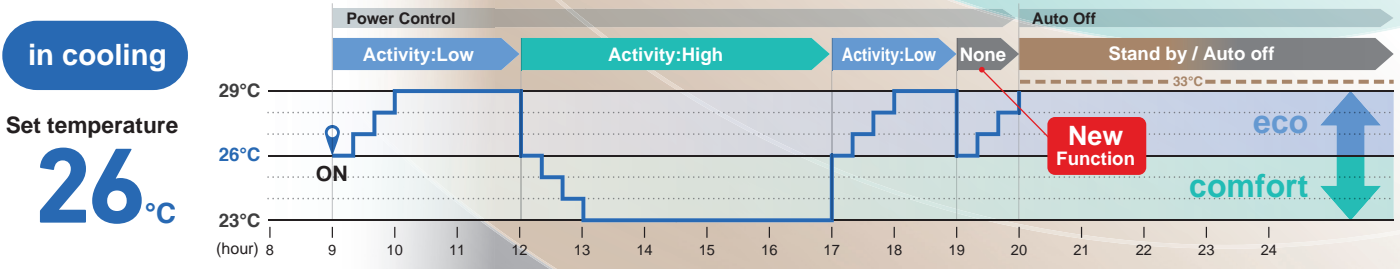
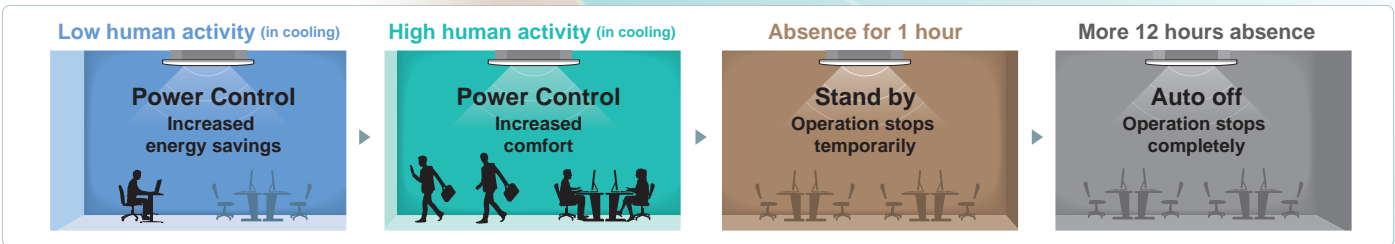

Operation mode and Control of Motion sensor		eco operation		Operation mode				
		comfort operation		Auto	Cool	Heat	Dry	Fan
Power Control ※1	Human activity 	Low		Cooling +3°C Heating +3°C	+3°C	+3°C	—	—
		High		Cooling -3°C Heating -3°C	-3°C	-3°C	—	—
		None		Cooling +3°C Heating -3°C	+3°C	-3°C	—	—
Auto Off ※2				●	●	●	●	●

※1 Set temperature is revised maximum  $\pm 3^{\circ}\text{C}$  at Cooling/Heating mode by detecting heat volume movement.

※2 Absence for 1 hour  $\Rightarrow$  Operation stops ("Stand-by") More 12 hours absence  $\Rightarrow$  Operation stops completely

# Remote Control

Added new function

Simple use with advanced settings  
**REMOTE CONTROL**

Easy touch and Easy view with full dot Liquid Crystal display

# RC-EX3A



## Function Switch

The function switch allows you to select and set two functions that you desire among the seven available functions shown.

These functions can be used by simply pressing the button after they are set, allowing you to use your preferable functions immediately.

### 1. Anti Draft ON/OFF



**New** Anti draft can be turned ON/OFF with a single tap of the button.

### 2. High Power Mode



High Power Mode achieve excessive cooling / heating capacity for 15 minutes to quickly adjust the room temperature to a comfortable level.

### 5. Home Leave Mode



Home leave mode maintains the room temperature at a moderate level.

### 3. Energy Saving Mode



Temperature is set to optimized to save energy without losing comfort.

### 6. Favourite Mode



Operation mode, set temperature, fan speed and air flow direction are automatically adjusted to the programmed favorite setting.

### 4. Quiet Mode



Outdoor unit starts to operate quietly by activating this mode. The time of this mode can be set in conjunction with Indoor Silent Timer.

### 7. Filter Sign



Announces the due time for cleaning the air filter.

## Favourite Mode

Operation mode, set temperature, fan speed and air flow direction are memorized and allocated to two buttons that can be operated by one touch.

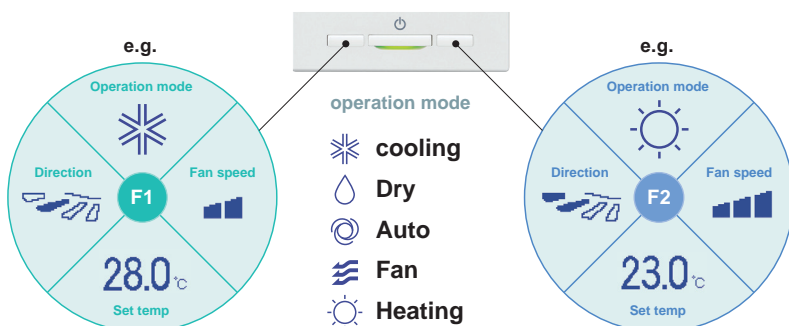

## Adjustable Brightness of the Operation Lamp

The brightness of the operation lamp behind Run/Stop switch can be adjusted by 10 stages.

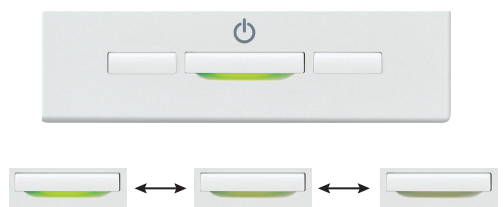



## Draft Prevention Setting New

(only FDT•FDTC series)

User can enable/disable the motion of panel with anti draft for each blow outlet for each operation mode. This function can be set while operating.

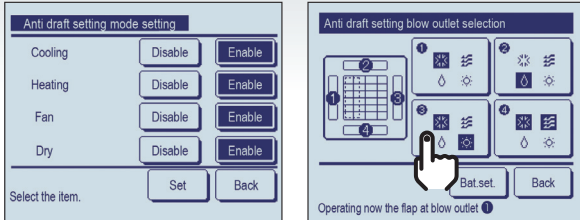

## Easy Modification of Air Flow

User can visually confirm and set the direction of louvres using the visual display on the remote controller.

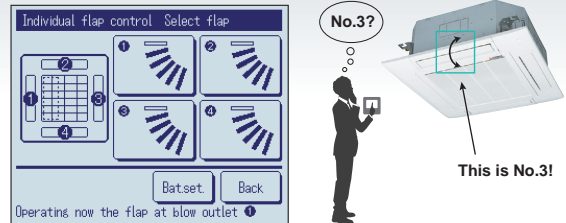

## Motion Sensor Control

Presence of humans and the amount of motion are detected by a motion sensor to perform various controls.

### 1 Select Enable / Disable Motion sensor control



Enable/Disable

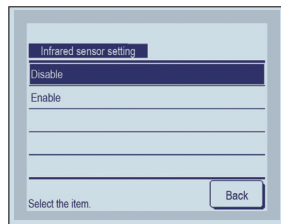

Select **Enable/Disable** for the motion sensor of the indoor unit connected to the R/C.

### 2 Select Enable / Disable per control

- Power control
- Auto-off

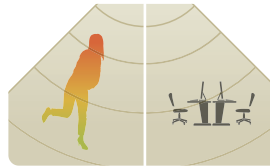

Enable/Disable

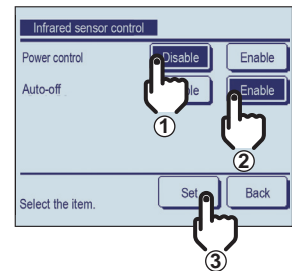

## Backup Control

Control restricted to two indoor units (two groups)



### Fault backup control

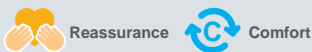

#### Keep back up all the time!

If one of the two indoor units malfunctions and stops its operation, the other starts backup operation so that users' comfort will not be compromised.

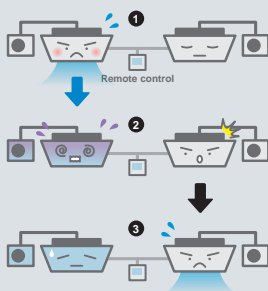

### Capacity backup control



#### Maintains users' comfort!

When the control system detects either of two units is operating with overload, the other unit cover the capacity.

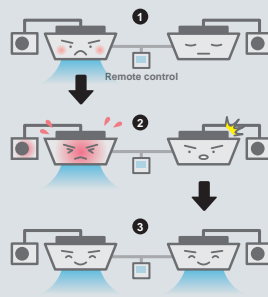

### New Rotational operation control



#### Energy saving and longer life!

By operating two indoor units alternately, their chronological changes are equalized. (The alternate operation cycle can be specified in a range from 1 to 999 hours in increments of 1 hours.)

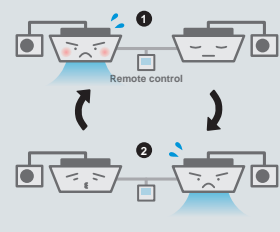

# REMOTE CONTROL

## Additional Functions of External Input / Output

The external input/output of indoor unit by remote controller can set input/output based on user's demand.



Remote surveillance system



Card key on-off

### External Input

CNT (1-6) CNTA (1-2)

Input On/Off  
Permission/Prohibition  
Cooling/Heating  
Emergency Stop

Set temp. shift  
Forced thermo-off  
IU operation stop  
Silent mode

Newly added

### External Output

CNT (New)

2 Output - Operation  
- Heating  
- Compressor ON (thermo-ON)

3 Output - Inspection

Cooling (defrosting)  
Fan operation  
Fan operation with Phi or Hi  
Fan operation with Me or Lo  
Defrosting (oil return in heating operation)  
Ventilation  
Heater ON  
Free cooling  
IU overload alarm

Newly added

## Silent Mode Control

The Outdoor unit is controlled with priority on quietness. Silent mode control must be set to the F1 or F2 switch. User can start/stop the silent mode control with a single tap of a button.

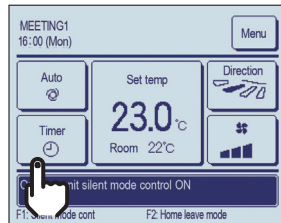
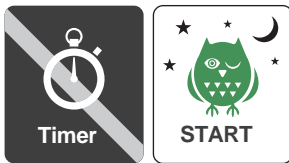

## Indoor Unit Capacity Display

Capacities of Indoor units connected to the RC-EX3A are displayed.

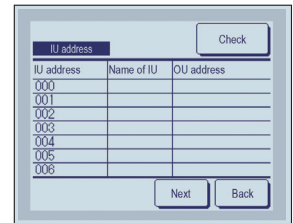
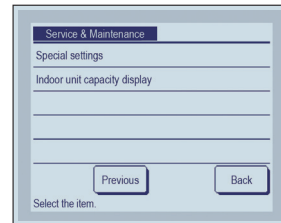

## Language Switching

User can select from the following languages and also switch them on the top display.

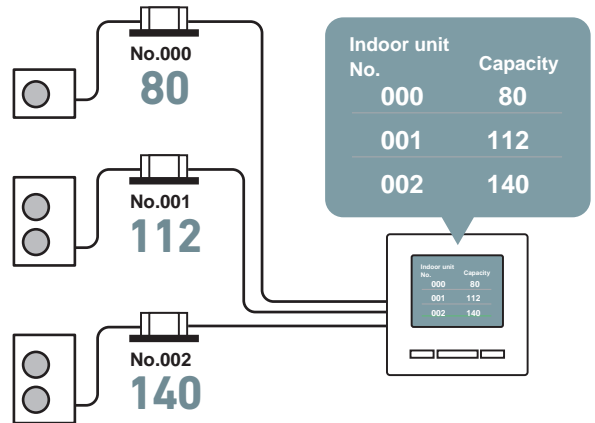
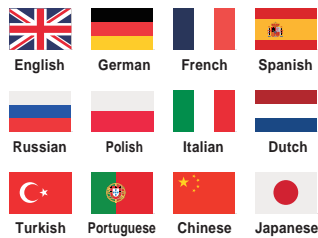
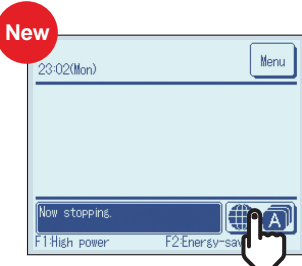

## Contact company & Error display

If any error occurs on the air conditioner, the "Unit protection stop" is indicated on the message display.



"Error"

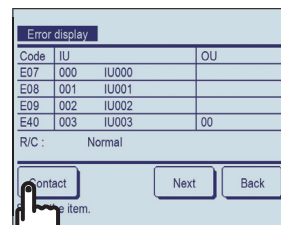
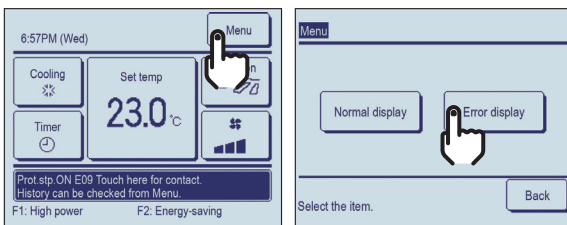



# Case Study : Commercial

Specific cases of FD series installation from Mitsubishi Heavy Industries Thermal Systems

## MHI aircon system recovers waste energy at Bristol Airport

A 375kW air conditioning installation from Mitsubishi Heavy Industries Thermal Systems has just checked in at Bristol Airport. Twenty multi-split systems from MHI's FD Micro Inverter range and 33 SAF fresh air heat exchange units service a hub of pre-boarding and arrivals areas plus a new two-storey walkway connection to the terminal building. MHI's FD Split and Multi Split Systems feature a cutting edge inverter controlled compressor that adjusts automatically to meet the precise demands of the indoor unit to save energy and reduce temperature fluctuations.

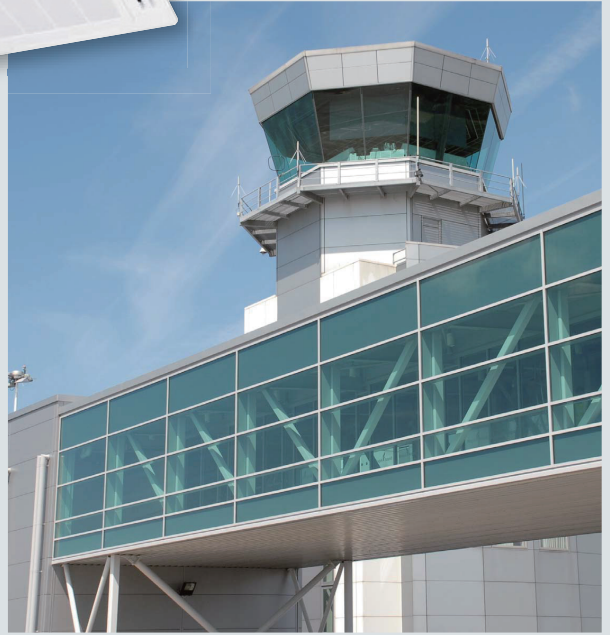



























## MHI aircon system offers bowling centres energy savings of up to 38%

High efficiency climate control from Mitsubishi Heavy Industries Thermal Systems has scored a strike at The Original Bowling Company, the UK's number one ten pin bowling operator. Outdated heating and cooling plant has been replaced with Mitsubishi Heavy Industries Thermal Systems heat pump systems at four Hollywood Bowl and AMF Bowling Centres so far, with further sites to follow in an ongoing refurbishment programme. The new systems employ MHI's inverter technology offering variable capacity control for consistent temperatures and energy savings of up to 38%.



# Product line up

## SINGLE SPLITS

FD series Type		Hyper Inverter 					
		HP	1.5	2.0	2.5	3.0	4.0
		kW	4.0	5.0	6.0	7.1	10.0
		Btu/h	13,600	17,100	20,500	24,200	34,100
		kcal/h	3,440	4,300	5,160	6,100	8,600
Ceiling Cassette	<b>New</b> <b>FDT</b> P24 4way 	 1 Phase	●	●	●		
	 1 Phase	●	●	●	●	●	
	 3 Phase					●	
Ceiling Cassette	<b>New</b> <b>FDTC</b> P36 4way compact 	 1 Phase	●	●	●		
	 1 Phase	●	●	●			
	 3 Phase						
Duct Connected	<b>FDU</b> P42 High Static pressure 	 1 Phase					
	 1 Phase				●	●	
	 3 Phase					●	
Duct Connected	<b>New</b> <b>FDUM</b> P48 Low/Middle Static pressure 	 1 Phase	●	●	●		
	 1 Phase	●	●	●	●	●	
	 3 Phase					●	
Wall Mounted	<b>SRK</b> P58 	 1 Phase					
		 1 Phase					
		 3 Phase					
Ceiling Suspended	<b>New</b> <b>FDE</b> P62 	 1 Phase	●	●	●		
	 1 Phase	●	●	●	●	●	
	 3 Phase					●	
Floor Standing	<b>FDF</b> P72 	1 Phase				●	●
		3 Phase					●





# Outdoor units

Our new advanced technology has high efficiency, strong heating and long piping. This contributes to the environmental protection through energy saving and permits installation of the units (4~6HP) considering a heating operation under temperature conditions down to -20°C and design flexibility has been improved by extension of piping length to 100m.

## Line up

HP	1.5	2	2.5	3	3.5	4	5	6	8	10
Hyper Inverter	●	●	●	●	-	●	●	●	-	-
Micro Inverter	-	-	-	-	-	●	●	●	●	●
Standard Inverter	-	-	-	●	●	●	-	-	-	-

## Hyper Inverter

New



SRC40ZSX-W1 (1.5HP)  
SRC50ZSX-W1 (2.0HP)  
SRC60ZSX-W1 (2.5HP)



SRC40ZSX-S (1.5HP)  
SRC50ZSX-S (2.0HP)  
SRC60ZSX-S (2.5HP)



FDC71VNX (3.0HP)



FDC100VNX/VSX (4.0HP)  
FDC125VNX/VSX (5.0HP)  
FDC140VNX/VSX (6.0HP)



## Micro Inverter

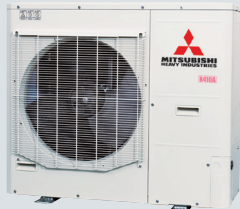

FDC100VNA/VSA (4.0HP)  
FDC125VNA/VSA (5.0HP)  
FDC140VNA/VSA (6.0HP)



FDC200VSA (8.0HP)



FDC250VSA (10.0HP)



## Standard Inverter



FDC71VNP (3.0HP)



FDC90VNP1 (3.5HP)

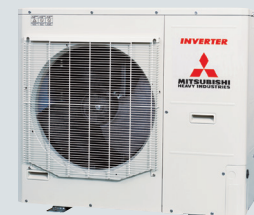

FDC100VNP (4.0HP)





# High Efficiency

Outdoor units high efficiency levels are achieved by our latest technologies, such as high efficient twin rotary compressors.

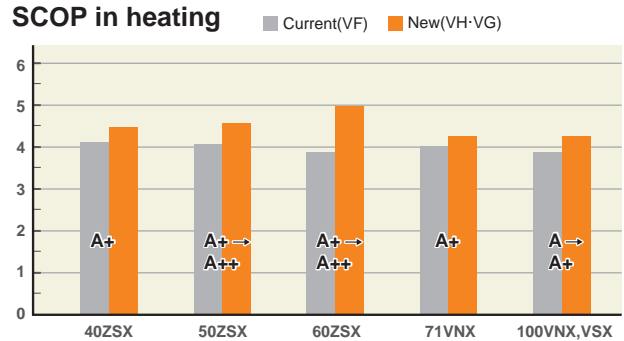
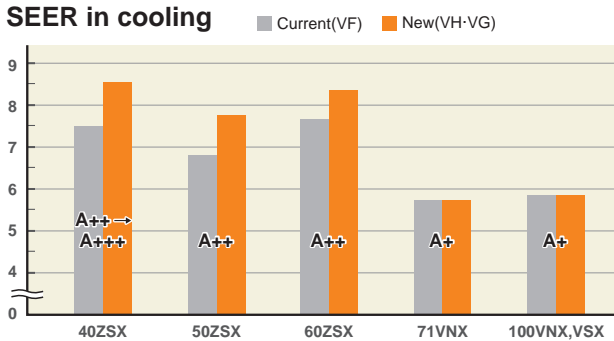

## Our Latest Technologies

All outdoor units

### 1 High efficiency performance on the DC twin rotary compressors

Employment of DC twin rotary compressor has enabled to utilize a high-speed range of up to 120 rps at the maximum to secure the required capacity.



DC twin rotary compressor

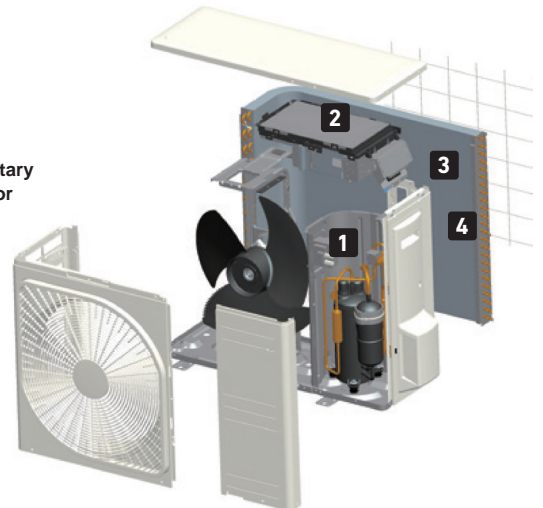

### 2 Vector inverter control

Optimum compressor control has been realized by employing the vector control\* and the starting current has been improved significantly compared with former models. Moreover, vibration has been reduced.

\* Vector control means a technique to realize an optimum control by converting the current wave to a smooth sinusoidal waveform

Better partial load efficiency



→

Centralized winding motor



### 3 Heat exchanger

Thanks to changing fin configuration from flat sheet to M shape fin. This high dimensional structure provides optimum balance of heat transfer and airflow.

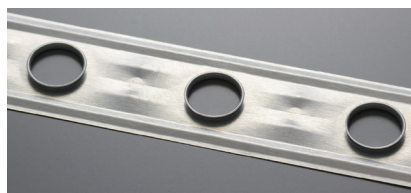

sectional structure

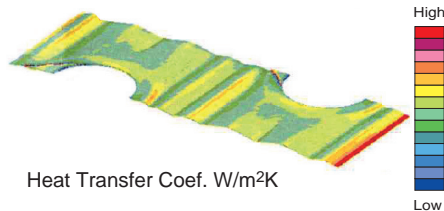

### 4 Blue fin

Due to application of blue coated fins (KS101) for the heat exchanger of new outdoor unit, corrosion resistance has been improved compared to current models.

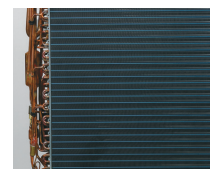

Hyper Inverter	3-6HP
Micro Inverter	4-10HP
Standard Inverter	3.5,4HP

# Outdoor units

## Leading Powerful Heating Capacity in the Industry

Hyper Inverter

Thanks to optimization of refrigeration control with use of electric expansion valve and development of twin rotary compressors, max heating capacity has been increased. Hyper Inverter series can reach the set temperature very quickly, keeping nominal heating capacity when outdoor temperature is -15°C. It is effective to be used even in cold area.

Temperature of supply air can reach 40°C in 4 minutes after start up under low temperature operation conditions (at both indoor and outdoor temperature of 2°C) and can reach 50°C in 8 minutes after that.

Heating capacity (in case of 5HP, 3Phase 380V)

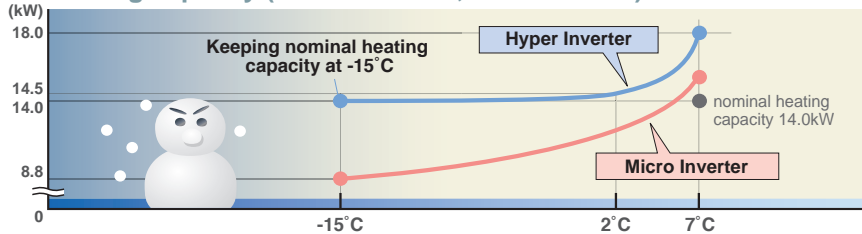

model name	nominal heating capacity (kW at outdoor temperature of 7°C)	heating capacity at outdoor temperature of -15°C
FDC100VSX(4HP, 3Phase 380V)	11.2kW	11.2kW
FDC125VSX(5HP, 3Phase 380V)	14.0kW	14.0kW
FDC140VSX(6HP, 3Phase 380V)	16.0kW	16.0kW

Please refer to our technical manual for installation conditions, operation range and heating/cooling capacities. (including 1Phase 220V)

Heating capacity

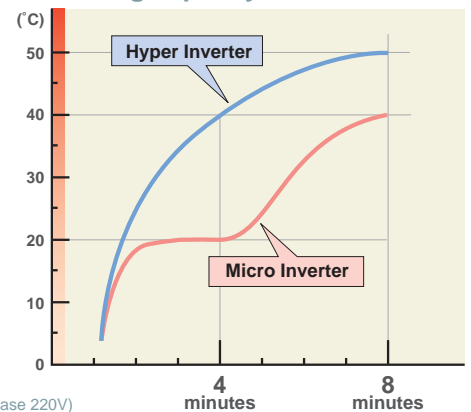

## Wide Range of Operation

Our new advanced technology has expanded the heating and cooling operation range. This permits installation of the units under a low outdoor temperature conditions down to -15°C/-20°C in heating operation and -15°C in cooling operation.

Heating Cooling

FDC 71/100/125/140 VN(S)X

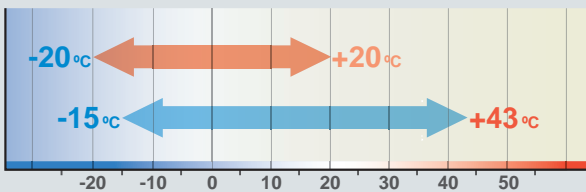

SRC 40/50/60 ZSX-W1(-S)

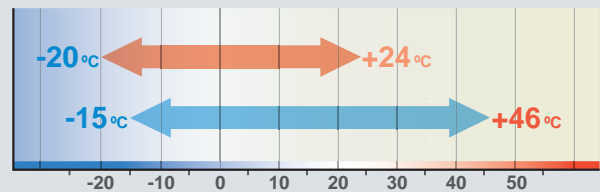

FDC 100/125/140/200/250 VN(S)A

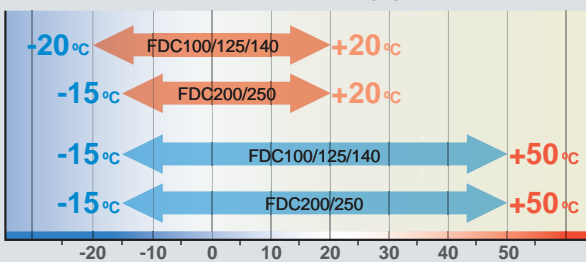

FDC 71/90/100 VNP

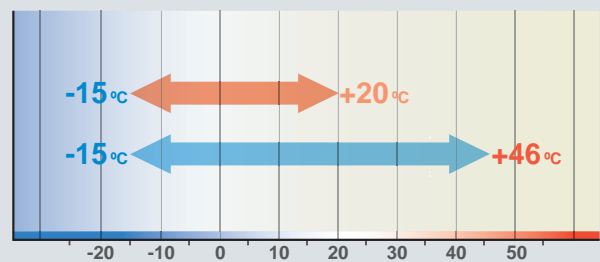

## Silent Mode Operation

All outdoor units

More quiet "silent mode" is possible.

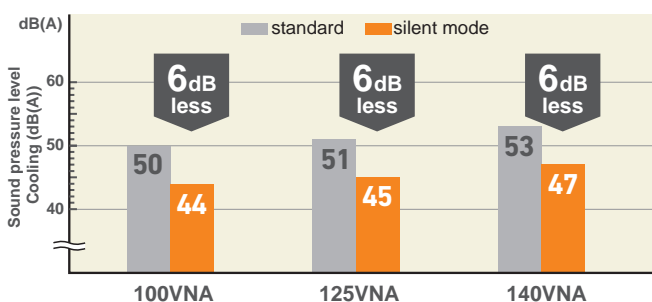

## Easy Transportation & Installation

Compact design of outdoor units.

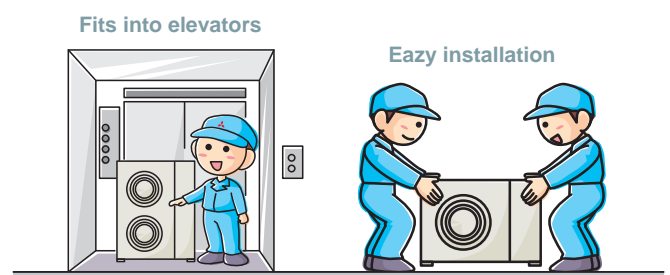



# Installation Workability

Enhanced installation workability thanks to the extended pipe length – longest level in the industry and precharged refrigerant.

**Long piping** (in case of Hyper 4~6HP)

**Wider variation of installation!**

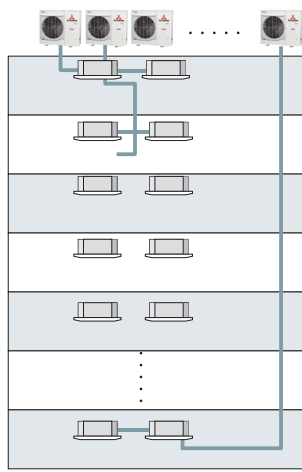
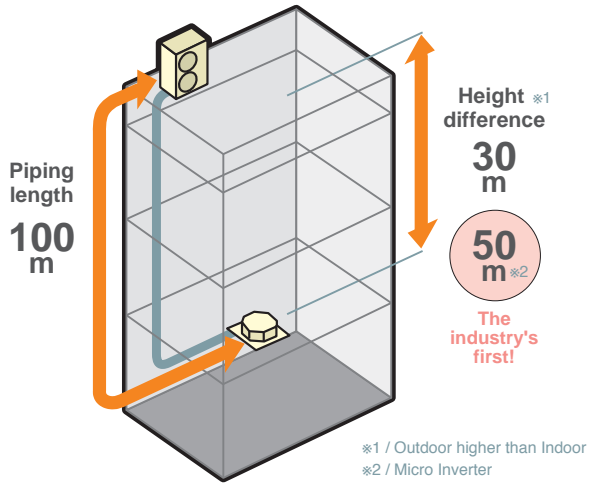

Hyper Inverter		
HP	Piping length	Height difference
1.5 ~ 2.5	30m	20m
3	50m	30m
4 ~ 6	100m	30m

Micro Inverter		
HP	Piping length	Height difference
4 ~ 6	50m	50m <sup>*</sup>
8 & 10	70m	30m

<sup>\*</sup> When the outdoor unit is installed at a position higher than the indoor unit by 30m or more, set SW5-2 on the control PCB to ON.

Standard Inverter		
HP	Piping length	Height difference
3 ~ 4	30m	20m

## Refrigerant precharged piping length extending to 30m

Refrigerant precharged piping length extends up to 30m. This eliminates the need to add refrigerant on site, which sets it free from trouble of excessive or insufficient charging of refrigerant, and allows carrying out the installation smoothly. <sup>\*</sup> Hyper inverter 1.5~2.5HP and Standard Inverter are up to 15m.

# Serviceability

Micro Inverter (10HP)

### Improved freedom of piping layout

1 Front, 2 Right, 3 Down, 4 Rear

135 (mm) previous vs 90 current

Hole size becomes 120% bigger.

### Wire insertion holes for fall prevention

### 2 Layer Construction

Thanks to control box structure with 2 layer construction using hinge connection, service and maintenance has been made much easier for inverter components.

### A transparent rain cover

Attached as a standard for easy maintenance.

### Fixing screws to service panel

Decreasing number of screws from 5 to 2, installation & service speed is improved.

5 → 2

# Monitoring Function

All outdoor units

To your PC monitoring and service tasks made simple with our service software ("Mente PC").

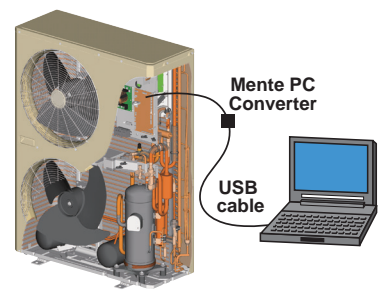

## Base heater kit (Option)

This kit is recommended to be used in an area where the lowest temperature drops below 0°C.



CW-H-E1

applied for

FDC71VN <sup>X</sup>	FDC200/250VSA
FDC100~140VN <sup>X</sup> ,VS <sup>X</sup>	FDC100VNP
FDC100~140VNA,VSA	

# Outdoor units

## ■ MULTI SYSTEM

# Twin / Triple / Double Twin Multi System

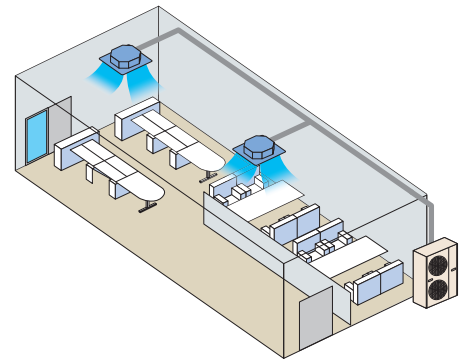

Up to Four indoor units can be connected to a single outdoor unit and simultaneously operated with a single remote control.  
By referring to the following table for applicable indoor units, select the same models and capacities.

### Combination of indoor units

Outdoor Unit	Hyper Inverter				Micro Inverter				
	FDC71VNX	FDC100VNX FDC100VSX	FDC125VNX FDC125VSX	FDC140VNX FDC140VSX	FDC100VNA FDC100VSA	FDC125VNA FDC125VSA	FDC140VNA FDC140VSA	FDC200VSA	FDC250VSA
Twin	40 + 40	50 + 50	60 + 60	71 + 71	50 + 50	60 + 60	71 + 71	100 + 100	125 + 125
Triple				50 + 50 + 50			50 + 50 + 50	71 + 71 + 71	
Double Twin								50+50+50+50	60+60+60+60

# V Multi System





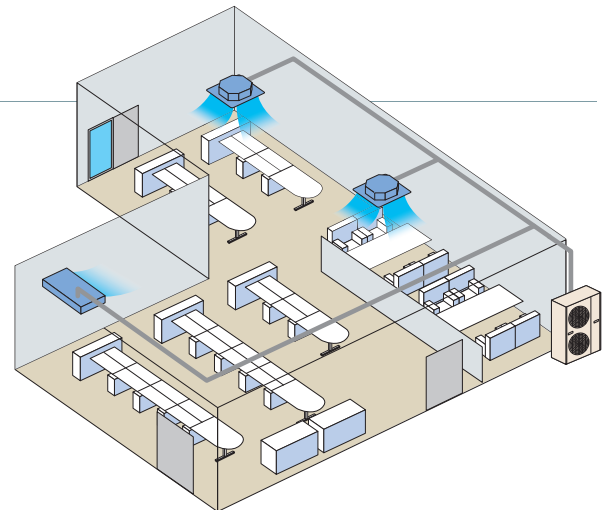

Ideal for the installation in large area and L-shaped rooms, the V Multi System has an extensive degree of flexibility in the selection of indoor units. Specifically, the selection of indoor units with different capacities in different types can be made.







### Combination of indoor units

Outdoor Unit	Hyper Inverter				Micro Inverter				
	FDC71VNX	FDC100VNX FDC100VSX	FDC125VNX FDC125VSX	FDC140VNX FDC140VSX	FDC100VNA FDC100VSA	FDC125VNA FDC125VSA	FDC140VNA FDC140VSA	FDC200VSA	FDC250VSA
Twin	40 + 40	50 + 50	60 + 60 50 + 71	71 + 71	50 + 50	60 + 60 50 + 71	71 + 71	100 + 100 71 + 125	125 + 125
Triple				50 + 50 + 50			50 + 50 + 50	71 + 71 + 71	60+60+125 71+71+100
Double Twin								50+50+50+50	60+60+60+60

### Applicable indoor units

Model	Capacity						
	40	50	60	71	100	125	
Twin / Triple Double Twin Multi System	New <b>FDT</b> 	●	●	●	●	●	●
	New <b>FDC</b> 	●	●	●			
	New <b>FDUM</b> 	●	●	●	●	●	●
	<b>SRK</b> 		●*	●*		●	

\* Hyper inverter combination only

Model	Capacity						
	40	50	60	71	100	125	
Twin / Triple Double Twin Multi System	New <b>FDE</b> 	●	●	●	●	●	●
	<b>FD</b> 				●	●	●
V Multi System	New <b>FDT</b> 	●	●	●	●	●	●
	New <b>FDE</b> 	●	●	●	●	●	●

## Decision of piping specification

Diagrams below show the application as samples. For further information, refer to TECHNICAL MANUAL.

### Twin type

Models **FDC71, FDC100~140, FDC200, FDC250**  
 [Branch pipe set : DIS-WA1G, DIS-WB1G]

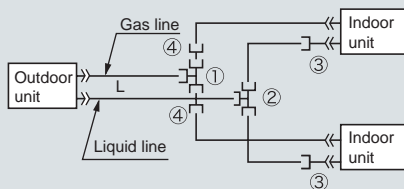

### Triple type

Model **FDC140, FDC200**  
 [Branch pipe set : DIS-TA1G, DIS-TB1G]

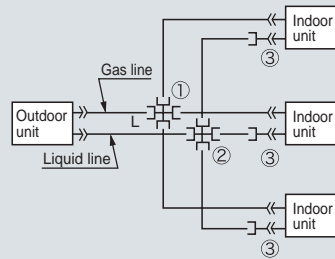

The indoor\_outdoor piping length differences among indoor units are less than 3m.

### Chart of shapes of branch piping parts

Branching pipe set type	Outdoor unit	Indoor unit combinations	Symbol		
			Branching pipe set for a gas pipe	Branching pipe set for a liquid pipe	Different diameter pipe joint
DIS-WA1G (Two-way branching set)	FDC71	40+40	①	②	③ Joint A: ID9.52, 2 pieces; Flare Joint (for indoor unit side connection) ④ Joint B: OD15.88, 2 pieces; ID12.7
	FDC100	50+50	①	②	
	FDC125	60+60			
	FDC140	50+71			
DIS-WB1G (Two-way branching set)	FDC200	100+100	①	②	④ Joint C: OD12.7, 1 piece; ID9.52
	FDC250	71+125			
	FDC250	125+125			
DIS-TA1G (Three-way branching set)	FDC140	50+50+50	①	②	③ Joint A: ID9.52, 3 pieces; Flare Joint (for indoor unit side connection)
			①	②	

Symbol ① to ④ in the drawing shows the symbols of branch piping parts in the chart respectively.

Branch piping should always be arranged to have level or perpendicular position.

### Notes

- (1) When 40-60 models of indoor units are applied to this combination, the reducer ③ supplied with the branch piping set should be used in order to reduce the liquid piping size from ø9.52mm to ø6.35mm at indoor unit side (flare connection). Accordingly be sure to select the liquid piping size ø9.52mm from branch to indoor unit.
- (2) The reducer ④ is for FDC71 and 100 models only.

ID stands for inner diameter and OD, outer diameter.

The branch piping (both gas and liquid lines) should always be arranged to have a level or perpendicular position.

#### 2-Way Branch

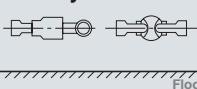

Mount — sections level with the floor.

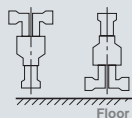

Mount — sections perpendicular to the floor.

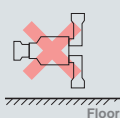

Floor

#### 3-Way Branch

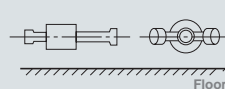

Floor

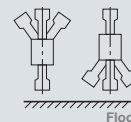

Floor

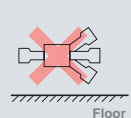























Floor



# Indoor units















## BENEFITS SUMMARY

		FDT	FDTC	FDU	FDUM	SRK	FDE	FDF	
									
<b>Cost</b> 	 <b>Inverter Technology</b> Inverter control technology functions at high efficiency with smooth operation from high speed to low speed. A smooth sine voltage wave is attained.	●	●	●	●	●	●	●	
	 <b>Energy-Saving</b> ※ Since the capacity is controlled automatically based on the outdoor temperature, energy can be saved without losing comfort.	●	●	●	●	●	●	●	●
	 <b>Home Leave Operation</b> This function ensures that when the room is unoccupied for long periods of time, the unit will maintain a moderate indoor temperature, avoiding extremely hot or cool temperatures.	●	●	●	●	●	●	●	●
	 <b>Set Temperature Auto Return</b> ※ This function allows you to program a preferred set temperature that the unit will return to each time it is operated.	●	●	●	●	●	●	●	●
<b>Comfort</b> 	 <b>Automatic Operation</b> This function automatically selects the required heating or cooling function based on the current room conditions.	●	●	●	●	●	●	●	
	 <b>Silent Operation</b> This function allows you to program periods where the unit will operate with reduced noise levels, perfect for night time and an uninterrupted sleep.	●	●	●	●	●	●	●	
	 <b>Motion Sensor</b> ※ This sensor detects human activity and shifts the temperature setting according to the amount of activity in the room.	● Option	● Option	● Option	● Option	●	● Option	●	
	 <b>Hi Power Operation</b> Use the high power function to quickly reach your optimum temperature level when you first turn on the unit. This function will operate for a maximum of 15 minutes before returning to normal operation.	●	●	●	●	●	●	●	
<b>Air Flow</b> 	 <b>Flap Control System</b> This function allows you to set the upper and lower limit positions of the flap at each air outlet individually, providing you with complete control over interior air flow.	●	●			●	●		
	 <b>Vertical Auto Swing</b> The vertical louvers on your unit will move up and down continuously during operation. This function allows you to set the up/down swing position of the louver to your preferred operation angle.	●	●			●	●	●	
	 <b>Draft Prevention Setting</b> ※ Draft Prevention setting provides a comfortable air flow without any draft feeling. Whether cooling or heating a room, the remote control can be used to instantly suppress any warm or cool drafts. This accurately assists how air flow is directed out of the indoor unit.	● Option	● Option						
	 <b>Automatic Fan Speed</b> The unit's on-board microcomputer continuously monitors the room's air temperature and adjusts the air flow automatically.	●	●	●	●	●	●	●	

When using RC-EX3A (Remote control), functions with symbol  are available.

However, for RC-E5 (Remote control), functions with  are not available.

FDT	FDTC	FDU	FDUM	SRK	FDE	FDF	FDT	FDTC	FDU	FDUM	SRK	FDE	FDF
													

		FDT	FDTC	FDU	FDUM	SRK	FDE	FDF
<b>Timer</b> 	 <b>Sleep Timer</b> This function allows you to set a pre-determined amount of time between 30 and 240 minutes that your unit will operate for before switching off.	●	●	●	●	●	●	●
	 <b>Peak-Cut Timer</b> ✖ This function lets you to preset the capacity limit during certain periods of the day, minimising energy consumption during peak billing times, thus reducing operation costs.	●	●	●	●	●	●	●
	 <b>Weekly Timer</b> Set your unit to turn on and off automatically on a weekly basis to suit your usual room usage on each day.	●	●	●	●	●	●	●
<b>Convenient</b> 	 <b>Function Switch</b> ✖ From the seven available functions on the unit, this function allows you to set two functions to operate automatically.	●	●	●	●	●	●	●
	 <b>Favourite Setting</b> ✖ Operation mode, set temperature, fan speed and air flow direction automatically adjust to the programmed favourite setting.	●	●	●	●	●	●	●
	 <b>Select the Language</b> ✖ Set the language to be displayed on the remote control.	●	●	●	●	●	●	●
	 <b>Air Filter</b> The air filter in the unit traps and removes airborne dust particles and other allergens to provide you with a clean air function.	●	●	Procure locally	● Option	●	●	●
	 <b>Filter Sign</b> This warning alerts you to when the filter needs to be cleaned.	●	●	●	●	●	●	●
	 <b>Outside Air Intake</b> This function provides clean fresh air into the room through the external air intake, avoiding the constant recycling of internal air.	●	●	●	●			
	 <b>Self Diagnostics</b> The internal microcomputer automatically runs a diagnostic of the system in the event of a malfunction. This enables your authorised dealer to isolate and repair any issues.	●	●	●	●	●	●	●
<b>Others</b>	 <b>Built in Drain Pump</b> The built-in drain pump, allows greater flexibility with installation, offering a great solution for applications with limited space.	●	●	● *1	●			
	 <b>Improved Serviceability</b> The fan unit (comprised of impeller and motor) is easily accessible from either the side or bottom of the unit and can be slid out for easy maintenance.			●	●			

\*1 : Except 200 • 250

# FDT

## Indoor Unit Ceiling Cassette -4way-

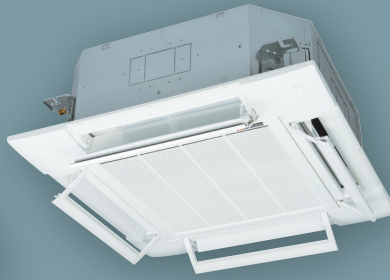

**New**

FDT 40/50/60/71/100/125/140

**GOOD DESIGN**

Draft Prevention Panel (Option)



Energy Saving



Home Leave



Hi Power



Silent Operation



Flap Control



Favourite Setting



### Remote control (option)

#### Wired



RC-EX3A



RC-E5



RCH-E3

#### Wireless



RCN-T-5AW-E2

\*Not all functions available with all remote control options.

## Draft Prevention Panel (Option)

Draft Prevention Panel prevents cold/hot draft being blown directly on the user. It is possible to set Draft Prevention Panel for each air outlet.

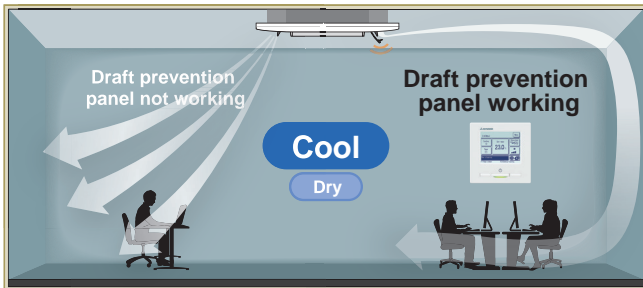

User can position Draft Prevention Panel panels by using the remote controller only (RC-EX3A, RCN-T-5AW-E2).

## Motion Sensor (Option)

Motion sensor is equipped in the panel corner and detects the presence/absence and activity of humans in a room to improve the comfort and energy saving performance of the unit.



LB-T-5W-E

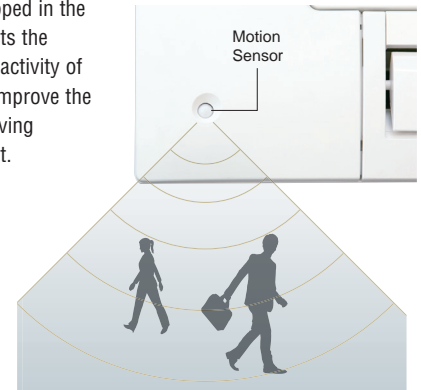

## Individual Flap Control System

According to room conditions, four directions of air flow can be controlled individually by utilizing the flap control system. Individual flap control is available even after installation.

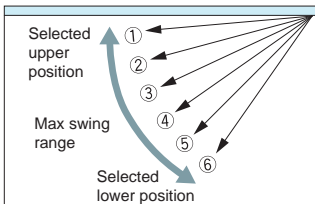
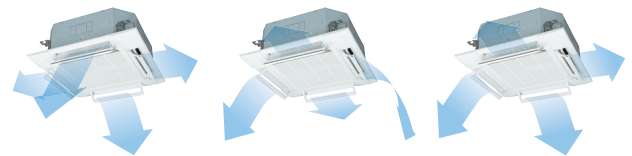

Flap can swing within an upper and lower flap range position within can be selected with a wired remote control.

※The wireless remote control is not applicable to the Individual flap control system.

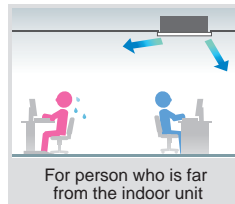

For person who is far from the indoor unit

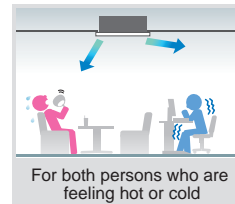

For both persons who are feeling hot or cold

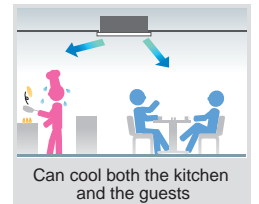

Can cool both the kitchen and the guests



## Quieter Noise

New technology has realised quiet noise (in cooling) with keeping capacity and comfort.

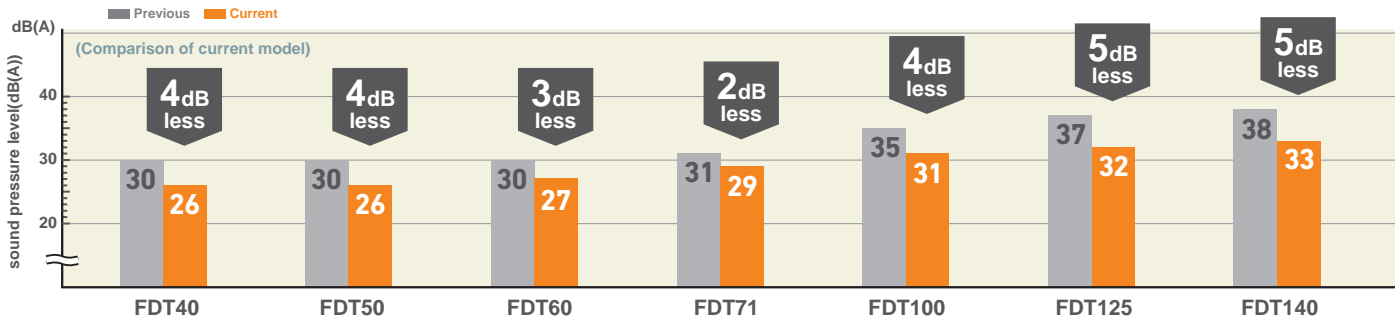

## Panel Select Pattern (Option)

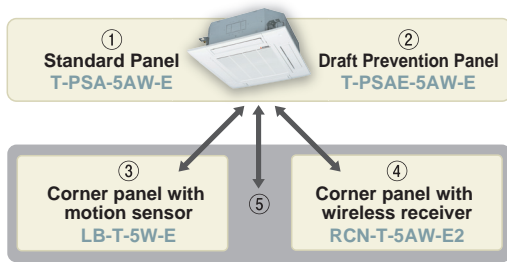

8 patterns of panel are available.

- ① Standard Panel only
- ①+③ Standard Panel with corner panel with motion sensor
- ①+④ Standard Panel with corner panel with wireless receiver
- ①+⑤ Standard Panel with corner panel with motion sensor & corner panel with wireless receiver
- ② Draft Prevention Panel only
- ②+③ Draft Prevention Panel with corner panel with motion sensor
- ②+④ Draft Prevention Panel with corner panel with wireless receiver
- ②+⑤ Draft Prevention Panel with corner panel with motion sensor & corner panel with wireless receiver

Installation position of Wireless kit and Motion sensor kit

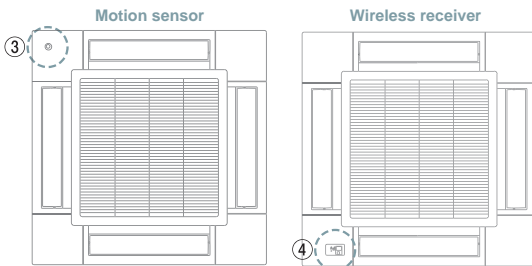

\*Wireless receiver and Motion sensor can be installed to the position as shown

## 850mm Drain Pump

Drain can be discharged upwards by 850mm from the ceiling surface. It allows a piping layout with a high degree of freedom. Depending on the installation location and 185mm flexible hose as a standard equipment supports easy workability.

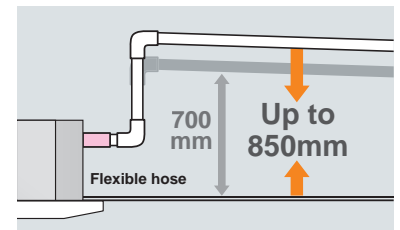

## OUTDOOR UNIT

	Hyper Inverter		Hyper Inverter	
SRC • FDC	40~60ZSX-W1	40~60ZSX-S	71VNX	100~140VN(S)X
model				
Chargeless	15m	15m	30m	
Height x Width x Depth (mm)	640 x 800(+71) x 290	640 x 800(+71) x 290	750 x 880(+88) x 340	1,300 x 970 x 370

	Micro Inverter			Standard Inverter		
FDC	100~140VN(S)A	200VSA	250VSA	71VNP	90VNP1	100VNP
model						
Chargeless	30m			15m		
Height x Width x Depth (mm)	845 x 970 x 370	1,300 x 970 x 370	1,505 x 970 x 370	640 x 800(+71) x 290	750 x 880(+88) x 340	845 x 970 x 370

Easy and quick installation and maintenance

# Serviceability & Workability

**Quick positioning !**

## Indoor unit is easily positioned and installed

**1 Adjustable easier positioning of unit by new slits.** FDT

New shape of slit is suitable to install the unit with more flexibility, according to many kinds of suspending bolt pitch on site. Any rectangular or squared pitch of suspending bolts are available with this slit.

Compatible with both square or rectangular bolt pitch



**2 New slit in panel allows easier installation on site.** FDT  
FDTC

Flexible positioning is available, which helps adjusting the direction of panel according to lines or pattern on the ceiling.

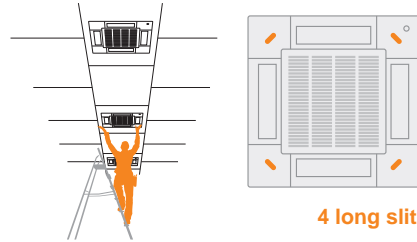

4 long slits are available.

## Quick installation and maintenance

**1 Easy access to component part for easy maintenance.** FDT

1. The control box and bell mouth can be removed together.

2. Easy access to impeller and fan motor.

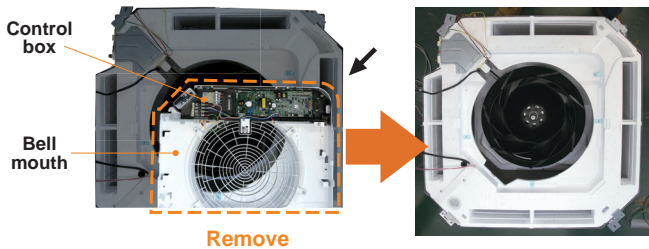

**2 New shape of path of wiring.** FDT

New shape of path gives easy wiring work for installation.

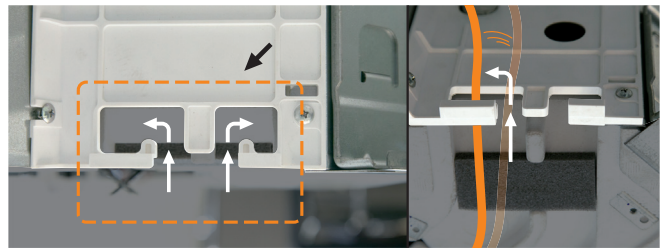

Easy wiring work

**3 No need to remove screws to take off the controller cover.** FDT

It is possible to loose and slide open the cover without remove of the screws. This prevents the cover from falling and damaging to stuffs on site.

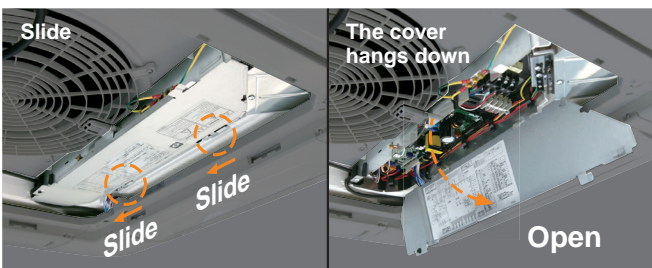

No need to remove screws



**4 Safer installation by stopper of washer.** FDT  
FDTC

When unit is installed with hook between washers, this stopper helps to install the unit safely, without adjusting washer.

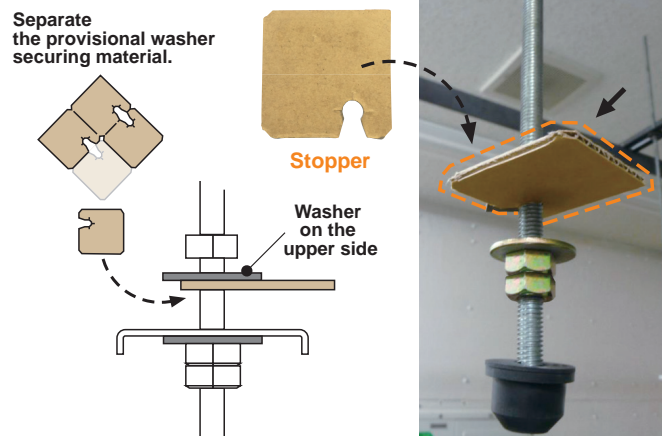



Builder



Maintenance

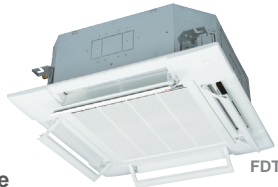

FDT



FDTC

For smooth and easy working

### Good help for installation and maintenance

#### 1 Easy and flexible hook to remove the filter FDT FDTC

Hook of soft material helps to remove the filter without dust spreading.

Press the filter tab to the outside and remove the filter.

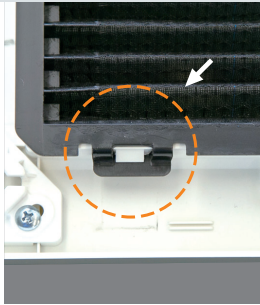

Soft material

#### 2 Securely fix the corner lid by strap FDT

The direction of the strap hook part has been changed from longitudinal to lateral. Furthermore, a barb has been added to the hook pin to prevent the strap from coming off.

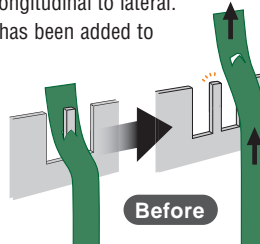

After

Easy to hook but not easy to loose

#### 3 Drain-up-lift increases up to 850 mm FDT FDTC

The drain can be lifted up to 850 mm from the ceiling surface.

	Previous	New
FDT	700	850
FDTC	600	850

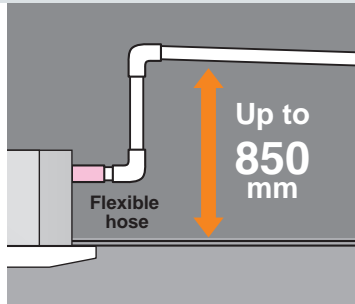

Up to 850 mm

#### 4 New port to check drain water flow FDT

A water supply port has been provided in the piping lid for easier testing of the drain water flow. (The port is usually sealed with a rubber cap.)

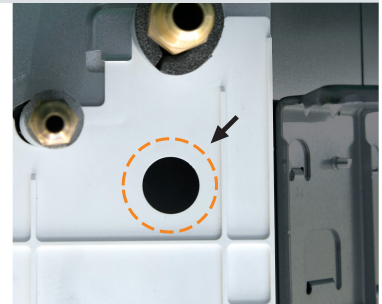

#### 5 Re-use of packages during construction work FDT FDTC

Package material (carton) help to protect the unit from unexpected welding spatter or coming dust to the new unit.

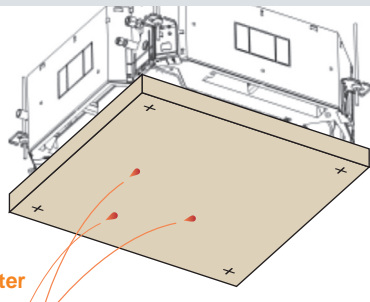

Spatter

#### 6 More flexible outlet for ducting FDT FDTC

Both  $\phi 125$  and  $\phi 200$  (oval shaped) are available.

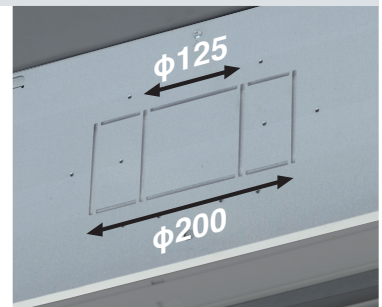
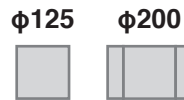

#### 7 Easy check of drain pan FDT FDTC

Easy check of drain pan condition is available by removing corner lid only.

Remove corner lid. Remove drain cap cover and check the condition. It is necessary to clean-up, firstly remove the rubber stopper to drain water out and secondly remove the drain cap.

Clean up the area around the drain pump port.

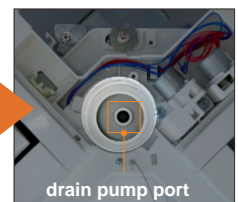
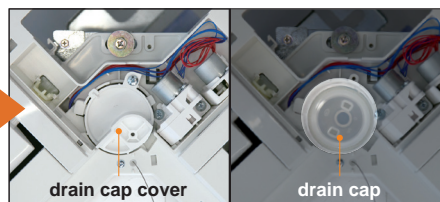
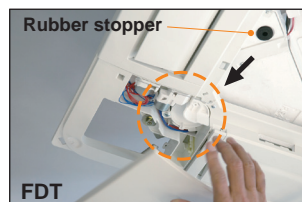



# DIMENSIONS (Unit:mm) - FDT -

## Models FDT40VH, 50VH, 60VH, 71VG

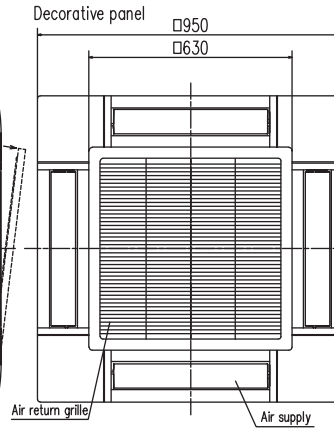
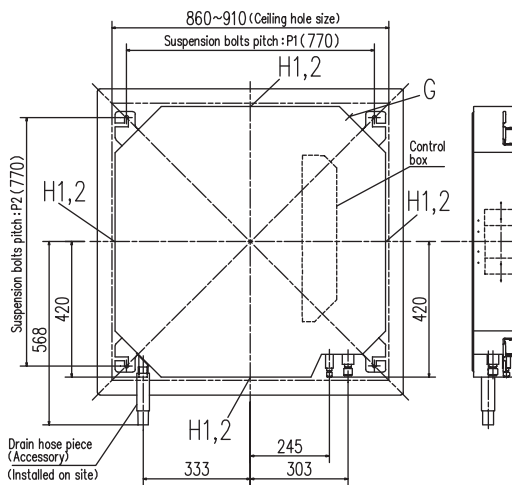

Symbol	Model	Content
	40,50,60	71
A	Gas piping	φ127 (1/2") (Flare) φ158.8 (5/8") (Flare)
B	Liquid piping	φ6.35 (1/4") (Flare) φ9.52 (3/8") (Flare)
C	Drain piping	VP25 (O.D.32)
D	Hole for wiring	
F	Suspension bolts	(M10 or M8)
G	Outside air opening for ducting	(Knock out)
H1	Air outlet opening for ducting	φ125 (Knock out)
H2		φ200 (Knock out)

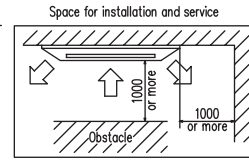

Make a space of 5000 or more between the units when installing more than one.

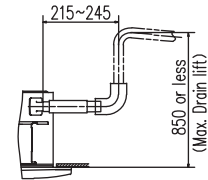
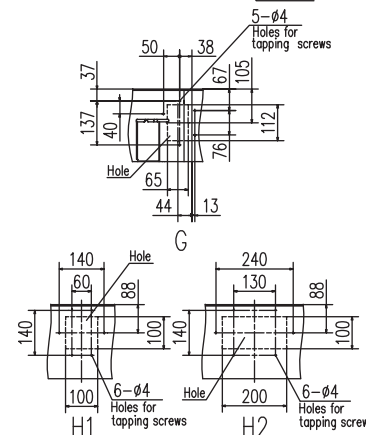
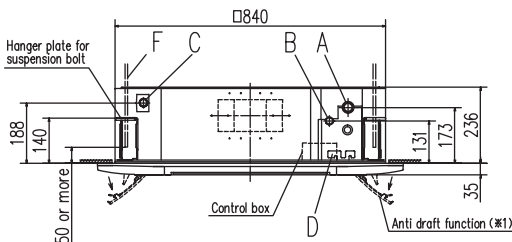

- Notes (1) The model name label is attached to the control box lid.  
 (2) Suspension bolt pitch P1,P2 is adjustable by a pattern of the right table.  
 (3) Section 1 (#1) is provided on the panel T-PSAE-5AW-E only.

Symbol Pattern	P1	P2
1	770	725~770
2	770~800	725

## Models FDT100VG, 125VG, 140VG

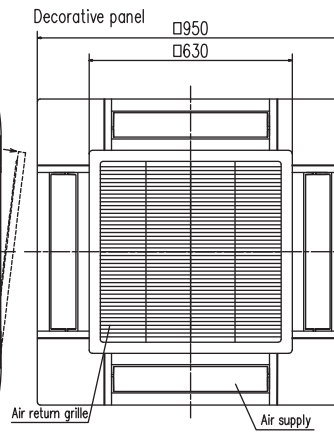
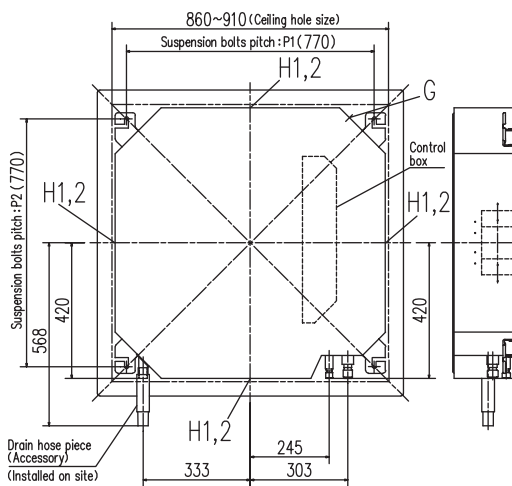

Symbol	Content
A	Gas piping
B	Liquid piping
C	Drain piping
D	Hole for wiring
F	Suspension bolts
G	Outside air opening for ducting
H1	Air outlet opening for ducting
H2	

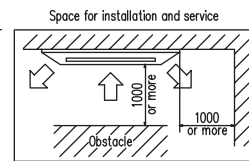

Make a space of 5000 or more between the units when installing more than one.

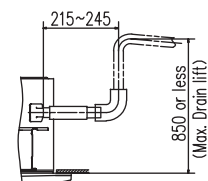
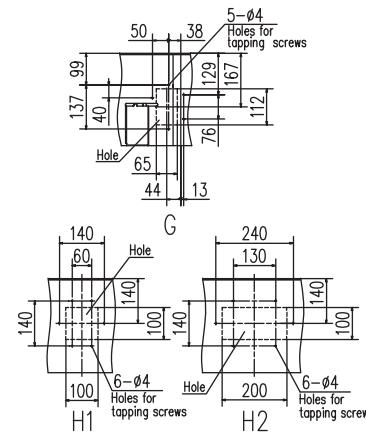
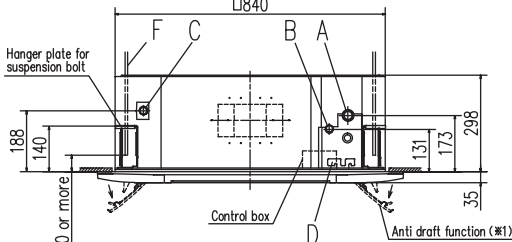

- Notes (1) The model name label is attached to the control box lid.  
 (2) Suspension bolt pitch P1,P2 is adjustable by a pattern of the right table.  
 (3) Section 1 (#1) is provided on the panel T-PSAE-5AW-E only.

Symbol Pattern	P1	P2
1	770	725~770
2	770~800	725

## SPECIFICATIONS -FDT-

R32		Hyper Inverter		
Set model name		FDT40ZSXW1VH	FDT50ZSXW1VH	FDT60ZSXW1VH
Indoor unit		FDT40VH	FDT50VH	FDT60VH
Outdoor unit		SRC40ZSX-W1	SRC50ZSX-W1	SRC60ZSX-W1
Power source		1 Phase 220-240V, 50Hz / 220V, 60Hz		
Nominal cooling capacity (Min~Max)		kW 4.0 ( 1.1 ~ 4.7 )	5.0 ( 1.1 ~ 5.6 )	5.6 ( 1.1 ~ 6.3 )
Nominal heating capacity (Min~Max)		kW 4.5 ( 0.6 ~ 5.4 )	5.4 ( 0.6 ~ 6.3 )	6.7 ( 0.6 ~ 6.7 )
Power consumption		Cooling/Heating kW 0.890 / 1.03	1.29 / 1.31	1.33 / 1.56
EER/COP		Cooling/Heating 4.49 / 4.37	3.88 / 4.12	4.21 / 4.29
Inrush current		A 5	5	5
Max. current		15	15	15
Sound power level*1	Indoor	Cooling/Heating	50 / 50	55 / 56
	Outdoor	Cooling/Heating	63 / 62	63 / 62
Sound pressure level*1	Indoor	Cooling (P-Hi/Hi/Me/Lo)	36 / 33 / 30 / 26	41 / 33 / 30 / 26
		Heating (P-Hi/Hi/Me/Lo)	36 / 33 / 28 / 20	42 / 33 / 28 / 20
	Outdoor	Cooling/Heating	52 / 50	52 / 50
		Cooling/Heating	52 / 50	52 / 50
Air flow	Indoor	Cooling (P-Hi/Hi/Me/Lo)	19 / 16 / 13 / 10	22 / 16 / 13 / 10
		Heating (P-Hi/Hi/Me/Lo)	19 / 16 / 13 / 10	22 / 16 / 13 / 10
	Outdoor	Cooling/Heating	39 / 33	39 / 33
Exterior dimensions	Indoor	HeightxWidthxDepth	Unit: 236 x 840 x 840 Panel: 35 x 950 x 950	
	Outdoor	HeightxWidthxDepth	640 x 800(+71) x 290	
Net weight	Indoor		24(Unit:19 Standard Panel:5)	
	Outdoor		26(Unit:21 Standard Panel:5)	
Ref.piping size	Liquid/Gas	ømm	6.35(1/4") / 12.7(1/2")	
Refrigerant line (one way) length		m	Max.30	
Vertical height differences		Outdoor is higher/lower	Max.20 / Max.20	
Outdoor operating temperature range	Cooling	°C	-15~46*2	
	Heating	°C	-20~24	
Panel			T-PSA-5AW-E, T-PSAE-5AW-E	
Air filter, Q'ty			Pocket plastic net x 1(Washable)	
Remote control (option)			wired:RC-EX3A, RC-E5, RCH-E3 wireless:RCN-T-5AW-E2	

### NOTES:

The data are measured under the following conditions(ISO-T1,H1).

Cooling:Indoor temp. of 27°CDB, 19°CWB, and outdoor temp. of 35°CDB. Heating:Indoor temp. of 20°CDB, and outdoor temp. of 7°CDB, 6°CWB.

\*1 : Indicates the value in an anechoic chamber. During operation these values are somewhat higher due to ambient conditions.

\*2 : If a cooling operation is conducted when the outdoor air temperature is -5°C or lower, the outdoor unit should be installed at a place where it is not influenced by natural wind. If wind blows, the low pressure will drop and compressor frequency will increase, this will cause the capacity to drop and may cause the unit to break down.

R410A		Hyper Inverter			
Set model name		FDT40ZSXVH	FDT50ZSXVH	FDT60ZSXVH	FDT71VNXVG
Indoor unit		FDT40VH	FDT50VH	FDT60VH	FDT71VG
Outdoor unit		SRC40ZSX-S	SRC50ZSX-S	SRC60ZSX-S	FDC71VNX
Power source		1 Phase 220-240V, 50Hz / 220V, 60Hz			
Nominal cooling capacity (Min~Max)		kW 4.0 ( 1.1 ~ 4.7 )	5.0 ( 1.1 ~ 5.6 )	5.6 ( 1.1 ~ 6.3 )	7.1 ( 3.2 ~ 8.0 )
Nominal heating capacity (Min~Max)		kW 4.5 ( 0.6 ~ 5.4 )	5.4 ( 0.6 ~ 6.3 )	6.7 ( 0.6 ~ 7.1 )	8.0 ( 3.6 ~ 9.0 )
Power consumption		Cooling/Heating kW 0.93 / 1.03	1.29 / 1.31	1.52 / 1.56	1.94 / 1.91
EER/COP		Cooling/Heating 4.30 / 4.37	3.88 / 4.12	3.68 / 4.29	3.66 / 4.19
Inrush current		A 5	5	5	5
Max. current		12	15	15	17
Sound power level*1	Indoor	Cooling/Heating	50 / 50	55 / 56	58 / 59
	Outdoor	Cooling/Heating	63 / 63	63 / 63	65 / 64
Sound pressure level*1	Indoor	Cooling (P-Hi/Hi/Me/Lo)	36 / 33 / 30 / 26	41 / 33 / 30 / 26	44 / 34 / 30 / 27
		Heating (P-Hi/Hi/Me/Lo)	36 / 33 / 28 / 20	42 / 33 / 28 / 20	44 / 34 / 30 / 23
	Outdoor	Cooling/Heating	50 / 49	50 / 49	52 / 52
		Cooling/Heating	50 / 49	50 / 49	52 / 52
Air flow	Indoor	Cooling (P-Hi/Hi/Me/Lo)	19 / 16 / 13 / 10	22 / 16 / 13 / 10	26 / 17 / 14 / 11
		Heating (P-Hi/Hi/Me/Lo)	19 / 16 / 13 / 10	22 / 16 / 13 / 10	26 / 17 / 14 / 11
	Outdoor	Cooling/Heating	36 / 33	39 / 33	41.5 / 39
Exterior dimensions	Indoor	HeightxWidthxDepth	Unit: 236 x 840 x 840 Panel: 35 x 950 x 950		
	Outdoor	HeightxWidthxDepth	640 x 800(+71) x 290		750 x 880(+88) x 340
Net weight	Indoor		24(Unit:19 Standard Panel:5)		26(Unit:21 Standard Panel:5)
	Outdoor		45		60
Ref.piping size	Liquid/Gas	ømm	6.35(1/4") / 12.7(1/2")		
Refrigerant line (one way) length		m	Max.30		
Vertical height differences		Outdoor is higher/lower	Max.20 / Max.20		
Outdoor operating temperature range	Cooling	°C	-15~46*2		
	Heating	°C	-20~24		
Panel			T-PSA-5AW-E, T-PSAE-5AW-E		
Air filter, Q'ty			Pocket plastic net x 1(Washable)		
Remote control (option)			wired:RC-EX3A, RC-E5, RCH-E3 wireless:RCN-T-5AW-E2		

### NOTES:

The data are measured under the following conditions(ISO-T1).

Cooling:Indoor temp. of 27°CDB, 19°CWB, and outdoor temp. of 35°CDB. Heating:Indoor temp. of 20°CDB, and outdoor temp. of 7°CDB, 6°CWB.

\*1 : Indicates the value in an anechoic chamber. During operation these values are somewhat higher due to ambient conditions.

\*2 : If a cooling operation is conducted when the outdoor air temperature is -5°C or lower, the outdoor unit should be installed at a place where it is not influenced by natural wind. If wind blows, the low pressure will drop and compressor frequency will increase, this will cause the capacity to drop and may cause the unit to break down.

## SPECIFICATIONS -FDT-

R410A		Hyper Inverter		
Set model name		FDT100VNXVG	FDT125VNXVG	FDT140VNXVG
Indoor unit		FDT100VG	FDT125VG	FDT140VG
Outdoor unit		FDC100VNX	FDC125VNX	FDC140VNX
Power source		1 Phase 220-240V, 50Hz / 220V, 60Hz		
Nominal cooling capacity (Min-Max)		kW 10.0 ( 4.0 ~ 11.2 )	12.5 ( 5.0 ~ 14.0 )	14.0 ( 5.0 ~ 16.0 )
Nominal heating capacity (Min-Max)		kW 11.2 ( 4.0 ~ 12.5 )	14.0 ( 4.0 ~ 17.0 )	16.0 ( 4.0 ~ 18.0 )
Power consumption		Cooling/Heating kW 2.50 / 2.58	3.42 / 3.43	4.26 / 4.20
EER/COP		Cooling/Heating 4.00 / 4.34	3.65 / 4.08	3.29 / 3.81
Inrush current		A 5	5	5
Max. current		24	26	26
Sound power level*1	Indoor	Cooling/Heating 63 / 63	64 / 64	64 / 64
	Outdoor	Cooling/Heating 70 / 70	70 / 70	72 / 72
Sound pressure level*1	Indoor	Cooling (P-Hi/Hi/Me/Lo) dB(A) 48 / 39 / 37 / 31	49 / 41 / 39 / 32	49 / 42 / 39 / 33
	Outdoor	Heating (P-Hi/Hi/Me/Lo) 48 / 39 / 37 / 31	49 / 41 / 39 / 32	49 / 42 / 39 / 33
Air flow	Indoor	Cooling (P-Hi/Hi/Me/Lo) m³/min 37 / 26 / 23 / 17	38 / 28 / 25 / 18	38 / 29 / 26 / 19
	Outdoor	Heating (P-Hi/Hi/Me/Lo) 37 / 26 / 23 / 17	38 / 28 / 25 / 18	38 / 29 / 26 / 19
Exterior dimensions	Indoor	Unit: 298 x 840 x 840 Panel: 35 x 950 x 950		
	Outdoor	1,300 x 970 x 370		
Net weight	Indoor	30(Unit:25 Standard Panel:5)		
	Outdoor	105		
Ref.piping size	Liquid/Gas	ømm 9.52(3/8") / 15.88(5/8")		
Refrigerant line (one way) length		m Max.100		
Vertical height differences		m Max.30 / Max.15		
Outdoor operating temperature range	Cooling	°C -15~43*2		
	Heating	-20~20		
Panel		T-PSA-5AW-E, T-PSAE-5AW-E		
Air filter, Q'ty		Pocket plastic net x 1(Washable)		
Remote control (option)		wired:RC-EX3A, RC-E5, RCH-E3 wireless:RCN-T-5AW-E2		

R410A		Hyper Inverter		
Set model name		FDT100VSXVG	FDT125VSXVG	FDT140VSXVG
Indoor unit		FDT100VG	FDT125VG	FDT140VG
Outdoor unit		FDC100VSX	FDC125VSX	FDC140VSX
Power source		3 Phase 380-415V, 50Hz / 380V, 60Hz		
Nominal cooling capacity (Min-Max)		kW 10.0 ( 4.0 ~ 11.2 )	12.5 ( 5.0 ~ 14.0 )	14.0 ( 5.0 ~ 16.0 )
Nominal heating capacity (Min-Max)		kW 11.2 ( 4.0 ~ 16.0 )	14.0 ( 4.0 ~ 18.0 )	16.0 ( 4.0 ~ 20.0 )
Power consumption		Cooling/Heating kW 2.50 / 2.58	3.42 / 3.43	4.26 / 4.20
EER/COP		Cooling/Heating 4.00 / 4.34	3.65 / 4.08	3.29 / 3.81
Inrush current		A 5	5	5
Max. current		15	15	15
Sound power level*1	Indoor	Cooling/Heating 63 / 63	64 / 64	64 / 64
	Outdoor	Cooling/Heating 70 / 70	70 / 70	72 / 72
Sound pressure level*1	Indoor	Cooling (P-Hi/Hi/Me/Lo) dB(A) 48 / 39 / 37 / 31	49 / 41 / 39 / 32	49 / 42 / 39 / 33
	Outdoor	Heating (P-Hi/Hi/Me/Lo) 48 / 39 / 37 / 31	49 / 41 / 39 / 32	49 / 42 / 39 / 33
Air flow	Indoor	Cooling (P-Hi/Hi/Me/Lo) m³/min 39 / 26 / 23 / 17	38 / 28 / 25 / 18	38 / 29 / 26 / 19
	Outdoor	Heating (P-Hi/Hi/Me/Lo) 39 / 26 / 23 / 17	38 / 28 / 25 / 18	38 / 29 / 26 / 19
Exterior dimensions	Indoor	Unit: 298 x 840 x 840 Panel: 35 x 950 x 950		
	Outdoor	1,300 x 970 x 370		
Net weight	Indoor	30(Unit:25 Standard Panel:5)		
	Outdoor	105		
Ref.piping size	Liquid/Gas	ømm 9.52(3/8") / 15.88(5/8")		
Refrigerant line (one way) length		m Max.100		
Vertical height differences		m Max.30 / Max.15		
Outdoor operating temperature range	Cooling	°C -15~43*2		
	Heating	-20~20		
Panel		T-PSA-5AW-E, T-PSAE-5AW-E		
Air filter, Q'ty		Pocket plastic net x 1(Washable)		
Remote control (option)		wired:RC-EX3A, RC-E5, RCH-E3 wireless:RCN-T-5AW-E2		

### NOTES:

The data are measured under the following conditions(ISO-T1).  
 Cooling:Indoor temp. of 27°CDB, 19°CWB, and outdoor temp. of 35°CDB. Heating:Indoor temp. of 20°CDB, and outdoor temp. of 7°CDB, 6°CWB.  
 \*1 : Indicates the value in an anechoic chamber. During operation these values are somewhat higher due to ambient conditions.  
 \*2 : If a cooling operation is conducted when the outdoor air temperature is -5°C or lower, the outdoor unit should be installed at a place where it is not influenced by natural wind. If wind blows, the low pressure will drop and compressor frequency will increase, this will cause the capacity to drop and may cause the unit to break down.  
 \*3 : The values are for one indoor unit operation. (Multi system only)



The values are for simultaneous Multi operation.

R410A		Hyper Inverter				
Set model name		FDT71VNXPVH	FDT100VNXPVH	FDT125VNXPVH	FDT140VNXPVG	FDT140VNXTVH
		Twin			Triple	
Indoor unit		FDT40VH x 2	FDT50VH x 2	FDT60VH x 2	FDT71VG x 2	FDT50VH x 3
Outdoor unit		FDC71VNX	FDC100VNX	FDC125VNX	FDC140VNX	FDC140VNX
Power source		1 Phase 220-240V, 50Hz / 220V, 60Hz				
Nominal cooling capacity (Min~Max)	kW	7.1 (3.2 ~ 8.0)	10.0 (4.0 ~ 11.2)	12.5 (5.0 ~ 14.0)	14.0 (5.0 ~ 16.0)	14.0 (5.0 ~ 16.0)
Nominal heating capacity (Min~Max)	kW	8.0 (3.6 ~ 9.0)	11.2 (4.0 ~ 12.5)	14.0 (4.0 ~ 17.0)	16.0 (4.0 ~ 18.0)	16.0 (4.0 ~ 18.0)
Power consumption	Cooling/Heating kW	1.85 / 1.99	2.56 / 2.67	3.26 / 3.22	3.88 / 3.74	3.93 / 4.00
EER/COP	Cooling/Heating	3.84 / 4.02	3.91 / 4.19	3.83 / 4.35	3.61 / 4.28	3.56 / 4.00
Inrush current		5	5	5	5	5
Max. current	A	17	24	26	26	26
Sound power level*1	Indoor <sup>3</sup>	Cooling/Heating	50 / 50	55 / 56	58 / 59	62 / 62
	Outdoor	Cooling/Heating	66 / 66	70 / 70	70 / 70	72 / 72
Sound pressure level*1	Indoor <sup>3</sup>	Cooling (P-Hi/Hi/Me/Lo)	36 / 33 / 30 / 26	41 / 33 / 30 / 26	44 / 34 / 30 / 27	46 / 35 / 34 / 29
	Outdoor	Heating (P-Hi/Hi/Me/Lo)	36 / 33 / 28 / 20	42 / 33 / 28 / 20	44 / 34 / 30 / 23	46 / 35 / 34 / 29
Air flow	Indoor <sup>3</sup>	Cooling/Heating	51 / 48	48 / 50	48 / 50	49 / 52
	Outdoor	Cooling/Heating	19 / 16 / 13 / 10	22 / 16 / 13 / 10	26 / 17 / 14 / 11	28 / 18 / 15 / 12
Exterior dimensions	Indoor	HeightxWidthxDepth	Unit: 236 x 840 x 840 Panel: 35 x 950 x 950			
	Outdoor		750 x 880(+88) x 340 1,300 x 970 x 370			
Net weight	Indoor		24(Unit:19 Standard Panel:5)		24(Unit:19 Standard Panel:5)	
	Outdoor		60		105	
Ref.piping size	Liquid/Gas	ømm	9.52(3/8") / 15.88(5/8")			
Refrigerant line (one way) length		m	Max. 50		Max. 100	
Vertical height differences	Outdoor is higher/lower	m	Max.30 / Max.15			
Outdoor operating temperature range	Cooling	°C	-15~43*2			
	Heating		-20~20			
Panel			T-PSA-5AW-E, T-PSAE-5AW-E			
Air filter, Q'ty			Pocket plastic net x 1(Washable)			
Remote control (option)			wired:RC-EX3A, RC-E5, RCH-E3 wireless:RCN-T-5AW-E2			

The values are for simultaneous Multi operation.

R410A		Hyper Inverter			
Set model name		FDT100VSXPVH	FDT125VSXPVH	FDT140VSXPVG	FDT140VSXTVH
		Twin			Triple
Indoor unit		FDT50VH x 2	FDT60VH x 2	FDT71VG x 2	FDT50VH x 3
Outdoor unit		FDC100VSX	FDC125VSX	FDC140VSX	FDC140VSX
Power source		3 Phase 380-415V, 50Hz / 380V, 60Hz			
Nominal cooling capacity (Min~Max)	kW	10.0 (4.0 ~ 11.2)	12.5 (5.0 ~ 14.0)	14.0 (5.0 ~ 16.0)	14.0 (5.0 ~ 16.0)
Nominal heating capacity (Min~Max)	kW	11.2 (4.0 ~ 16.0)	14.0 (4.0 ~ 18.0)	16.0 (4.0 ~ 20.0)	16.0 (4.0 ~ 20.0)
Power consumption	Cooling/Heating kW	2.56 / 2.67	3.26 / 3.22	3.88 / 3.74	3.93 / 4.00
EER/COP	Cooling/Heating	3.91 / 4.19	3.83 / 4.35	3.61 / 4.28	3.56 / 4.00
Inrush current		5	5	5	5
Max. current	A	15	15	15	15
Sound power level*1	Indoor <sup>3</sup>	Cooling/Heating	55 / 56	58 / 59	62 / 62
	Outdoor	Cooling/Heating	70 / 70	70 / 70	72 / 72
Sound pressure level*1	Indoor <sup>3</sup>	Cooling (P-Hi/Hi/Me/Lo)	41 / 33 / 30 / 26	44 / 34 / 30 / 27	46 / 35 / 34 / 29
	Outdoor	Heating (P-Hi/Hi/Me/Lo)	42 / 33 / 28 / 20	44 / 34 / 30 / 23	46 / 35 / 34 / 29
Air flow	Indoor <sup>3</sup>	Cooling/Heating	48 / 50	48 / 50	49 / 52
	Outdoor	Cooling/Heating	20 / 16 / 13 / 10	26 / 17 / 14 / 11	28 / 18 / 15 / 12
Exterior dimensions	Indoor	HeightxWidthxDepth	Unit: 236 x 840 x 840 Panel: 35 x 950 x 950		
	Outdoor		1,300 x 970 x 370		
Net weight	Indoor		24(Unit:19 Standard Panel:5)		24(Unit:19 Standard Panel:5)
	Outdoor		60		105
Ref.piping size	Liquid/Gas	ømm	9.52(3/8") / 15.88(5/8")		
Refrigerant line (one way) length		m	Max.100		
Vertical height differences	Outdoor is higher/lower	m	Max.30 / Max.15		
Outdoor operating temperature range	Cooling	°C	-15~43*2		
	Heating		-20~20		
Panel			T-PSA-5AW-E, T-PSAE-5AW-E		
Air filter, Q'ty			Pocket plastic net x 1(Washable)		
Remote control (option)			wired:RC-EX3A, RC-E5, RCH-E3 wireless:RCN-T-5AW-E2		

## SPECIFICATIONS -FDT-

R410A		Micro Inverter		
Set model name		FDT100VNAV	FDT125VNAV	FDT140VNAV
Indoor unit		FDT100VG	FDT125VG	FDT140VG
Outdoor unit		FDC100VNA	FDC125VNA	FDC140VNA
Power source		1 Phase 220-240V, 50Hz / 220V, 60Hz		
Nominal cooling capacity (Min-Max)	kW	10.0 ( 4.0 ~ 11.2 )	12.5 ( 5.0 ~ 14.0 )	13.6 ( 5.0 ~ 14.5 )
Nominal heating capacity (Min-Max)	kW	11.2 ( 4.0 ~ 12.5 )	14.0 ( 4.0 ~ 16.0 )	15.5 ( 4.0 ~ 16.5 )
Power consumption	Cooling/Heating	2.73 / 2.64	4.05 / 3.74	4.84 / 4.43
EER/COP	Cooling/Heating	3.66 / 4.26	3.09 / 3.74	2.81 / 3.50
Inrush current		5	5	5
Max. current		24	24	24
Sound power level*1	Indoor	Cooling/Heating	63 / 63	64 / 64
	Outdoor	Cooling/Heating	70 / 70	73 / 73
Sound pressure level*1	Indoor	Cooling (P-Hi/Hi/Me/Lo)	48 / 39 / 37 / 31	49 / 41 / 39 / 32
		Heating (P-Hi/Hi/Me/Lo)	48 / 39 / 37 / 31	49 / 41 / 39 / 32
Air flow	Indoor	Cooling/Heating	54 / 56	55 / 57
		Cooling (P-Hi/Hi/Me/Lo)	37 / 26 / 23 / 17	38 / 28 / 25 / 18
		Heating (P-Hi/Hi/Me/Lo)	37 / 26 / 23 / 17	38 / 28 / 25 / 18
	Outdoor	Cooling/Heating	75 / 73	75 / 73
Exterior dimensions	Indoor	HeightxWidthxDepth	Unit: 298 x 840 x 840 Panel: 35 x 950 x 950	
	Outdoor		845 x 970 x 370	
Net weight	Indoor		30(Unit:25 Standard Panel:5)	
	Outdoor		80	
Ref.piping size	Liquid/Gas	ømm	9.52(3/8") / 15.88(5/8")	
Refrigerant line (one way) length		m	Max.50	
Vertical height differences	Outdoor is higher/lower	m	Max.50 / Max.15	
Outdoor operating temperature range	Cooling	°C	-15~50*2	
	Heating		-20~20	
Panel			T-PSA-5AW-E, T-PSAE-5AW-E	
Air filter, Q'ty			Pocket plastic net x 1(Washable)	
Remote control (option)			wired:RC-EX3A, RC-E5, RCH-E3 wireless:RCN-T-5AW-E2	

R410A		Micro Inverter		
Set model name		FDT100VSAV	FDT125VSAV	FDT140VSAV
Indoor unit		FDT100VG	FDT125VG	FDT140VG
Outdoor unit		FDC100VSA	FDC125VSA	FDC140VSA
Power source		3 Phase 380-415V, 50Hz / 380V, 60Hz		
Nominal cooling capacity (Min-Max)	kW	10.0 ( 4.0 ~ 11.2 )	12.5 ( 5.0 ~ 14.0 )	13.6 ( 5.0 ~ 14.5 )
Nominal heating capacity (Min-Max)	kW	11.2 ( 4.0 ~ 12.5 )	14.0 ( 4.0 ~ 16.0 )	15.5 ( 4.0 ~ 16.5 )
Power consumption	Cooling/Heating	2.73 / 2.63	4.05 / 3.74	4.84 / 4.43
EER/COP	Cooling/Heating	3.66 / 4.26	3.09 / 3.74	2.81 / 3.50
Inrush current		5	5	5
Max. current		15	15	15
Sound power level*1	Indoor	Cooling/Heating	63 / 63	64 / 64
	Outdoor	Cooling/Heating	70 / 70	73 / 73
Sound pressure level*1	Indoor	Cooling (P-Hi/Hi/Me/Lo)	48 / 39 / 37 / 31	49 / 41 / 39 / 32
		Heating (P-Hi/Hi/Me/Lo)	48 / 39 / 37 / 31	49 / 41 / 39 / 32
Air flow	Indoor	Cooling/Heating	54 / 56	55 / 57
		Cooling (P-Hi/Hi/Me/Lo)	37 / 26 / 23 / 17	38 / 28 / 25 / 18
		Heating (P-Hi/Hi/Me/Lo)	37 / 26 / 23 / 17	38 / 28 / 25 / 18
	Outdoor	Cooling/Heating	75 / 73	75 / 73
Exterior dimensions	Indoor	HeightxWidthxDepth	Unit: 298 x 840 x 840 Panel: 35 x 950 x 950	
	Outdoor		845 x 970 x 370	
Net weight	Indoor		30(Unit:25 Standard Panel:5)	
	Outdoor		82	
Ref.piping size	Liquid/Gas	ømm	9.52(3/8") / 15.88(5/8")	
Refrigerant line (one way) length		m	Max.50	
Vertical height differences	Outdoor is higher/lower	m	Max.50 / Max.15	
Outdoor operating temperature range	Cooling	°C	-15~50*2	
	Heating		-20~20	
Panel			T-PSA-5AW-E, T-PSAE-5AW-E	
Air filter, Q'ty			Pocket plastic net x 1(Washable)	
Remote control (option)			wired:RC-EX3A, RC-E5, RCH-E3 wireless:RCN-T-5AW-E2	

### NOTES:

The data are measured under the following conditions(ISO-T1).

Cooling:Indoor temp. of 27°CDB, 19°CWB, and outdoor temp. of 35°CDB. Heating:Indoor temp. of 20°CDB, and outdoor temp. of 7°CDB, 6°CWB.

\*1 : Indicates the value in an anechoic chamber. During operation these values are somewhat higher due to ambient conditions.

\*2 : If a cooling operation is conducted when the outdoor air temperature is -5°C or lower, the outdoor unit should be installed at a place where it is not influenced by natural wind. If wind blows, the low pressure will drop and compressor frequency will increase, this will cause the capacity to drop and may cause the unit to break down.

\*3 : The values are for one indoor unit operation. (Multi system only)

The values are for simultaneous Multi operation.

R410A		Micro Inverter			
Set model name		FDT100VNAPVH	FDT125VNAPVH	FDT140VNAPVG	FDT140VNATVH
		Twin		Triple	
Indoor unit		FDT50VH x 2	FDT60VH x 2	FDT71VG x 2	FDT50VH x 3
Outdoor unit		FDC100VNA	FDC125VNA	FDC140VNA	FDC140VNA
Power source		1 Phase 220-240V, 50Hz / 220V, 60Hz			
Nominal cooling capacity (Min~Max)	kW	10.0 ( 4.0 ~ 11.2 )	12.5 ( 5.0 ~ 14.0 )	13.6 ( 5.0 ~ 14.5 )	13.6 ( 5.0 ~ 14.5 )
Nominal heating capacity (Min~Max)	kW	11.2 ( 4.0 ~ 12.5 )	14.0 ( 4.0 ~ 16.0 )	15.5 ( 4.0 ~ 16.5 )	15.5 ( 4.0 ~ 16.5 )
Power consumption	Cooling/Heating	2.82 / 2.90	3.79 / 3.31	4.22 / 3.29	4.22 / 3.29
EER/COP	Cooling/Heating	3.55 / 3.86	3.30 / 4.23	3.22 / 4.71	3.22 / 4.71
Inrush current		5	5	5	5
Max. current		24	24	24	24
Sound power level*1	Indoor <sup>3</sup>	Cooling/Heating	55 / 56	58 / 59	62 / 62
	Outdoor	Cooling/Heating	70 / 70	71 / 71	73 / 73
Sound pressure level*1	Indoor <sup>3</sup>	Cooling (P-Hi/Hi/Me/Lo)	41 / 33 / 30 / 26	44 / 34 / 30 / 27	46 / 35 / 34 / 29
	Outdoor	Heating (P-Hi/Hi/Me/Lo)	42 / 33 / 28 / 20	44 / 34 / 30 / 23	46 / 35 / 34 / 29
Air flow	Indoor <sup>3</sup>	Cooling (P-Hi/Hi/Me/Lo)	22 / 16 / 13 / 10	26 / 17 / 14 / 11	28 / 18 / 15 / 12
	Outdoor	Heating (P-Hi/Hi/Me/Lo)	22 / 16 / 13 / 10	26 / 17 / 14 / 11	28 / 18 / 15 / 12
Exterior dimensions	Indoor	HeightxWidthxDepth	Unit: 236 x 840 x 840 Panel: 35 x 950 x 950		
	Outdoor		845 x 970 x 370		
Net weight	Indoor		24(Unit:19 Standard Panel:5)	26(Unit:21 Standard Panel:5)	24(Unit:19 Standard Panel:5)
	Outdoor		80		
Ref.piping size	Liquid/Gas		9.52(3/8") / 15.88(5/8")		
Refrigerant line (one way) length			Max.50		
Vertical height differences	Outdoor is higher/lower		Max.50 / Max.15		
Outdoor operating temperature range	Cooling		-15~50*2		
	Heating		-20~20		
Panel			T-PSA-5AW-E, T-PSAE-5AW-E		
Air filter, Q'ty			Pocket plastic net x 1(Washable)		
Remote control (option)			wired:RC-EX3A, RC-E5, RCH-E3 wireless:RCN-T-5AW-E2		

The values are for simultaneous Multi operation.

R410A		Micro Inverter		
Set model name		FDT100VSAPVH	FDT125VSAPVH	FDT140VSAPVG
		Twin		
Indoor unit		FDT50VH x 2	FDT60VH x 2	FDT71VG x 2
Outdoor unit		FDC100VSA	FDC125VSA	FDC140VSA
Power source		3 Phase 380-415V, 50Hz / 380V, 60Hz		
Nominal cooling capacity (Min~Max)	kW	10.0 ( 4.0 ~ 11.2 )	12.5 ( 5.0 ~ 14.0 )	13.6 ( 5.0 ~ 14.5 )
Nominal heating capacity (Min~Max)	kW	11.2 ( 4.0 ~ 12.5 )	14.0 ( 4.0 ~ 16.0 )	15.5 ( 4.0 ~ 16.5 )
Power consumption	Cooling/Heating	2.82 / 2.90	3.79 / 3.31	4.22 / 3.29
EER/COP	Cooling/Heating	3.55 / 3.86	3.30 / 4.23	3.22 / 4.71
Inrush current		5	5	5
Max. current		15	15	15
Sound power level*1	Indoor <sup>3</sup>	Cooling/Heating	55 / 56	58 / 59
	Outdoor	Cooling/Heating	70 / 70	71 / 71
Sound pressure level*1	Indoor <sup>3</sup>	Cooling (P-Hi/Hi/Me/Lo)	41 / 33 / 30 / 26	44 / 34 / 30 / 27
	Outdoor	Heating (P-Hi/Hi/Me/Lo)	42 / 33 / 28 / 20	44 / 34 / 30 / 23
Air flow	Indoor <sup>3</sup>	Cooling (P-Hi/Hi/Me/Lo)	22 / 16 / 13 / 10	26 / 17 / 14 / 11
	Outdoor	Heating (P-Hi/Hi/Me/Lo)	22 / 16 / 13 / 10	26 / 17 / 14 / 11
Exterior dimensions	Indoor	HeightxWidthxDepth	Unit: 236 x 840 x 840 Panel: 35 x 950 x 950	
	Outdoor		845 x 970 x 370	
Net weight	Indoor		24(Unit:19 Standard Panel:5)	26(Unit:21 Standard Panel:5)
	Outdoor		82	
Ref.piping size	Liquid/Gas		9.52(3/8") / 15.88(5/8")	
Refrigerant line (one way) length			Max.50	
Vertical height differences	Outdoor is higher/lower		Max.50 / Max.15	
Outdoor operating temperature range	Cooling		-15~50*2	
	Heating		-20~20	
Panel			T-PSA-5AW-E, T-PSAE-5AW-E	
Air filter, Q'ty			Pocket plastic net x 1(Washable)	
Remote control (option)			wired:RC-EX3A, RC-E5, RCH-E3 wireless:RCN-T-5AW-E2	



## SPECIFICATIONS -FDT-

The values are for simultaneous Multi operation.

R410A		Micro Inverter			
Set model name		FDT200VSAPVG	FDT250VSAPVG	FDT140VSATVH	
		Twin		Triple	
Indoor unit		FDT100VG x 2	FDT125VG x 2	FDT50VH x 3	
Outdoor unit		FDC200VSA	FDC250VSA	FDC140VSA	
Power source		3 Phase 380-415V, 50Hz / 380V, 60Hz			
Nominal cooling capacity (Min~Max)	kW	19.0 ( 5.2 ~ 22.4 )	24.0 ( 6.9 ~ 28.0 )	13.6 ( 5.0 ~ 14.5 )	
Nominal heating capacity (Min~Max)	kW	22.4 ( 3.3 ~ 25.0 )	27.0 ( 5.5 ~ 31.5 )	15.5 ( 4.0 ~ 16.5 )	
Power consumption	Cooling/Heating	6.25 / 6.02	8.36 / 7.15	4.22 / 3.29	
EER/COP	Cooling/Heating	3.04 / 3.72	2.87 / 3.78	3.22 / 4.71	
Inrush current		5	5	5	
Max. current		20	21	15	
Sound power level*1	Indoor <sup>3</sup>	Cooling/Heating	63 / 63	64 / 64	55 / 56
	Outdoor	Cooling/Heating	72 / 74	73 / 75	73 / 73
Sound pressure level*1	Indoor <sup>3</sup>	Cooling (P-Hi/Hi/Me/Lo)	48 / 39 / 37 / 31	49 / 41 / 39 / 32	41 / 33 / 30 / 26
	Outdoor	Heating (P-Hi/Hi/Me/Lo)	48 / 39 / 37 / 31	49 / 41 / 39 / 32	42 / 33 / 28 / 20
Air flow	Indoor <sup>3</sup>	Cooling/Heating	58 / 59	59 / 62	57 / 59
	Outdoor	Cooling (P-Hi/Hi/Me/Lo)	37 / 26 / 23 / 17	38 / 28 / 25 / 18	22 / 16 / 13 / 10
Exterior dimensions	Indoor	HeightsWidthxDepth	Unit: 298 x 840 x 840 Panel: 35 x 950 x 950		
	Outdoor		1,300 x 970 x 370	1,505 x 970 x 370	
Net weight	Indoor		30(Unit:25 Standard Panel:5)		
	Outdoor		115	143	
Ref.piping size	Liquid/Gas	ømm	9.52(3/8") / 22.22(7/8")	12.7(1/2") / 22.22(7/8")	
Refrigerant line (one way) length		m	Max.70		
Vertical height differences	Outdoor is higher/lower	m	Max.30 / Max.15		
Outdoor operating temperature range	Cooling	°C	-15~50*2		
	Heating		-20~20		
Panel			T-PSA-5AW-E, T-PSAE-5AW-E		
Air filter, Q'ty			Pocket plastic net x 1(Washable)		
Remote control (option)			wired:RC-EX3A, RC-E5, RCH-E3 wireless:RCN-T-5AW-E2		

The values are for simultaneous Multi operation.

R410A		Micro Inverter			
Set model name		FDT200VSATVG	FDT200VSADVH	FDT250VSADVH	
		Triple	Double Twin		
Indoor unit		FDT71VG x 3	FDT50VH x 4	FDT60VH x 4	
Outdoor unit		FDC200VSA	FDC200VSA	FDC250VSA	
Power source		3 Phase 380-415V, 50Hz / 380V, 60Hz			
Nominal cooling capacity (Min~Max)	kW	19.0 ( 5.2 ~ 22.4 )	19.0 ( 5.2 ~ 22.4 )	24.0 ( 6.9 ~ 28.0 )	
Nominal heating capacity (Min~Max)	kW	22.4 ( 3.3 ~ 25.0 )	22.4 ( 3.3 ~ 25.0 )	27.0 ( 5.5 ~ 31.5 )	
Power consumption	Cooling/Heating	6.01 / 5.76	6.26 / 6.15	7.43 / 6.83	
EER/COP	Cooling/Heating	3.16 / 3.89	3.04 / 3.64	3.23 / 3.95	
Inrush current		5	5	5	
Max. current		20	20	21	
Sound power level*1	Indoor <sup>3</sup>	Cooling/Heating	62 / 62	55 / 56	58 / 59
	Outdoor	Cooling/Heating	72 / 74	72 / 74	73 / 75
Sound pressure level*1	Indoor <sup>3</sup>	Cooling (P-Hi/Hi/Me/Lo)	46 / 35 / 34 / 29	41 / 33 / 30 / 26	44 / 34 / 30 / 27
	Outdoor	Heating (P-Hi/Hi/Me/Lo)	46 / 35 / 34 / 29	42 / 33 / 28 / 20	44 / 34 / 30 / 23
Air flow	Indoor <sup>3</sup>	Cooling/Heating	58 / 59	58 / 59	59 / 62
	Outdoor	Cooling (P-Hi/Hi/Me/Lo)	28 / 18 / 15 / 12	22 / 16 / 13 / 10	26 / 17 / 14 / 11
Exterior dimensions	Indoor	HeightsWidthxDepth	Unit: 236 x 840 x 840 Panel: 35 x 950 x 950		
	Outdoor		1,300 x 970 x 370	1,505 x 970 x 370	
Net weight	Indoor		26(Unit:21 Standard Panel:5)		
	Outdoor		115	143	
Ref.piping size	Liquid/Gas	ømm	9.52(3/8") / 22.22(7/8")		
Refrigerant line (one way) length		m	Max.70		
Vertical height differences	Outdoor is higher/lower	m	Max.30 / Max.15		
Outdoor operating temperature range	Cooling	°C	-15~50*2		
	Heating		-15~20		
Panel			T-PSA-5AW-E, T-PSAE-5AW-E		
Air filter, Q'ty			Pocket plastic net x 1(Washable)		
Remote control (option)			wired:RC-EX3A, RC-E5, RCH-E3 wireless:RCN-T-5AW-E2		

### NOTES:

The data are measured under the following conditions(ISO-T1).

Cooling:Indoor temp. of 27°CDB, 19°CWB, and outdoor temp. of 35°CDB. Heating:Indoor temp. of 20°CDB, and outdoor temp. of 7°CDB, 6°CWB.

\*1 : Indicates the value in an anechoic chamber. During operation these values are somewhat higher due to ambient conditions.

\*2 : If a cooling operation is conducted when the outdoor air temperature is -5°C or lower, the outdoor unit should be installed at a place where it is not influenced by natural wind. If wind blows, the low pressure will drop and compressor frequency will increase, this will cause the capacity to drop and may cause the unit to break down.

\*3 : The values are for one indoor unit operation. (Multi system only)

R410A		Standard Inverter				
Set model name		FDT71VNPVG	FDT90VNP1VG	FDT100VNP1VG		
Indoor unit		FDT71VG	FDT100VG	FDT100VG		
Outdoor unit		FDC71VNP	FDC90VNP1	FDC100VNP		
Power source		1 Phase 220-240V, 50Hz / 220V, 60Hz				
Nominal cooling capacity (Min~Max)		7.1 ( 1.4 ~ 7.1 )	9.0 ( 1.9 ~ 9.0 )	10.0 ( 2.8 ~ 11.2 )		
Nominal heating capacity (Min~Max)		7.1 ( 1.0 ~ 7.1 )	9.0 ( 1.5 ~ 9.0 )	11.2 ( 2.5 ~ 12.5 )		
Power consumption	Cooling/Heating	kW	2.31 / 1.73	2.67 / 2.19	2.76 / 2.84	
EER/COP	Cooling/Heating		3.07 / 4.10	3.37 / 4.11	3.62 / 3.94	
Inrush current		A	5	5	5	
Max. current			14.5	18.0	21.0	
Sound power level*1	Indoor	Cooling/Heating	62 / 62	63 / 63	63 / 63	
	Outdoor	Cooling/Heating	67 / 67	69 / 69	70 / 70	
Sound pressure level*1	Indoor	Cooling (P-Hi/Hi/Me/Lo)	46 / 35 / 34 / 29	48 / 39 / 37 / 31	48 / 39 / 37 / 31	
		Heating (P-Hi/Hi/Me/Lo)	46 / 35 / 34 / 29	48 / 39 / 37 / 31	48 / 39 / 37 / 31	
Air flow	Indoor	Cooling (P-Hi/Hi/Me/Lo)	28 / 18 / 15 / 12	37 / 26 / 23 / 17	37 / 26 / 23 / 17	
		Heating (P-Hi/Hi/Me/Lo)	28 / 18 / 15 / 12	37 / 26 / 23 / 17	37 / 26 / 23 / 17	
	Outdoor	Cooling/Heating	36 / 36	63 / 49.5	75 / 79	
Exterior dimensions	Indoor	HeightxWidthxDepth	Unit: 236 x 840 x 840 Panel: 35 x 950 x 950		Unit: 298 x 840 x 840 Panel: 35 x 950 x 950	
	Outdoor		640 x 800(+71) x 290	750 x 880(+88) x 340	845 x 970 x 370	
Net weight	Indoor		26(Unit:21 Standard Panel:5)		30(Unit:25 Standard Panel:5)	
	Outdoor		45	57	70	
Ref.piping size	Liquid/Gas	ømm	6.35(1/4") / 12.7(1/2")	6.35(1/4") / 15.88(5/8")	9.52(3/8") / 15.88(5/8")	
Refrigerant line (one way) length		m	Max.30			
Vertical height differences	Outdoor is higher/lower	m	Max.20 / Max.20			
Outdoor operating temperature range	Cooling	°C	-15~46*2			
	Heating		-15~20			
Panel			T-PSA-5AW-E, T-PSAE-5AW-E			
Air filter, Q'ty			Pocket Plastic net x1(Washable)			
Remote control (option)			wired:RC-EX3A, RC-E5, RCH-E3 wireless:RCN-T-5AW-E2			

# FDTC

## Indoor Unit Ceiling Cassette -4way Compact

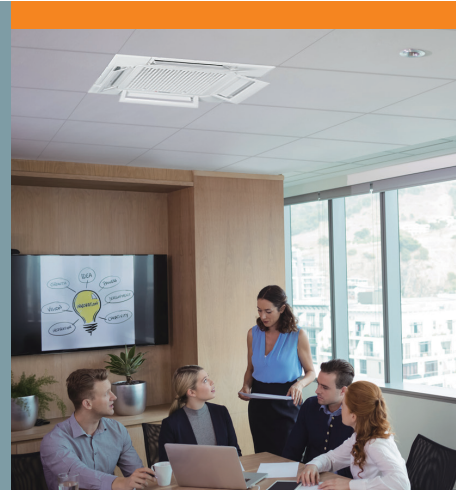
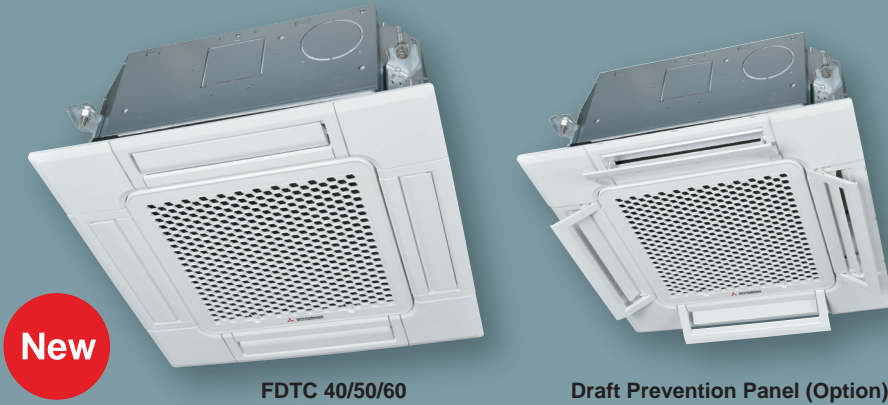

**New**

FDTC 40/50/60

Draft Prevention Panel (Option)



Energy Saving



Home Leave



Hi Power



Silent Operation



Flap Control



Favourite Setting



Remote control (option)

Wired



RC-EX3A



RC-E5



RCH-E3

Wireless



RCN-TC-5AW-E2

\*Not all functions available with all remote control options.

## European Design & Flat Panel

Integrated ceiling system design (600x600)

A grille designed with a unique structure and a clean white panel harmonize with interior. This design was invented by zweigrad GmbH & Co. KG in Germany.



Compact Design

A weight of only 14kg. Height of thin panel and main body is only 248mm allowing it to be a very easy installation.

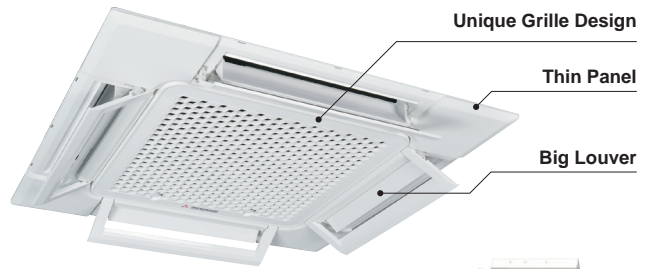

Taking OA (Outside Air) into inside

Fresh air can be taken in without option parts. When it is insufficient, existing option parts also can be used.

OA Spacer TC-OAS-E2(option)  
Joint Duct TC-OAD-E(option)

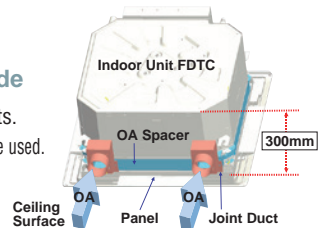

## Draft Prevention Panel (Option)

Draft Prevention Panel prevents cold/hot draft being blown directly on the user. It is possible to set Draft Prevention Panel for each air outlet.

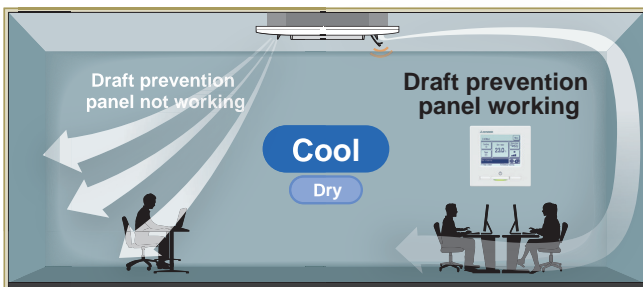

User can position Draft Prevention Panel panels by using the remote controller only (RC-EX3A, RCN-TC-5AW-E2).

## Motion Sensor (Option)

Motion sensor is equipped in the panel corner and detects the presence/absence and activity of humans in a room to improve the comfort and energy saving performance of the unit.



LB-TC-5W-E

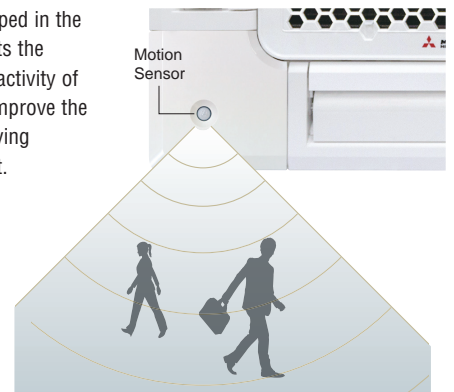



## Individual Flap Control System

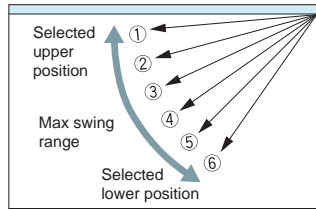

According to room temperature conditions, four directions of air flow can be controlled individually by following Flap control system. Individual flap control is available even after installation.

The flap can swing within the range of upper and lower flap position selected with wired remote control.

※The wireless remote control is not applicable to the Individual flap control system.

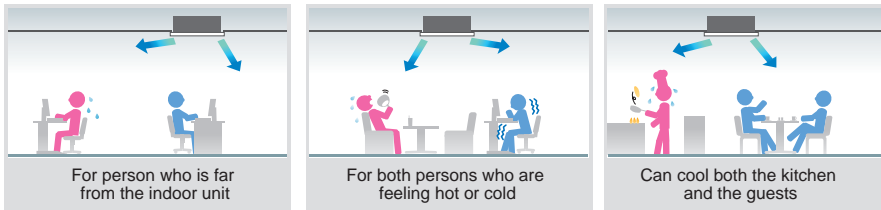

## Quieter Operation

Adopting new turbo fan and improving new heat exchanger enable to reduce noise.

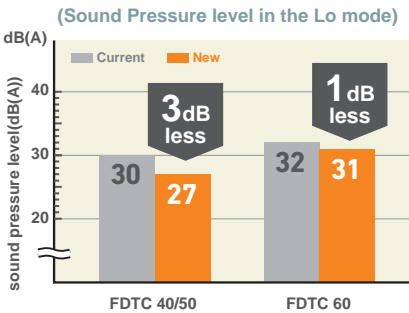

## 850mm Drain Pump

Drain can be discharged upward by 850mm from the ceiling surface close to the indoor unit. It allows a piping layout with a high degree of freedom depending on the installation location.

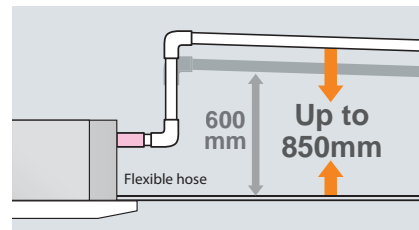

## Panel Select Pattern (Option)

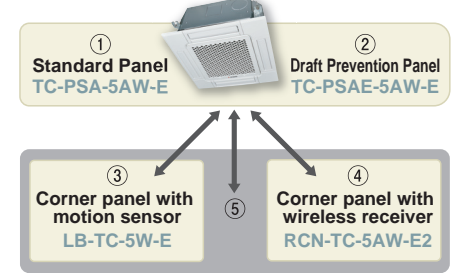

8 patterns of panel are available.

- ① Standard Panel only
- ①+③ Standard Panel with corner panel with motion sensor
- ①+④ Standard Panel with corner panel with wireless receiver
- ①+⑤ Standard Panel with corner panel with motion sensor & corner panel with wireless receiver
- ② Draft Prevention Panel only
- ②+③ Draft Prevention Panel with corner panel with motion sensor
- ②+④ Draft Prevention Panel with corner panel with wireless receiver
- ②+⑤ Draft Prevention Panel with corner panel with motion sensor & corner panel with wireless receiver

## OUTDOOR UNIT

SRC • FDC	Hyper Inverter		Hyper Inverter	
	40~60ZSX-W1	40~60ZSX-S	71VNX	100~140VN(S)X
model				
Chargeless	15m	15m	30m	
Height x Width x Depth (mm)	640 x 800(+71) x 290	640 x 800(+71) x 290	750 x 880(+88) x 340	1,300 x 970 x 370

FDC	Micro Inverter		
	100~140VN(S)A	200VSA	250VSA
model			
Chargeless	30m		
Height x Width x Depth (mm)	845 x 970 x 370	1,300 x 970 x 370	1,505 x 970 x 370

## DIMENSIONS (Unit:mm) - FDTC -

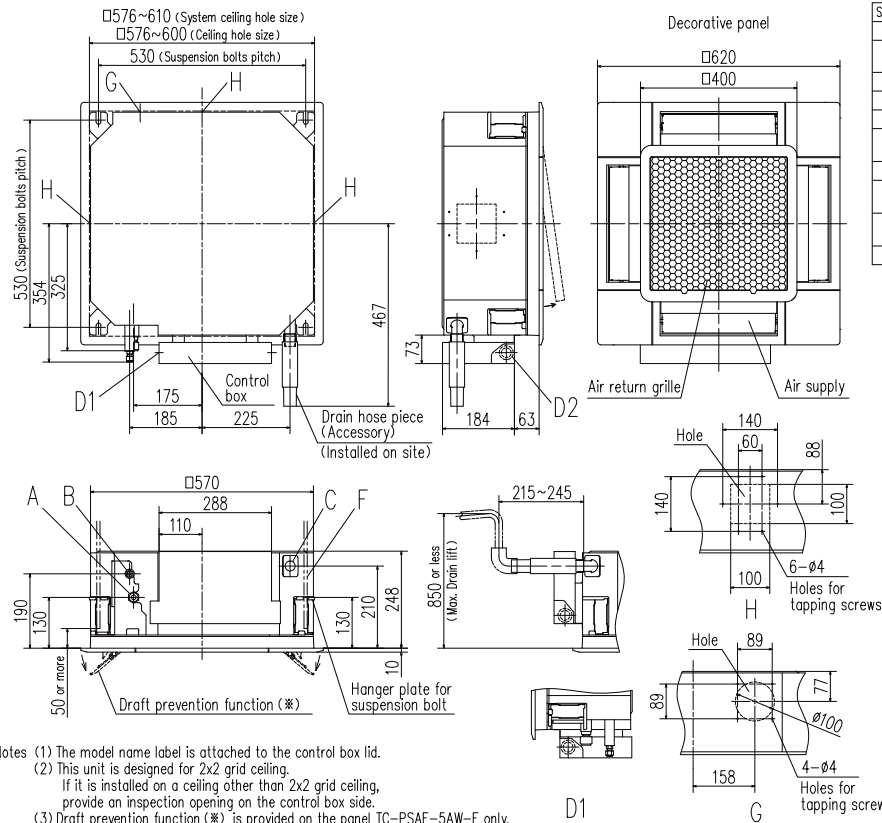

Symbol	Content	Model	
		25,35	40,50,60
A	Gas piping	ø9.52 (3/8") (Flare)	ø12.7 (1/2") (Flare)
B	Liquid piping	ø6.35 (1/4") (Flare)	
C	Drain piping	VP25 (O.D.32)	
D1	Power supply connection		
D2	Remote control code and signal wiring connection		
F	Suspension bolts	(M10 or M8)	
G	Outside air opening for ducting	(Knock out)	
H	Air outlet opening for ducting	ø125 (Knock out)	
J	Inspection opening	450X450	

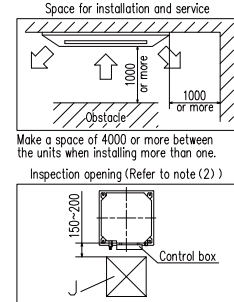

- Notes
- (1) The model name label is attached to the control box lid.
  - (2) This unit is designed for 2x2 grid ceiling. If it is installed on a ceiling other than 2x2 grid ceiling, provide an inspection opening on the control box side.
  - (3) Draft prevention function (\*) is provided on the panel TC-PSAE-5AW-E only.

## SPECIFICATIONS -FDTC-

R32			Hyper Inverter		
Set model name			FDTC40ZSXW1VH	FDTC50ZSXW1VH	FDTC60ZSXW1VH
Indoor unit			FDTC40VH	FDTC50VH	FDTC60VH
Outdoor unit			SRC40ZSX-W1	SRC50ZSX-W1	SRC60ZSX-W1
Power source			1 Phase 220-240V, 50Hz / 220V, 60Hz		
Nominal cooling capacity (Min-Max)		kW	4.0 (1.1 ~ 4.7)	5.0 (1.1 ~ 5.6)	5.6 (1.1 ~ 6.3)
Nominal heating capacity (Min-Max)		kW	4.5 (0.6 ~ 5.4)	5.4 (0.6 ~ 6.3)	6.7 (0.6 ~ 6.7)
Power consumption	Cooling/Heating	kW	0.98 / 1.13	1.40 / 1.53	1.73 / 2.14
EER/COP	Cooling/Heating		4.08 / 3.98	3.58 / 3.53	3.23 / 3.13
Inrush current		A	5	5	5
Max. current			15	15	15
Sound power level*1	Indoor	Cooling/Heating	59 / 59	59 / 59	60 / 60
	Outdoor	Cooling/Heating	63 / 62	63 / 62	65 / 65
Sound pressure level*1	Indoor	Cooling (P-Hi/Hi/Me/Lo)	44 / 40 / 35 / 27	44 / 40 / 35 / 27	46 / 42 / 38 / 31
		Heating (P-Hi/Hi/Me/Lo)	44 / 40 / 35 / 27	44 / 40 / 35 / 27	46 / 42 / 38 / 31
	Outdoor	Cooling/Heating	52 / 50	52 / 50	53 / 54
		Cooling/Heating	13 / 11 / 9 / 7	13 / 11 / 9 / 7	14 / 12 / 10 / 8
Air flow	Indoor	Cooling/Heating	13 / 11 / 9 / 7	13 / 11 / 9 / 7	14 / 12 / 10 / 8
	Outdoor	Cooling/Heating	39 / 33	39 / 33	41.5 / 39
Exterior dimensions	Indoor	HeightxWidthxDepth	Unit: 248 x 570 x 570 Panel: 10 x 620 x 620		
	Outdoor		640 x 800(+71) x 290		
Net weight	Indoor		16.5(Unit:14 Standard Panel:2.5)		
	Outdoor		45		
Ref.piping size	Liquid/Gas	ømm	6.35(1/4") / 12.7(1/2")		
Refrigerant line (one way) length		m	Max.30		
Vertical height differences	Outdoor is higher/lower	m	Max.20 / Max.20		
Outdoor operating temperature range	Cooling	°C	-15~46*2		
	Heating		-20~24		
Panel			TC-PSA-5AW-E, TC-PSAE-5AW-E		
Air filter, Q'ty			Pocket plastic net x 1(Washable)		
Remote control (option)			wired:RC-EX3A, RC-E5, RCH-E3 wireless:RCN-TC-5AW-E2		

### NOTES:

The data are measured under the following conditions(ISO-T1,H1).  
Cooling:Indoor temp. of 27°CDB, 19°CWB, and outdoor temp. of 35°CDB. Heating:Indoor temp. of 20°CDB, and outdoor temp. of 7°CDB, 6°CWB.  
\*1 : Indicates the value in an anechoic chamber. During operation these values are somewhat higher due to ambient conditions.  
\*2 : If a cooling operation is conducted when the outdoor air temperature is -5°C or lower, the outdoor unit should be installed at a place where it is not influenced by natural wind. If wind blows, the low pressure will drop and compressor frequency will increase, this will cause the capacity to drop and may cause the unit to break down.

R410A		Hyper Inverter			
Set model name		FDTFC40ZSXVH	FDTFC50ZSXVH	FDTFC60ZSXVH	
Indoor unit		FDTFC40VH	FDTFC50VH	FDTFC60VH	
Outdoor unit		SRC40ZSX-S	SRC50ZSX-S	SRC60ZSX-S	
Power source		1 Phase 220-240V, 50Hz / 220V, 60Hz			
Nominal cooling capacity (Min~Max)		4.0 ( 1.1 ~ 4.7 )	5.0 ( 1.1 ~ 5.6 )	5.6 ( 1.1 ~ 6.3 )	
Nominal heating capacity (Min~Max)		4.5 ( 0.6 ~ 5.4 )	5.4 ( 0.6 ~ 6.3 )	6.7 ( 0.6 ~ 6.7 )	
Power consumption	Cooling/Heating	0.98 / 1.13	1.43 / 1.53	1.76 / 2.14	
EER/COP	Cooling/Heating	4.08 / 3.98	3.50 / 3.53	3.18 / 3.13	
Inrush current		5	5	5	
Max. current		12	15	15	
Sound power level*1	Indoor	Cooling/Heating	59 / 59	59 / 59	60 / 60
	Outdoor	Cooling/Heating	63 / 63	63 / 63	65 / 64
Sound pressure level*1	Indoor	Cooling (P-Hi/Hi/Me/Lo)	44 / 40 / 35 / 27	44 / 40 / 35 / 27	46 / 42 / 38 / 31
		Heating (P-Hi/Hi/Me/Lo)	44 / 40 / 35 / 27	44 / 40 / 35 / 27	46 / 42 / 38 / 31
	Outdoor	Cooling/Heating	50 / 49	50 / 49	52 / 52
		Cooling (P-Hi/Hi/Me/Lo)	13 / 11 / 9 / 7	13 / 11 / 9 / 7	14 / 12 / 10 / 8
Air flow	Indoor	Heating (P-Hi/Hi/Me/Lo)	13 / 11 / 9 / 7	13 / 11 / 9 / 7	14 / 12 / 10 / 8
		Cooling/Heating	36 / 33	40 / 33	41.5 / 39
	Outdoor	Cooling/Heating			
Exterior dimensions	Indoor	HeightxWidthxDepth	Unit: 248 x 570 x 570 Panel: 10 x 620 x 620		
	Outdoor	HeightxWidthxDepth	640 x 800(+71) x 290		
Net weight	Indoor		16.5(Unit:14 Standard Panel:2.5)		
	Outdoor		45		
Ref.piping size	Liquid/Gas	ømm	6.35(1/4") / 12.7(1/2")		
Refrigerant line (one way) length		m	Max.30		
Vertical height differences	Outdoor is higher/lower	m	Max.20 / Max.20		
Outdoor operating temperature range	Cooling	°C	-15~46*2		
	Heating	°C	-20~24		
Panel			TC-PSA-5AW-E, TC-PSAE-5AW-E		
Air filter, Q'ty			Pocket plastic net x 1(Washable)		
Remote control (option)			wired:RC-EX3A, RC-E5, RCH-E3 wireless:RCN-TC-5AW-E2		

The values are for simultaneous Multi operation.

R410A		Hyper Inverter				
Set model name		FDTFC71VNXPVH	FDTFC100VNXPVH	FDTFC125VNXPVH	FDTFC140VNXTPVH	
		Twin		Triple		
Indoor unit		FDTFC40VH x 2	FDTFC50VH x 2	FDTFC60VH x 2	FDTFC50VH x 3	
Outdoor unit		FDC71VNX	FDC100VNX	FDC125VNX	FDC140VNX	
Power source		1 Phase 220-240V, 50Hz / 220V, 60Hz				
Nominal cooling capacity (Min~Max)		7.1 ( 3.2 ~ 8.0 )	10.0 ( 4.0 ~ 11.2 )	12.5 ( 5.0 ~ 14.0 )	14.0 ( 5.0 ~ 16.0 )	
Nominal heating capacity (Min~Max)		8.0 ( 3.6 ~ 9.0 )	11.2 ( 4.0 ~ 12.5 )	14.0 ( 4.0 ~ 17.0 )	16.0 ( 4.0 ~ 18.0 )	
Power consumption	Cooling/Heating	2.03 / 1.64	2.80 / 3.50	4.10 / 4.10	4.20 / 4.34	
EER/COP	Cooling/Heating	3.50 / 4.88	3.57 / 3.20	3.05 / 3.41	3.33 / 3.69	
Inrush current		5	5	5	5	
Max. current		17	24	24	26	
Sound power level*1	Indoor*3	Cooling/Heating	59 / 59	59 / 59	60 / 60	59 / 59
	Outdoor	Cooling/Heating	66 / 66	70 / 70	70 / 70	72 / 72
Sound pressure level*1	Indoor*3	Cooling (P-Hi/Hi/Me/Lo)	44 / 40 / 35 / 27	44 / 40 / 35 / 27	46 / 42 / 38 / 31	44 / 40 / 35 / 27
		Heating (P-Hi/Hi/Me/Lo)	44 / 40 / 35 / 27	44 / 40 / 35 / 27	46 / 42 / 38 / 31	44 / 40 / 35 / 27
	Outdoor	Cooling/Heating	51 / 48	48 / 50	48 / 50	49 / 52
		Cooling (P-Hi/Hi/Me/Lo)	13 / 11 / 9 / 7	13 / 11 / 9 / 7	14 / 12 / 10 / 8	13 / 11 / 9 / 7
Air flow	Indoor*3	Heating (P-Hi/Hi/Me/Lo)	13 / 11 / 9 / 7	13 / 11 / 9 / 7	14 / 12 / 10 / 8	13 / 11 / 9 / 7
		Cooling/Heating	60 / 50	100 / 100	100 / 100	100 / 100
	Outdoor	Cooling/Heating				
Exterior dimensions	Indoor	HeightxWidthxDepth	Unit: 248 x 570 x 570 Panel: 10 x 620 x 620			
	Outdoor	HeightxWidthxDepth	750 x 880(+88) x 340	1,300 x 970 x 370		
Net weight	Indoor		16.5(Unit:14 Standard Panel:2.5)			
	Outdoor		60	105		
Ref.piping size	Liquid/Gas	ømm	9.52(3/8") / 15.88(5/8")			
Refrigerant line (one way) length		m	Max.50	Max.100		
Vertical height differences	Outdoor is higher/lower	m	Max.30 / Max.15			
Outdoor operating temperature range	Cooling	°C	-15~43*2			
	Heating	°C	-20~20			
Panel			TC-PSA-5AW-E, TC-PSAE-5AW-E			
Air filter, Q'ty			Pocket plastic net x 1(Washable)			
Remote control (option)			wired:RC-EX3A, RC-E5, RCH-E3 wireless:RCN-TC-5AW-E2			

NOTES:

The data are measured under the following conditions(ISO-T1).  
Cooling:Indoor temp. of 27°CDB, 19°CWB, and outdoor temp. of 35°CDB. Heating:Indoor temp. of 20°CDB, and outdoor temp. of 7°CDB, 6°CWB.  
\*1 : Indicates the value in an anechoic chamber. During operation these values are somewhat higher due to ambient conditions.  
\*2 : If a cooling operation is conducted when the outdoor air temperature is -5°C or lower, the outdoor unit should be installed at a place where it is not influenced by natural wind. If wind blows, the low pressure will drop and compressor frequency will increase, this will cause the capacity to drop and may cause the unit to break down.  
\*3 : The values are for one indoor unit operation. (Multi system only)



## SPECIFICATIONS -FDTC-

The values are for simultaneous Multi operation.

R410A		Hyper Inverter		
Set model name		FDTC100VFXPVH	FDTC125VFXPVH	FDTC140VFXTVH
		Twin		Triple
Indoor unit		FDTC50VH x 2	FDTC60VH x 2	FDTC50VH x 3
Outdoor unit		FDC100VSX	FDC125VSX	FDC140VSX
Power source		3 Phase 380-415V, 50Hz / 380V, 60Hz		
Nominal cooling capacity (Min~Max)	kW	10.0 ( 4.0 ~ 11.2 )	12.5 ( 5.0 ~ 14.0 )	14.0 ( 5.0 ~ 16.0 )
Nominal heating capacity (Min~Max)	kW	11.2 ( 4.0 ~ 16.0 )	14.0 ( 4.0 ~ 18.0 )	16.0 ( 4.0 ~ 20.0 )
Power consumption	Cooling/Heating kW	2.80 / 3.50	4.10 / 4.10	4.20 / 4.34
EER/COP	Cooling/Heating	3.57 / 3.20	3.05 / 3.41	3.33 / 3.69
Inrush current		5	5	5
Max. current	A	15	15	15
Sound power level*1	Indoor <sup>3</sup> Cooling/Heating	59 / 59	60 / 60	59 / 59
	Outdoor Cooling/Heating	70 / 70	70 / 70	72 / 72
Sound pressure level*1	Indoor <sup>3</sup> Cooling (P-Hi/Hi/Me/Lo)	44 / 40 / 35 / 27	46 / 42 / 38 / 31	44 / 40 / 35 / 27
	Heating (P-Hi/Hi/Me/Lo)	44 / 40 / 35 / 27	46 / 42 / 38 / 31	44 / 40 / 35 / 27
Air flow	Outdoor Cooling/Heating	48 / 50	48 / 50	49 / 52
	Indoor <sup>3</sup> Cooling (P-Hi/Hi/Me/Lo)	13 / 11 / 9 / 7	14 / 12 / 10 / 8	13 / 11 / 9 / 7
Exterior dimensions	Indoor	Unit: 248 x 570 x 570 Panel: 10 x 620 x 620		
	Outdoor	1,300 x 970 x 370		
Net weight	Indoor	16.5(Unit:14 Standard Panel:2.5)		
	Outdoor	105		
Ref.piping size	Liquid/Gas	9.52(3/8") / 15.88(5/8")		
Refrigerant line (one way) length	m	Max.100		
Vertical height differences	Outdoor is higher/lower	Max.30 / Max.15		
Outdoor operating temperature range	Cooling	-15~43*2		
	Heating	-20~20		
Panel		TC-PSA-5AW-E, TC-PSAE-5AW-E		
Air filter, Q'ty		Pocket plastic net x 1(Washable)		
Remote control (option)		wired:RC-EX3A, RC-E5, RCH-E3 wireless:RCN-TC-5AW-E2		

The values are for simultaneous Multi operation.

R410A		Micro Inverter		
Set model name		FDTC100VNA PVH	FDTC125VNA PVH	FDTC140VNA TVH
		Twin		Triple
Indoor unit		FDTC50VH x 2	FDTC60VH x 2	FDTC50VH x 3
Outdoor unit		FDC100VNA	FDC125VNA	FDC140VNA
Power source		1 Phase 220-240V, 50Hz / 220V, 60Hz		
Nominal cooling capacity (Min~Max)	kW	10.0 ( 4.0 ~ 11.2 )	12.5 ( 5.0 ~ 14.0 )	13.6 ( 5.0 ~ 14.5 )
Nominal heating capacity (Min~Max)	kW	11.2 ( 4.0 ~ 12.5 )	14.0 ( 4.0 ~ 16.0 )	15.5 ( 4.0 ~ 16.5 )
Power consumption	Cooling/Heating kW	3.30 / 3.15	4.90 / 4.50	4.75 / 4.60
EER/COP	Cooling/Heating	3.03 / 3.56	2.55 / 3.11	2.86 / 3.37
Inrush current		5	5	5
Max. current	A	25	25	25
Sound power level*1	Indoor <sup>3</sup> Cooling/Heating	59 / 59	60 / 60	59 / 59
	Outdoor Cooling/Heating	70 / 70	71 / 71	73 / 73
Sound pressure level*1	Indoor <sup>3</sup> Cooling (P-Hi/Hi/Me/Lo)	44 / 40 / 35 / 27	46 / 42 / 38 / 31	44 / 40 / 35 / 27
	Heating (P-Hi/Hi/Me/Lo)	44 / 40 / 35 / 27	46 / 42 / 38 / 31	44 / 40 / 35 / 27
Air flow	Outdoor Cooling/Heating	54 / 56	55 / 57	57 / 59
	Indoor <sup>3</sup> Cooling (P-Hi/Hi/Me/Lo)	13 / 11 / 9 / 7	14 / 12 / 10 / 8	13 / 11 / 9 / 7
Exterior dimensions	Indoor	Unit: 248 x 570 x 570 Panel: 10 x 620 x 620		
	Outdoor	845 x 970 x 370		
Net weight	Indoor	16.5(Unit:14 Standard Panel:2.5)		
	Outdoor	80		
Ref.piping size	Liquid/Gas	9.52(3/8") / 15.88(5/8")		
Refrigerant line (one way) length	m	Max.50		
Vertical height differences	Outdoor is higher/lower	Max.50 / Max.15		
Outdoor operating temperature range	Cooling	-15~50*2		
	Heating	-20~20		
Panel		TC-PSA-5AW-E, TC-PSAE-5AW-E		
Air filter, Q'ty		Pocket plastic net x 1(Washable)		
Remote control (option)		wired:RC-EX3A, RC-E5, RCH-E3, wireless:RCN-TC-5AW-E2		

### NOTES:

The data are measured under the following conditions(ISO-T1).

Cooling:Indoor temp. of 27°CDB, 19°CWB, and outdoor temp. of 35°CDB. Heating:Indoor temp. of 20°CDB, and outdoor temp. of 7°CDB, 6°CWB.

\*1 : Indicates the value in an anechoic chamber. During operation these values are somewhat higher due to ambient conditions.

\*2 : If a cooling operation is conducted when the outdoor air temperature is -5°C or lower, the outdoor unit should be installed at a place where it is not influenced by natural wind. If wind blows, the low pressure will drop and compressor frequency will increase, this will cause the capacity to drop and may cause the unit to break down.

\*3 : The values are for one indoor unit operation. (Multi system only)

The values are for simultaneous Multi operation.

R410A		Micro Inverter					
Set model name		FDTC100VSAPVH	FDTC125VSAPVH	FDTC140VSATVH	FDTC200VSADVH	FDTC250VSADVH	
		Twin		Triple	Double Twin		
Indoor unit		FDTC50VH x 2	FDTC60VH x 2	FDTC50VH x 3	FDTC50VH x 4	FDTC60VH x 4	
Outdoor unit		FDC100VSA	FDC125VSA	FDC140VSA	FDC200VSA	FDC250VSA	
Power source		3 Phase 380-415V, 50Hz / 380V, 60Hz					
Nominal cooling capacity (Min~Max)	kW	10.0 ( 4.0 ~ 11.2 )	12.5 ( 5.0 ~ 14.0 )	13.6 ( 5.0 ~ 14.5 )	19.0 ( 5.2 ~ 22.4 )	24.0 ( 6.9 ~ 28.0 )	
Nominal heating capacity (Min~Max)	kW	11.2 ( 4.0 ~ 12.5 )	14.0 ( 4.0 ~ 16.0 )	15.5 ( 4.0 ~ 16.5 )	22.4 ( 3.3 ~ 25.0 )	27.0 ( 5.5 ~ 31.5 )	
Power consumption	Cooling/Heating	3.30 / 3.15	4.90 / 4.50	4.75 / 4.60	6.95 / 10.7	6.79 / 8.20	
EER/COP	Cooling/Heating	3.03 / 3.56	2.55 / 3.11	2.86 / 3.37	2.73 / 2.10	3.53 / 3.29	
Inrush current		5	5	5	5	5	
Max. current		15	15	15	20	21	
Sound power level*1	Indoor <sup>3</sup>	Cooling/Heating	59 / 59	60 / 60	59 / 59	59 / 59	
	Outdoor	Cooling/Heating	70 / 70	71 / 71	73 / 73	72 / 74	
Sound pressure level*1	Indoor <sup>3</sup>	Cooling (P-Hi/Hi/Me/Lo)	44 / 40 / 35 / 27	46 / 42 / 38 / 31	44 / 40 / 35 / 27	44 / 40 / 35 / 27	
	Outdoor	Heating (P-Hi/Hi/Me/Lo)	44 / 40 / 35 / 27	46 / 42 / 38 / 31	44 / 40 / 35 / 27	44 / 40 / 35 / 27	
Air flow	Indoor <sup>3</sup>	Cooling/Heating	54 / 56	55 / 57	57 / 59	58 / 59	
	Outdoor	Cooling/Heating	13 / 11 / 9 / 7	14 / 12 / 10 / 8	13 / 11 / 9 / 7	13 / 11 / 9 / 7	
Exterior dimensions	Indoor	HeightxWidthxDepth	13 / 11 / 9 / 7	14 / 12 / 10 / 8	13 / 11 / 9 / 7	13 / 11 / 9 / 7	
	Outdoor	HeightxWidthxDepth	13 / 11 / 9 / 7	14 / 12 / 10 / 8	13 / 11 / 9 / 7	13 / 11 / 9 / 7	
Net weight	Indoor		75 / 73	75 / 73	75 / 73	135 / 135	
	Outdoor		75 / 73	75 / 73	75 / 73	135 / 135	
Ref.piping size	Liquid/Gas		Unit: 248 x 570 x 570 Panel: 10 x 620 x 620				
Refrigerant line (one way) length			845 x 970 x 370		1,300 x 970 x 370	1,505 x 970 x 370	
Vertical height differences	Outdoor is higher/lower		16.5(Unit:14 Standard Panel:2.5)				
Outdoor operating temperature range	Cooling		82		115	143	
	Heating		9.52(3/8") / 15.88(5/8")		9.52(3/8") / 22.22(7/8")	12.7(1/2") / 22.22(7/8")	
Panel			Max.50			Max.70	
Air filter, Q'ty			Max.50 / Max.15			Max.30 / Max.15	
Remote control (option)			-15~50*2			-15~20	
			-20~20		-15~20		
			TC-PSA-5AW-E, TC-PSAE-5AW-E				
			Pocket plastic net x 1(Washable)				
			wired:RC-EX3A, RC-E5, RCH-E3 wireless:RCN-TC-5AW-E2				

# FDU

Indoor Unit

Duct Connected -High Static pressure-

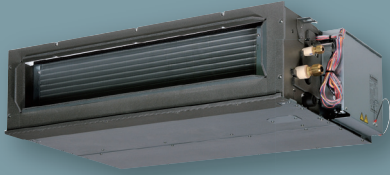

FDU 71/100/125/140

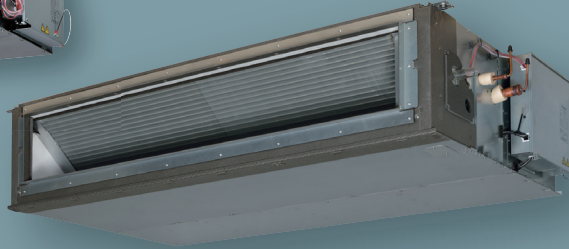

FDU 200/250

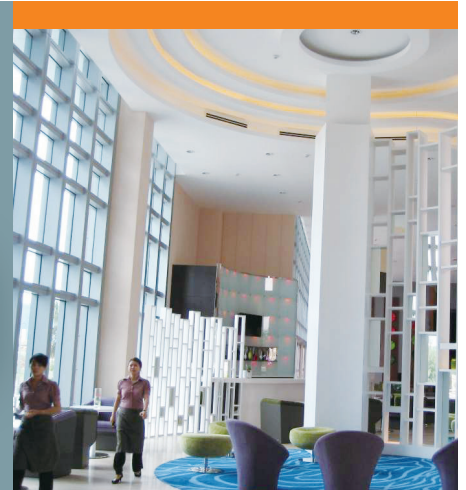

- Energy Saving
- Automatic Operation
- Silent Operation
- Hi Power
- Weekly/Sleep/Peak-Cut Timer
- Self-Diagnostics



Remote control (option)

Wired			Wireless	
RC-EX3A	RC-E5	RCH-E3	RCN-KIT4-E2	

\*Not all functions available with all remote control options.

## External Static Pressure (E.S.P.) Control

You can set External Static Pressure (E.S.P.) by method of manual setting on remote control. Indoor unit will control fan-speed to keep rated air flow volume at each fan speed setting. You can set required E.S.P. by wired remote control that calculated with the set air flow rate and pressure loss of the duct connected.

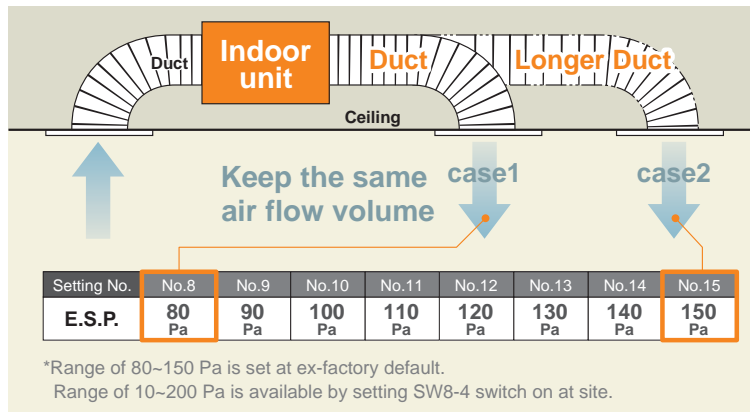

Expansion of external static pressure range

Previous  
10~130Pa

Current  
10~200Pa

### RC-E5

E.S.P. button

External Static Pressure (E.S.P.) can be set by E.S.P. button.



## Motion Sensor (Option)

Motion sensor is equipped in the ceiling plane or wall plane and detects the presence/absence and activity of humans in a room to improve the comfort and energy saving performance of the unit.



LB-KIT

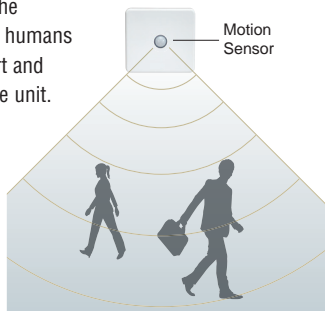

## High Efficiency

Energy efficiency is improved by use of DC fan motor & high efficient heat exchanger.

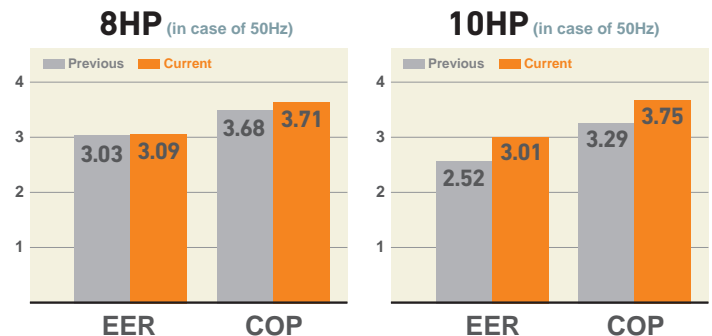

## Quieter Noise

Thanks to use of DC fan motor, quiet operation is achieved.

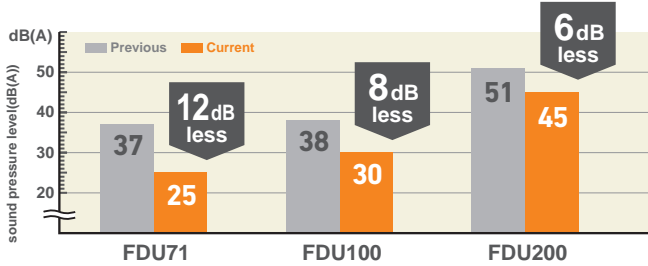

## Transparent Inspection Window

Dirt condition of the bottom of a drain pan can be checked through this transparent inspection window without removing drain pan.

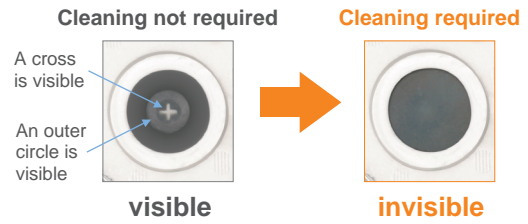

## Improvement of the Serviceability

Fan unit (impeller and motor) can be pulled out from the right side of the unit. Maintenance can be available from the right side or the bottom side.

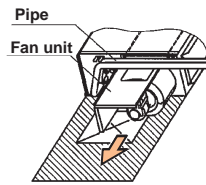

## Enhanced Installation Workability

600mm Drain Pump Pipe is mounted in FDU71/100/125/140. The indoor unit is completely hidden in the ceiling, so this is suitable for spaces with classy interior decoration.

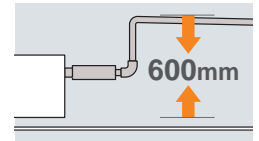



## Round Duct Adapter (Available for FDU71~140)



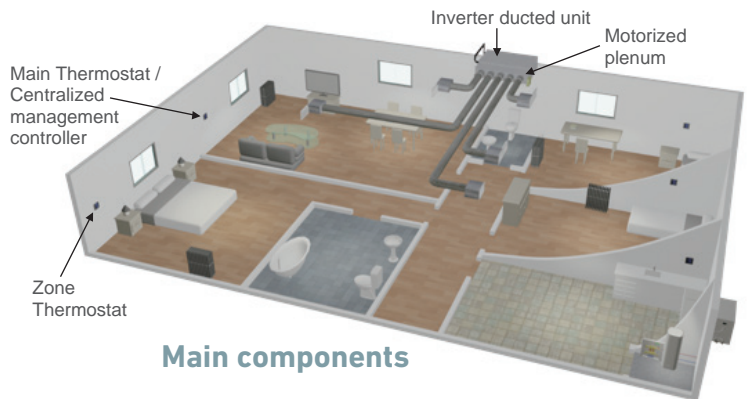
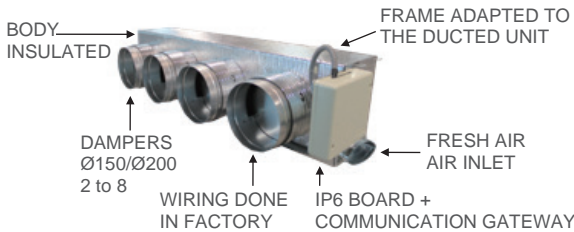



**AIRZONE** Company: AIRZONE  
URL: <http://www.airzone.es>

All-in-one solution: the whole zoning system in a plug&play device perfectly adapted to the indoor DX unit



## OUTDOOR UNIT

		Hyper Inverter	
FDC		71VNX	100~140VN(S)X
model			
Chargeless		30m	
Height x Width x Depth (mm)		750 x 880(+88) x 340	1,300 x 970 x 370

		Micro Inverter			Standard Inverter		
FDC		100~140VN(S)A	200VSA	250VSA	71VNP	90VNP1	100VNP
model							
Chargeless		30m			15m		
Height x Width x Depth (mm)		845 x 970 x 370	1,300 x 970 x 370	1,505 x 970 x 370	640 x 800(+71) x 290	750 x 880(+88) x 340	845 x 970 x 370





## SPECIFICATIONS -FDU-

R410A			Hyper Inverter				
Set model name			FDU71VNXVF1	FDU100VNXVF2	FDU125VNXVF	FDU140VNXVF	
Indoor unit			FDU71VF1	FDU100VF2	FDU125VF	FDU140VF	
Outdoor unit			FDC71VNX	FDC100VNX	FDC125VNX	FDC140VNX	
Power source			1 Phase 220-240V, 50Hz / 220V, 60Hz				
Nominal cooling capacity (Min~Max)			kW 7.1 (3.2 ~ 8.0)	10.0 (4.0 ~ 11.2)	12.5 (5.0 ~ 14.0)	14.0 (5.0 ~ 16.0)	
Nominal heating capacity (Min~Max)			kW 8.0 (3.6 ~ 9.0)	11.2 (4.0 ~ 12.5)	14.0 (4.0 ~ 17.0)	16.0 (4.0 ~ 18.0)	
Power consumption			Cooling/Heating kW 2.05 / 2.01	2.68 / 3.02	3.49 / 3.77	4.28 / 4.42	
EER/COP			Cooling/Heating 3.46 / 3.98	3.73 / 3.71	3.58 / 3.71	3.27 / 3.62	
Inrush current			A 5				
Max. current			A 17				
Sound power level*1	Indoor	Cooling/Heating	65 / 65	65 / 65	67 / 67	70 / 70	
	Outdoor	Cooling/Heating	66 / 66	70 / 70	70 / 70	72 / 72	
Sound pressure level*1	Indoor	Cooling (P-Hi/Hi/Me/Lo)	dB(A) 38 / 33 / 29 / 25		44 / 38 / 36 / 30	45 / 40 / 34 / 29	47 / 40 / 35 / 30
		Heating (P-Hi/Hi/Me/Lo)	38 / 33 / 29 / 25		44 / 38 / 36 / 30	45 / 40 / 34 / 29	47 / 40 / 35 / 30
Air flow	Indoor	Cooling (P-Hi/Hi/Me/Lo)	m³/min 24 / 19 / 15 / 10		36 / 28 / 25 / 19	39 / 32 / 26 / 20	48 / 35 / 28 / 22
		Heating (P-Hi/Hi/Me/Lo)	24 / 19 / 15 / 10		36 / 28 / 25 / 19	39 / 32 / 26 / 20	48 / 35 / 28 / 22
Air flow	Outdoor	Cooling/Heating	60 / 50		100 / 100	100 / 100	100 / 100
		External static pressure*2	Pa	Standard:35 Max:200		Standard:60 Max:200	
Exterior dimensions	Indoor	HeightxWidthxDepth	mm 280 x 950 x 635		280 x 1,370 x 740		
	Outdoor		750 x 880(+88) x 340		1,300 x 970 x 370		
Net weight	Indoor		kg 34		54		
	Outdoor		60		105		
Ref.piping size	Liquid/Gas	ømm	9.52(3/8") / 15.88(5/8")				
Refrigerant line (one way) length			m Max.50		Max.100		
Vertical height differences			Outdoor is higher/lower		m Max.30 / Max.15		
Outdoor operating temperature range	Cooling	°C	-15~43*3				
	Heating		-20~20				
Air filter			Procure locally				
Remote control (option)			wired:RC-EX3A, RC-E5, RCH-E3 wireless:RCN-KIT4-E2				

R410A			Hyper Inverter				
Set model name			FDU100VSXVF2	FDU125VSXVF	FDU140VSXVF		
Indoor unit			FDU100VF2	FDU125VF	FDU140VF		
Outdoor unit			FDC100VSX	FDC125VSX	FDC140VSX		
Power source			3 Phase 380-415V, 50Hz / 380V, 60Hz				
Nominal cooling capacity (Min~Max)			kW 10.0 (4.0 ~ 11.2)	12.5 (5.0 ~ 14.0)	14.0 (5.0 ~ 16.0)		
Nominal heating capacity (Min~Max)			kW 11.2 (4.0 ~ 16.0)	14.0 (4.0 ~ 18.0)	16.0 (4.0 ~ 20.0)		
Power consumption			Cooling/Heating kW 2.68 / 3.02	3.49 / 3.77	4.28 / 4.42		
EER/COP			Cooling/Heating 3.73 / 3.71	3.58 / 3.71	3.27 / 3.62		
Inrush current			A 5				
Max. current			A 16				
Sound power level*1	Indoor	Cooling/Heating	65 / 65		67 / 67		
	Outdoor	Cooling/Heating	70 / 70		70 / 70		
Sound pressure level*1	Indoor	Cooling (P-Hi/Hi/Me/Lo)	dB(A) 44 / 38 / 36 / 30		45 / 40 / 34 / 29		
		Heating (P-Hi/Hi/Me/Lo)	44 / 38 / 36 / 30		45 / 40 / 34 / 29		
Air flow	Indoor	Cooling (P-Hi/Hi/Me/Lo)	m³/min 36 / 28 / 25 / 19		39 / 32 / 26 / 20		
		Heating (P-Hi/Hi/Me/Lo)	36 / 28 / 25 / 19		39 / 32 / 26 / 20		
Air flow	Outdoor	Cooling/Heating	100 / 100		100 / 100		
		External static pressure*2	Pa	Standard:60 Max:200			
Exterior dimensions	Indoor	HeightxWidthxDepth	mm 280 x 950 x 635		280 x 1,370 x 740		
	Outdoor		750 x 880(+88) x 340		1,300 x 970 x 370		
Net weight	Indoor		kg 34		54		
	Outdoor		60		105		
Ref.piping size	Liquid/Gas	ømm	9.52(3/8") / 15.88(5/8")				
Refrigerant line (one way) length			m Max.50		Max.100		
Vertical height differences			Outdoor is higher/lower		m Max.30 / Max.15		
Outdoor operating temperature range	Cooling	°C	-15~43*3				
	Heating		-20~20				
Air filter			Procure locally				
Remote control (option)			wired:RC-EX3A, RC-E5, RCH-E3 wireless:RCN-KIT4-E2				

### NOTES:

The data are measured under the following conditions(ISO-T1).

Cooling:Indoor temp. of 27°CDB, 19°CWB, and outdoor temp. of 35°CDB. Heating:Indoor temp. of 20°CDB, and outdoor temp. of 7°CDB, 6°CWB.

\*1 : Indicates the value in an anechoic chamber. During operation these values are somewhat higher due to ambient conditions.

\*2 : External static pressure is changeable to be set by the remote control. MAX external static pressure is "High static pressure" setting. The values of sound pressure level become 5dB(A) higher at external static pressure of 200Pa.

\*3 : If a cooling operation is conducted when the outdoor air temperature is -5°C or lower, the outdoor unit should be installed at a place where it is not influenced by natural wind. If wind blows, the low pressure will drop and compressor frequency will increase, this will cause the capacity to drop and may cause the unit to break down.

## SPECIFICATIONS -FDU-

R410A			Micro Inverter			
Set model name			FDU100VNAVF2	FDU125VNAVF	FDU140VNAVF	
Indoor unit			FDU100VF2	FDU125VF	FDU140VF	
Outdoor unit			FDC100VNA	FDC125VNA	FDC140VNA	
Power source			1 Phase 220-240V, 50Hz / 220V, 60Hz			
Nominal cooling capacity (Min~Max)			kW 10.0 ( 4.0 ~ 11.2 )	12.5 ( 5.0 ~ 14.0 )	13.6 ( 5.0 ~ 14.5 )	
Nominal heating capacity (Min~Max)			kW 11.2 ( 4.0 ~ 12.5 )	14.0 ( 4.0 ~ 16.0 )	15.5 ( 4.0 ~ 16.5 )	
Power consumption			Cooling/Heating kW 2.84 / 2.78	4.36 / 3.69	4.93 / 4.21	
EER/COP			Cooling/Heating 3.52 / 4.03	2.87 / 3.79	2.76 / 3.68	
Inrush current			A 5	5	5	
Max. current			A 26	26	27	
Sound power level*1	Indoor	Cooling/Heating	65 / 65	67 / 67	70 / 70	
	Outdoor	Cooling/Heating	70 / 70	71 / 71	73 / 73	
Sound pressure level*1	Indoor	Cooling (P-Hi/Hi/Me/Lo)	dB(A) 44 / 38 / 36 / 30	45 / 40 / 34 / 29	47 / 40 / 35 / 30	
		Heating (P-Hi/Hi/Me/Lo)		45 / 40 / 34 / 29	47 / 40 / 35 / 30	
	Outdoor	Cooling/Heating		54 / 56	55 / 57	57 / 59
		Cooling (P-Hi/Hi/Me/Lo)		36 / 28 / 25 / 19	39 / 32 / 26 / 20	48 / 35 / 28 / 22
Air flow	Indoor	Heating (P-Hi/Hi/Me/Lo)	m³/min 36 / 28 / 25 / 19	39 / 32 / 26 / 20	48 / 35 / 28 / 22	
		Cooling/Heating		75 / 73	75 / 73	
	Outdoor	Cooling/Heating		75 / 73	75 / 73	
External static pressure*2			Pa	Standard:60 Max:200		
Exterior dimensions	Indoor	HeightxWidthxDepth	mm	280 x 1,370 x 740		
	Outdoor			845 x 970 x 370		
Net weight	Indoor		kg	54		
	Outdoor			80		
Ref.piping size	Liquid/Gas		ømm	9.52(3/8") / 15.88(5/8")		
Refrigerant line (one way) length			m	Max.50		
Vertical height differences			Outdoor is higher/lower	Max.50 / Max.15		
Outdoor operating temperature range	Cooling	°C	-15~50*3			
	Heating		-20~20			
Air filter			Procure locally			
Remote control (option)			wired:RC-EX3A, RC-E5, RCH-E3 wireless:RCN-KIT4-E2			

R410A			Micro Inverter		
Set model name			FDU100VSAVF2	FDU125VSAVF	FDU140VSAVF
Indoor unit			FDU100VF2	FDU125VF	FDU140VF
Outdoor unit			FDC100VSA	FDC125VSA	FDC140VSA
Power source			3 Phase 380-415V, 50Hz / 380V, 60Hz		
Nominal cooling capacity (Min~Max)			kW 10.0 ( 4.0 ~ 11.2 )	12.5 ( 5.0 ~ 14.0 )	13.6 ( 5.0 ~ 14.5 )
Nominal heating capacity (Min~Max)			kW 11.2 ( 4.0 ~ 12.5 )	14.0 ( 4.0 ~ 16.0 )	15.5 ( 4.0 ~ 16.5 )
Power consumption			Cooling/Heating kW 2.84 / 2.78	4.36 / 3.69	4.93 / 4.21
EER/COP			Cooling/Heating 3.52 / 4.03	2.87 / 3.79	2.76 / 3.68
Inrush current			A 5	5	5
Max. current			A 17	17	18
Sound power level*1	Indoor	Cooling/Heating	dB(A) 44 / 38 / 36 / 30	65 / 65	70 / 70
	Outdoor	Cooling/Heating		70 / 70	73 / 73
Sound pressure level*1	Indoor	Cooling (P-Hi/Hi/Me/Lo)		45 / 40 / 34 / 29	47 / 40 / 35 / 30
		Heating (P-Hi/Hi/Me/Lo)		45 / 40 / 34 / 29	47 / 40 / 35 / 30
Air flow	Outdoor	Cooling/Heating	m³/min 36 / 28 / 25 / 19	54 / 56	57 / 59
		Cooling (P-Hi/Hi/Me/Lo)		39 / 32 / 26 / 20	48 / 35 / 28 / 22
	Heating (P-Hi/Hi/Me/Lo)	39 / 32 / 26 / 20		48 / 35 / 28 / 22	
External static pressure*2			Pa	Standard:60 Max:200	
Exterior dimensions	Indoor	HeightxWidthxDepth	mm	280 x 1,370 x 740	
	Outdoor			845 x 970 x 370	
Net weight	Indoor		kg	54	
	Outdoor			82	
Ref.piping size	Liquid/Gas		ømm	9.52(3/8") / 15.88(5/8")	
Refrigerant line (one way) length			m	Max.50	
Vertical height differences			Outdoor is higher/lower	Max.50 / Max.15	
Outdoor operating temperature range	Cooling	°C	-15~50*3		
	Heating		-20~20		
Air filter			Procure locally		
Remote control (option)			wired:RC-EX3A, RC-E5, RCH-E3 wireless:RCN-KIT4-E2		

### NOTES:

The data are measured under the following conditions(ISO-T1).

Cooling:Indoor temp. of 27°CDB, 19°CWB, and outdoor temp. of 35°CDB. Heating:Indoor temp. of 20°CDB, and outdoor temp. of 7°CDB, 6°CWB.

\*1 : Indicates the value in an anechoic chamber. During operation these values are somewhat higher due to ambient conditions.

\*2 : External static pressure is changeable to be set by the remote control. MAX external static pressure is "High static pressure" setting. The values of sound pressure level become 5dB(A) higher at external static pressure of 200Pa.

\*3 : If a cooling operation is conducted when the outdoor air temperature is -5°C or lower, the outdoor unit should be installed at a place where it is not influenced by natural wind. If wind blows, the low pressure will drop and compressor frequency will increase, this will cause the capacity to drop and may cause the unit to break down.

R410A			Micro Inverter		
Set model name			FDU200VSAVG		FDU250VSAVG
Indoor unit			FDU200VG		FDU250VG
Outdoor unit			FDC200VSA		FDC250VSA
Power source			3 Phase 380-415V, 50Hz / 380V, 60Hz		
Nominal cooling capacity (Min~Max)			19.0 ( 5.2 ~ 22.4 )		24.0 ( 6.9 ~ 28.0 )
Nominal heating capacity (Min~Max)			22.4 ( 3.3 ~ 25.0 )		27.0 ( 5.5 ~ 31.5 )
Power consumption			Cooling/Heating		kW
			6.15 / 6.03		7.98 / 7.20
EER/COP			Cooling/Heating		
			3.09 / 3.71		3.01 / 3.75
Inrush current			A		
Max. current			5		5
Sound power level*1			25		27
Sound pressure level*1			75 / 75		75 / 75
			72 / 74		73 / 75
Air flow			dB(A)		
			52 / 50 / 47 / 45		52 / 50 / 47 / 45
			52 / 50 / 47 / 45		52 / 50 / 47 / 45
			58 / 59		59 / 62
			80 / 72 / 64 / 56		80 / 72 / 64 / 56
			80 / 72 / 64 / 56		80 / 72 / 64 / 56
			135 / 135		143 / 151
External static pressure*2			Pa		Standard:72 Max:200
Exterior dimensions			mm		379 x 1,600 x 893
			1,300 x 970 x 370		1,505 x 970 x 370
Net weight			kg		89
			115		143
Ref.piping size			Liquid/Gas		ømm
			9.52(3/8") / 25.4(1")		12.7(1/2") / 25.4(1")
Refrigerant line (one way) length			m		Max.70
Vertical height differences			Outdoor is higher/lower		Max.30 / Max.15
Outdoor operating temperature range			Cooling		-15~50*3
			Heating		-15~20
Air filter					Procure locally
Remote control (option)					wired:RC-EX3A, RC-E5, RCH-E3 wireless:RCN-KIT4-E2

R410A			Standard Inverter			
Set model name			FDU71VNPVF1		FDU90VNP1VF2	FDU100VNP1VF2
Indoor unit			FDU71VF1		FDU100VF2	FDU100VF2
Outdoor unit			FDC71VNP		FDC90VNP1	FDC100VNP
Power source			1 Phase 220-240V, 50Hz / 220V, 60Hz			
Nominal cooling capacity (Min~Max)			7.1 ( 1.4 ~ 7.1 )		9.0 ( 1.9 ~ 9.0 )	10.0 ( 2.8 ~ 11.2 )
Nominal heating capacity (Min~Max)			7.1 ( 1.0 ~ 7.1 )		9.0 ( 1.5 ~ 9.0 )	11.2 ( 2.5 ~ 12.5 )
Power consumption			Cooling/Heating		kW	
			2.60 / 1.89		2.69 / 2.25	3.00 / 2.93
EER/COP			Cooling/Heating			
			2.73. / 3.76		3.35 / 4.00	3.33 / 3.82
Inrush current			A			
Max. current			5		5	5
			14.5		18.0	22.0
Sound power level*1			65 / 65		65 / 65	65 / 65
			67 / 67		69 / 69	70 / 70
Sound pressure level*1			dB(A)			
			38 / 33 / 29 / 25		44 / 38 / 36 / 30	44 / 38 / 36 / 30
			38 / 33 / 29 / 25		44 / 38 / 36 / 30	44 / 38 / 36 / 30
			54 / 54		57 / 55	57 / 61
Air flow			m³/min			
			24 / 19 / 15 / 10		36 / 28 / 25 / 19	36 / 28 / 25 / 19
			24 / 19 / 15 / 10		36 / 28 / 25 / 19	36 / 28 / 25 / 19
			36 / 36		63 / 49.5	75 / 79
External static pressure*2			Pa		Standard:35 Max:200	Standard:60 Max:200
Exterior dimensions			mm		280 x 950 x 635	280 x 1,370 x 740
			640 x 800(+71) x 290		750 x 880(+88) x 340	845 x 970 x 370
Net weight			kg		34	54
			45		57	70
Ref.piping size			Liquid/Gas		ømm	
			6.35(1/4") / 12.7(1/2")		6.35(1/4") / 15.88(5/8")	9.52(3/8") / 15.88(5/8")
Refrigerant line (one way) length			m		Max.30	
Vertical height differences			Outdoor is higher/lower		Max.20 / Max.20	
Outdoor operating temperature range			Cooling		-15~46*3	
			Heating		-15~20	
Air filter					Procure locally	
Remote control (option)					wired:RC-EX3A, RC-E5, RCH-E3 wireless:RCN-KIT4-E2	



# FDUM

Indoor Unit  
**Duct Connected**  
**-Low/Middle Static pressure-**

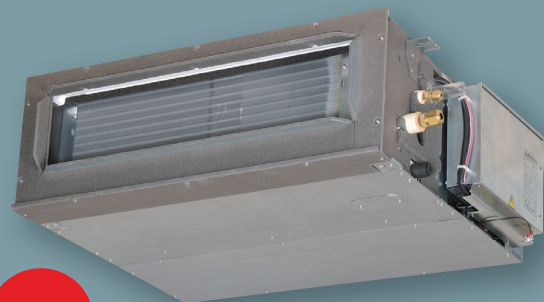

**New**

FDUM 40/50/60/71/100/125/140

Filter kit (option)



UM-FL1EF : for 40, 50  
 UM-FL2EF : for 60, 71  
 UM-FL3EF : for 100, 125, 140  
 external static pressure loss:5Pa



- Energy Saving
- Automatic Operation
- Silent Operation
- Hi Power
- Weekly/Sleep/Peak-Cut Timer
- Self-Diagnostics



Remote control (option)

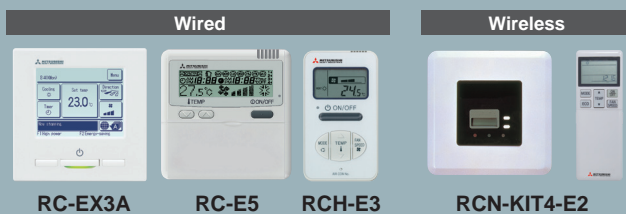

\*Not all functions available with all remote control options.

## Thin Design

The height of all FDUM models is only 280mm.

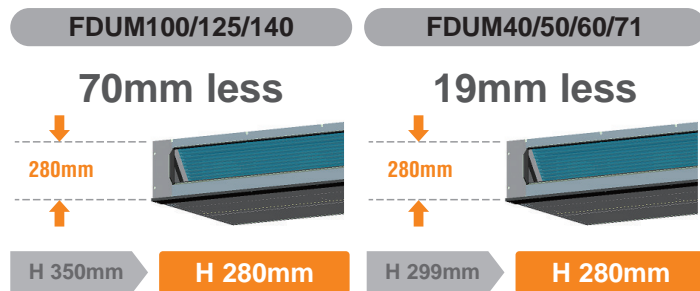

## Motion Sensor (Option)

Motion sensor is equipped in the ceiling plane or wall plane and detects the presence/absence and activity of humans in a room to improve the comfort and energy saving performance of the unit.



LB-KIT

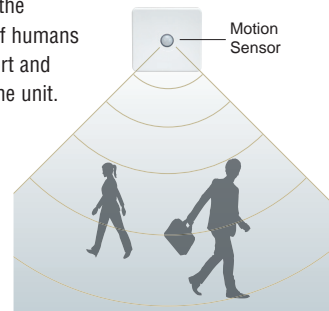

## Automatic External Static Pressure (E.S.P.) Control

Duct design was simplified. Using DC motor, the most optimum air flow volume can be achieved by this automatic control. Indoor unit will recognize external static pressure by itself automatically and keep rated air flow volume.

### RC-E5

E.S.P. button

External Static Pressure (E.S.P.) can be set by E.S.P. button.

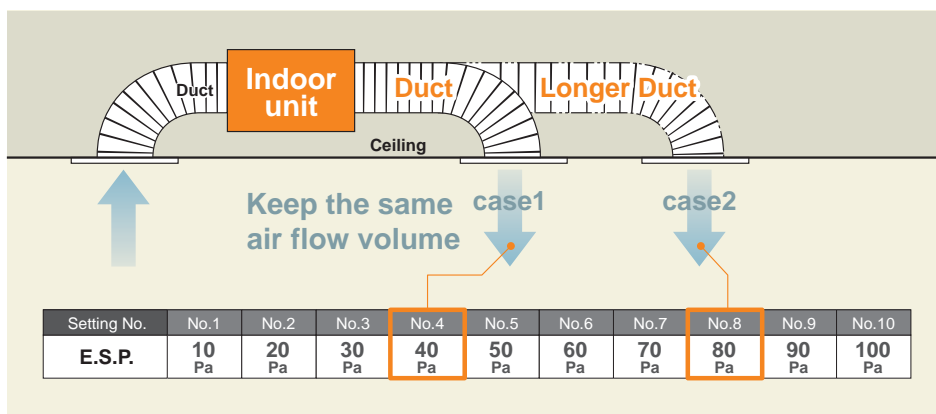

## Improvement of the Serviceability

Fan unit (impeller and motor) can be pulled out from the right side of the unit. Maintenance can be available from the right side or the bottom side.

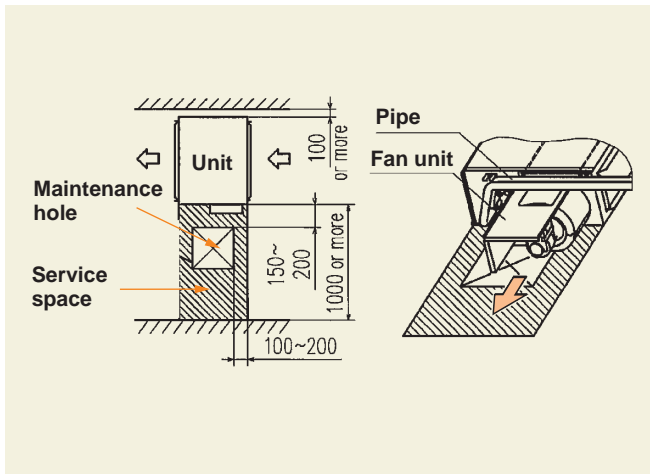

## Transparent Inspection Window

Dirt condition of the bottom of a drain pan can be checked through this transparent inspection window without removing drain pan.

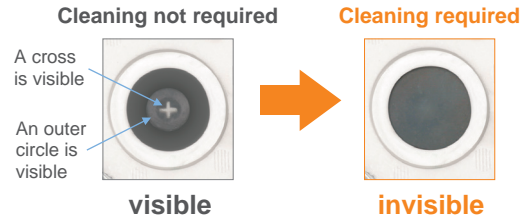

## Enhanced Installation Workability

600mm Drain Pump is mounted in all models. The indoor unit is completely hidden in the ceiling, so this is suitable for spaces with classy interior decoration.

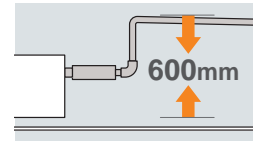

## Round Duct Adapter

**AIRZONE** Company: AIRZONE  
URL: <http://www.airzone.es>

All-in-one solution: the whole zoning system in a plug&play device perfectly adapted to the indoor DX unit

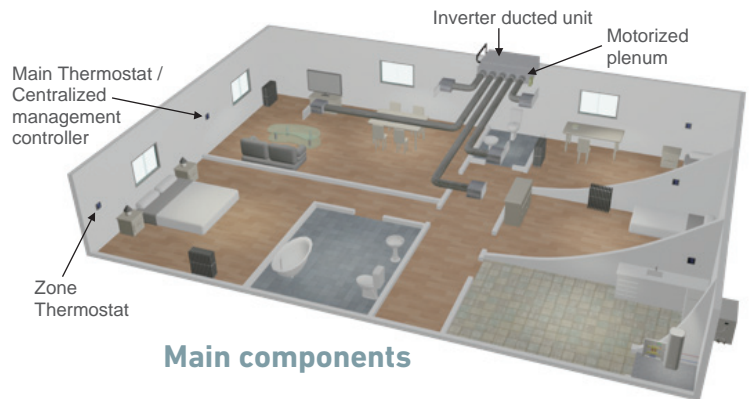
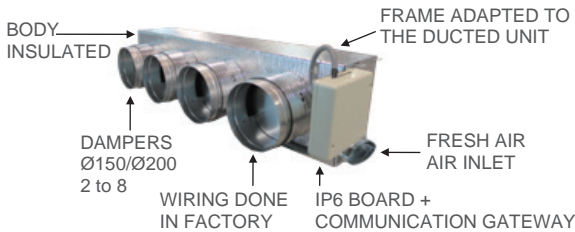

## OUTDOOR UNIT

	Hyper Inverter		Hyper Inverter	
SRC • FDC	40~60ZSX-W1	40~60ZSX-S	71VNX	100~140VN(S)X
model				
Chargeless	15m	15m	30m	
Height x Width x Depth (mm)	640 x 800(+71) x 290	640 x 800(+71) x 290	750 x 880(+88) x 340	1,300 x 970 x 370

	Micro Inverter			Standard Inverter		
FDC	100~140VN(S)A	200VSA	250VSA	71VNP	90VNP1	100VNP
model						
Chargeless	30m			15m		
Height x Width x Depth (mm)	845 x 970 x 370	1,300 x 970 x 370	1,505 x 970 x 370	640 x 800(+71) x 290	750 x 880(+88) x 340	845 x 970 x 370

# DIMENSIONS (Unit:mm) - FDUM -

## Models FDUM40VH, FDUM50VH

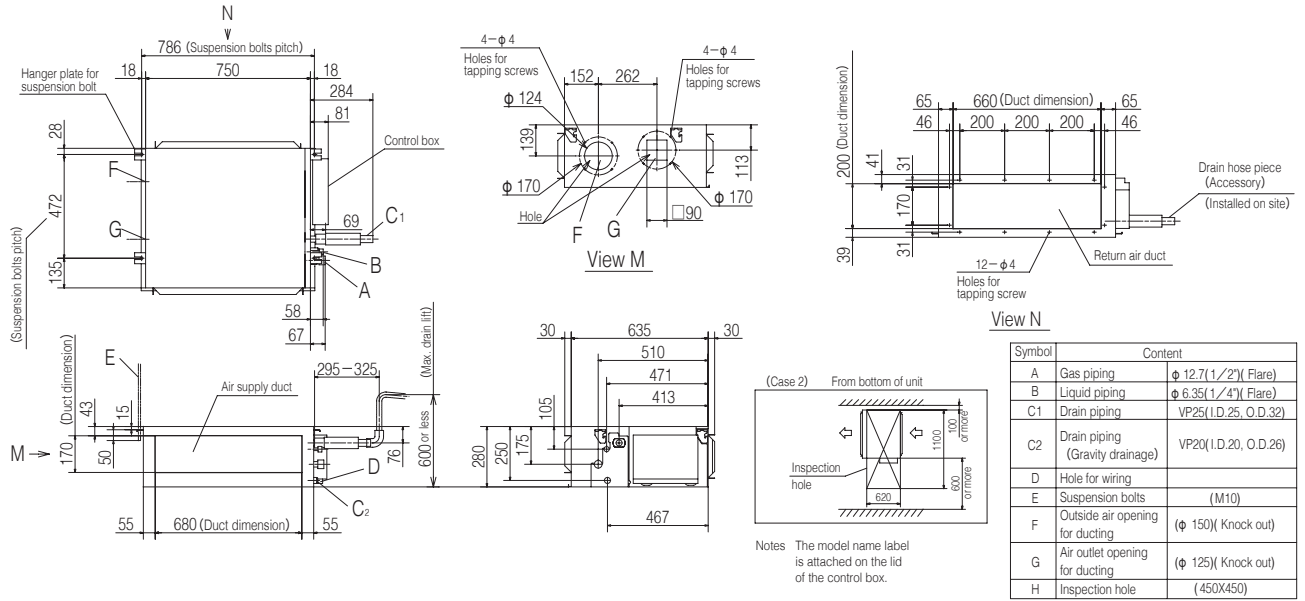

## Models FDUM60VH,71VF1

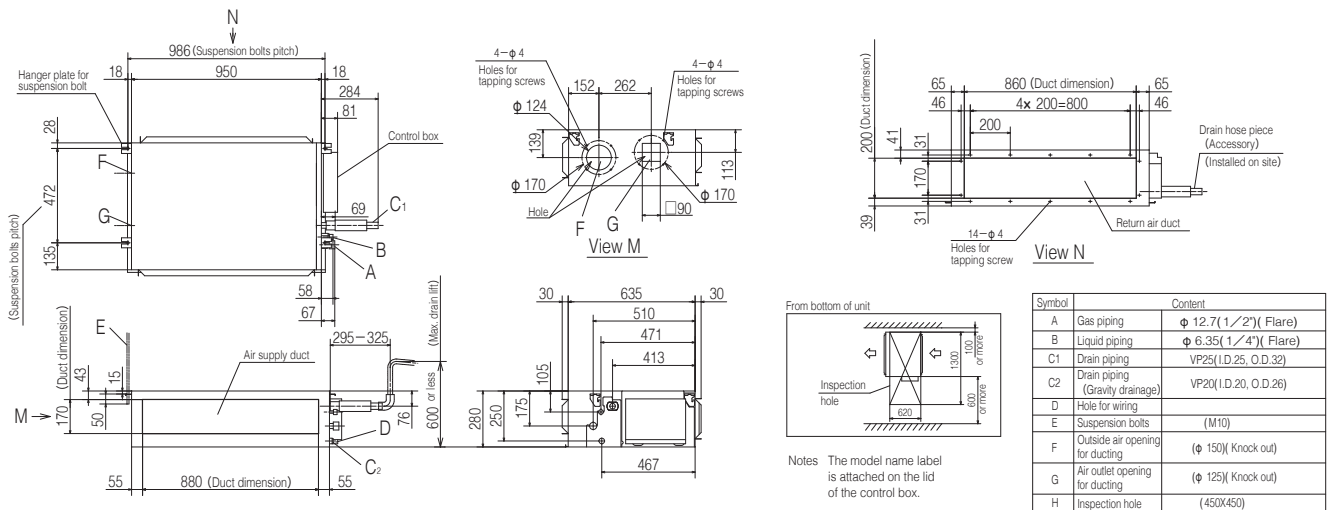

## Models FDUM100VF2,125VF,140VF

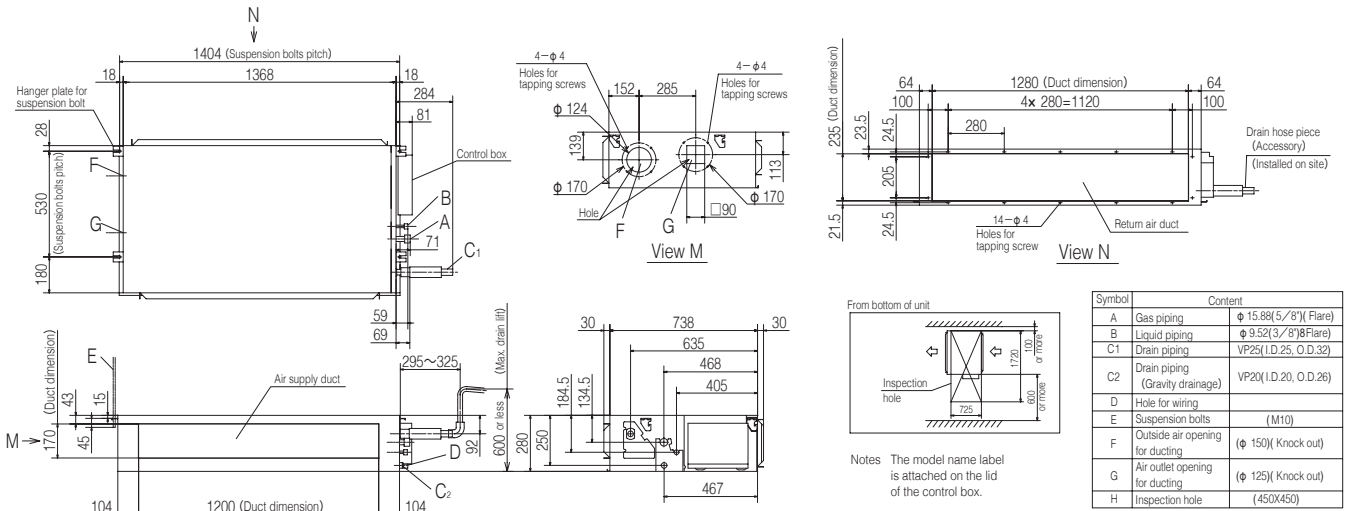

## SPECIFICATIONS - FDUM -

R32			Hyper Inverter		
Set model name			FDUM40ZSXW1VH	FDUM50ZSXW1VH	FDUM60ZSXW1VH
Indoor unit			FDUM40VH	FDUM50VH	FDUM60VH
Outdoor unit			SRC40ZSX-W1	SRC50ZSX-W1	SRC60ZSX-W1
Power source			1 Phase 220-240V, 50Hz / 220V, 60Hz		
Nominal cooling capacity (Min~Max)		kW	4.0 ( 1.1 ~ 4.7 )	5.0 ( 1.1 ~ 5.6 )	5.6 ( 1.1 ~ 6.3 )
Nominal heating capacity (Min~Max)		kW	4.5 ( 0.6 ~ 5.4 )	5.4 ( 0.6 ~ 6.3 )	6.7 ( 0.6 ~ 7.1 )
Power consumption	Cooling/Heating	kW	1.10 / 1.10	1.51 / 1.59	1.54 / 1.75
EER/COP	Cooling/Heating		3.62 / 4.09	3.31 / 3.39	3.64 / 3.83
Inrush current		A	5	5	5
Max. current			15	15	15
Sound power level*1	Indoor	Cooling/Heating	60 / 60	60 / 60	60 / 60
	Outdoor	Cooling/Heating	63 / 62	63 / 62	65 / 65
Sound pressure level*1	Indoor	Cooling (P-Hi/Hi/Me/Lo)	37 / 32 / 29 / 26	37 / 32 / 29 / 26	36 / 31 / 28 / 25
		Heating (P-Hi/Hi/Me/Lo)	37 / 32 / 29 / 26	37 / 32 / 29 / 26	36 / 31 / 28 / 25
	Outdoor	Cooling/Heating	52 / 50	52 / 50	53 / 54
Air flow	Indoor	Cooling (P-Hi/Hi/Me/Lo)	13 / 10 / 9 / 8	13 / 10 / 9 / 8	20 / 15 / 13 / 10
		Heating (P-Hi/Hi/Me/Lo)	13 / 10 / 9 / 8	13 / 10 / 9 / 8	20 / 15 / 13 / 10
	Outdoor	Cooling/Heating	39 / 33	39 / 33	41.5 / 39
External static pressure*2		Pa	Standard:35 Max:100		
Exterior dimensions	Indoor	HeightxWidthxDepth	280 x 750 x 635		280 x 950 x 635
	Outdoor		640 x 800(+71) x 290		
Net weight	Indoor		29		34
	Outdoor		45		
Ref.piping size	Liquid/Gas	ømm	6.35(1/4") / 12.7(1/2")		
Refrigerant line (one way) length		m	Max.30		
Vertical height differences		Outdoor is higher/lower	Max.20 / Max.20		
Outdoor operating temperature range	Cooling	°C	-15~46*3		
	Heating		-20~24		
Air filter (option)			Filter kit : UM-FL1EF		Filter kit : UM-FL2EF
Remote control (option)			wired:RC-EX3A, RC-E5, RCH-E3 wireless:RCN-KIT4-E2		

### NOTES:

The data are measured under the following conditions(ISO-T1,H1).

Cooling:Indoor temp. of 27°CDB, 19°CWB, and outdoor temp. of 35°CDB. Heating:Indoor temp. of 20°CDB, and outdoor temp. of 7°CDB, 6°CWB.

\*1 : Indicates the value in an anechoic chamber. During operation these values are somewhat higher due to ambient conditions.

\*2 : External static pressure is changeable to be set by the remote control. MAX external static pressure is "High static pressure" setting. The values of sound pressure level become 5dB(A) higher at external static pressure of 100Pa.

\*3 : If a cooling operation is conducted when the outdoor air temperature is -5°C or lower, the outdoor unit should be installed at a place where it is not influenced by natural wind. If wind blows, the low pressure will drop and compressor frequency will increase, this will cause the capacity to drop and may cause the unit to break down.

R410A			Hyper Inverter		
Set model name			FDUM40ZSXVH	FDUM50ZSXVH	FDUM60ZSXVH
Indoor unit			FDUM40VH	FDUM50VH	FDUM60VH
Outdoor unit			SRC40ZSX-S	SRC50ZSX-S	SRC60ZSX-S
Power source			1 Phase 220-240V, 50Hz / 220V, 60Hz		
Nominal cooling capacity (Min~Max)		kW	4.0 ( 1.1 ~ 4.7 )	5.0 ( 1.1 ~ 5.6 )	5.6 ( 1.1 ~ 6.3 )
Nominal heating capacity (Min~Max)		kW	4.5 ( 0.6 ~ 5.4 )	5.4 ( 0.6 ~ 6.3 )	6.7 ( 0.6 ~ 7.1 )
Power consumption	Cooling/Heating	kW	0.952 / 1.07	1.38 / 1.45	1.54 / 1.75
EER/COP	Cooling/Heating		4.20 / 4.21	3.62 / 3.72	3.64 / 3.83
Inrush current		A	5	5	5
Max. current			12	15	15
Sound power level*1	Indoor	Cooling/Heating	60 / 60	60 / 60	60 / 60
	Outdoor	Cooling/Heating	63 / 63	63 / 63	65 / 64
Sound pressure level*1	Indoor	Cooling (P-Hi/Hi/Me/Lo)	37 / 32 / 29 / 26	37 / 32 / 29 / 26	36 / 31 / 28 / 25
		Heating (P-Hi/Hi/Me/Lo)	37 / 32 / 29 / 26	37 / 32 / 29 / 26	36 / 31 / 28 / 25
	Outdoor	Cooling/Heating	50 / 49	50 / 49	52 / 52
Air flow	Indoor	Cooling (P-Hi/Hi/Me/Lo)	13 / 10 / 9 / 8	13 / 10 / 9 / 8	20 / 15 / 13 / 10
		Heating (P-Hi/Hi/Me/Lo)	13 / 10 / 9 / 8	13 / 10 / 9 / 8	20 / 15 / 13 / 10
	Outdoor	Cooling/Heating	36 / 33	40 / 33	41.5 / 39
External static pressure*2		Pa	Standard:35 Max:100		
Exterior dimensions	Indoor	HeightxWidthxDepth	280 x 750 x 635		280 x 950 x 635
	Outdoor		640 x 800(+71) x 290		
Net weight	Indoor		29		34
	Outdoor		45		
Ref.piping size	Liquid/Gas	ømm	6.35(1/4") / 12.7(1/2")		
Refrigerant line (one way) length		m	Max.30		
Vertical height differences		Outdoor is higher/lower	Max.20 / Max.20		
Outdoor operating temperature range	Cooling	°C	-15~46*3		
	Heating		-20~24		
Air filter (option)			Filter kit : UM-FL1EF		Filter kit : UM-FL2EF
Remote control (option)			wired:RC-EX3A, RC-E5, RCH-E3 wireless:RCN-KIT4-E2		

### NOTES:

The data are measured under the following conditions(ISO-T1).

Cooling:Indoor temp. of 27°CDB, 19°CWB, and outdoor temp. of 35°CDB. Heating:Indoor temp. of 20°CDB, and outdoor temp. of 7°CDB, 6°CWB.

\*1 : Indicates the value in an anechoic chamber. During operation these values are somewhat higher due to ambient conditions.

\*2 : External static pressure is changeable to be set by the remote control. MAX external static pressure is "High static pressure" setting. The values of sound pressure level become 5dB(A) higher at external static pressure of 100Pa.

\*3 : If a cooling operation is conducted when the outdoor air temperature is -5°C or lower, the outdoor unit should be installed at a place where it is not influenced by natural wind. If wind blows, the low pressure will drop and compressor frequency will increase, this will cause the capacity to drop and may cause the unit to break down.



## SPECIFICATIONS - FDUM -

R410A		Hyper Inverter			
Set model name		FDUM71VNXVF1	FDUM100VNXVF2	FDUM125VNXVF	FDUM140VNXV
Indoor unit		FDUM71VF1	FDUM100VF2	FDUM125VF	FDUM140VF
Outdoor unit		FDC71VNX	FDC100VNX	FDC125VNX	FDC140VNX
Power source		1 Phase 220-240V, 50Hz / 220V, 60Hz			
Nominal cooling capacity (Min~Max)		kW 7.1 (3.2 ~ 8.0)	10.0 (4.0 ~ 11.2)	12.5 (5.0 ~ 14.0)	14.0 (5.0 ~ 16.0)
Nominal heating capacity (Min~Max)		kW 8.0 (3.6 ~ 9.0)	11.2 (4.0 ~ 12.5)	14.0 (4.0 ~ 17.0)	16.0 (4.0 ~ 18.0)
Power consumption	Cooling/Heating	kW 2.03 / 1.99	2.68 / 3.02	3.49 / 3.77	4.28 / 4.42
EER/COP	Cooling/Heating	3.50 / 4.02	3.73 / 3.71	3.58 / 3.71	3.27 / 3.62
Inrush current		A 5	5	5	5
Max. current		17	24	26	26
Sound power level*1	Indoor	Cooling/Heating	65 / 65	65 / 65	67 / 67
	Outdoor	Cooling/Heating	66 / 66	70 / 70	70 / 70
Sound pressure level*1	Indoor	Cooling (P-Hi/Hi/Me/Lo)	dB(A) 38 / 33 / 29 / 25	44 / 38 / 36 / 30	45 / 40 / 34 / 29
		Heating (P-Hi/Hi/Me/Lo)	38 / 33 / 29 / 25	44 / 38 / 36 / 30	45 / 40 / 34 / 29
	Outdoor	Cooling/Heating	51 / 48	48 / 50	48 / 50
			24 / 19 / 15 / 10	36 / 28 / 25 / 19	39 / 32 / 26 / 20
Air flow	Indoor	Cooling (P-Hi/Hi/Me/Lo)	m <sup>3</sup> /min 24 / 19 / 15 / 10	36 / 28 / 25 / 19	39 / 32 / 26 / 20
		Heating (P-Hi/Hi/Me/Lo)	24 / 19 / 15 / 10	36 / 28 / 25 / 19	39 / 32 / 26 / 20
	Outdoor	Cooling/Heating	60 / 50	100 / 100	100 / 100
External static pressure*2		Pa Standard:35 Max:100	Standard:60 Max:100		
Exterior dimensions	Indoor	HeightxWidthxDepth	mm 280 x 950 x 635	280 x 1,370 x 740	
	Outdoor		750 x 880(+88) x 340	1,300 x 970 x 370	
Net weight	Indoor		kg 34	54	
	Outdoor		60	105	
Ref.piping size	Liquid/Gas	ømm	9.52(3/8") / 15.88(5/8")		
Refrigerant line (one way) length		m	Max.50	Max.100	
Vertical height differences		Outdoor is higher/lower	m Max.30 / Max.15		
Outdoor operating temperature range	Cooling	°C	-15~43*3		
	Heating		-20~20		
Air filter (option)			Filter kit : UM-FL2EF	Filter kit : UM-FL3EF	
Remote control (option)			wired:RC-EX3A, RC-E5, RCH-E3 wireless:RCN-KIT4-E2		

R410A		Hyper Inverter			
Set model name		FDUM100VSXVF2	FDUM125VSXVF	FDUM140VSXVF	
Indoor unit		FDUM100VF2	FDUM125VF	FDUM140VF	
Outdoor unit		FDC100VSX	FDC125VSX	FDC140VSX	
Power source		3 Phase 380-415V, 50Hz / 380V, 60Hz			
Nominal cooling capacity (Min~Max)		kW 10.0 (4.0 ~ 11.2)	12.5 (5.0 ~ 14.0)	14.0 (5.0 ~ 16.0)	
Nominal heating capacity (Min~Max)		kW 11.2 (4.0 ~ 16.0)	14.0 (4.0 ~ 18.0)	16.0 (4.0 ~ 20.0)	
Power consumption	Cooling/Heating	kW 2.68 / 3.02	3.49 / 3.77	4.28 / 4.42	
EER/COP	Cooling/Heating	3.73 / 3.71	3.58 / 3.71	3.27 / 3.62	
Inrush current		A 5	5	5	
Max. current		15	15	15	
Sound power level*1	Indoor	Cooling/Heating	65 / 65	67 / 67	
	Outdoor	Cooling/Heating	70 / 70	70 / 70	
Sound pressure level*1	Indoor	Cooling (P-Hi/Hi/Me/Lo)	dB(A) 44 / 38 / 36 / 30	45 / 40 / 34 / 29	
		Heating (P-Hi/Hi/Me/Lo)	44 / 38 / 36 / 30	45 / 40 / 34 / 29	
	Outdoor	Cooling/Heating	48 / 50	48 / 50	
			36 / 28 / 25 / 19	39 / 32 / 26 / 20	
Air flow	Indoor	Cooling (P-Hi/Hi/Me/Lo)	m <sup>3</sup> /min 36 / 28 / 25 / 19	39 / 32 / 26 / 20	
		Heating (P-Hi/Hi/Me/Lo)	36 / 28 / 25 / 19	39 / 32 / 26 / 20	
	Outdoor	Cooling/Heating	100 / 100	100 / 100	
External static pressure*2		Pa	Standard:60 Max:100		
Exterior dimensions	Indoor	HeightxWidthxDepth	mm 280 x 1,370 x 740		
	Outdoor		1,300 x 970 x 370		
Net weight	Indoor		kg 54		
	Outdoor		105		
Ref.piping size	Liquid/Gas	ømm	9.52(3/8") / 15.88(5/8")		
Refrigerant line (one way) length		m	Max.100		
Vertical height differences		Outdoor is higher/lower	m Max.30 / Max.15		
Outdoor operating temperature range	Cooling	°C	-15~43*3		
	Heating		-20~20		
Air filter (option)			Filter kit : UM-FL3EF		
Remote control (option)			wired:RC-EX3A, RC-E5, RCH-E3 wireless:RCN-KIT4-E2		

### NOTES:

- The data are measured under the following conditions(ISO-T1).  
Cooling:Indoor temp. of 27°CDB, 19°CWB, and outdoor temp. of 35°CDB. Heating:Indoor temp. of 20°CDB, and outdoor temp. of 7°CDB, 6°CWB.
- \*1 : Indicates the value in an anechoic chamber. During operation these values are somewhat higher due to ambient conditions.
  - \*2 : External static pressure is changeable to be set by the remote control. MAX external static pressure is "High static pressure" setting. The values of sound pressure level become 5dB(A) higher at external static pressure of 100Pa.
  - \*3 : If a cooling operation is conducted when the outdoor air temperature is -5°C or lower, the outdoor unit should be installed at a place where it is not influenced by natural wind. If wind blows, the low pressure will drop and compressor frequency will increase, this will cause the capacity to drop and may cause the unit to break down.
  - \*4 : The values are for one indoor unit operation. (Multi system only)

The values are for simultaneous Multi operation.

R410A			Hyper Inverter				
Set model name			FDUM71VNXPVH	FDUM100VNXPVH	FDUM125VNXPVH	FDUM140VNXPVF1	FDUM140VNXTVH
			Twin				Triple
Indoor unit			FDUM40VH x 2	FDUM50VH x 2	FDUM60VH x 2	FDUM71VF1 x 2	FDUM50VH x 3
Outdoor unit			FDC71VNX	FDC100VNX	FDC125VNX	FDC140VNX	FDC140VNX
Power source			1 Phase 220-240V, 50Hz / 220V, 60Hz				
Nominal cooling capacity (Min~Max)	kW		7.1 (3.2 ~ 8.0)	10.0 (4.0 ~ 11.2)	12.5 (5.0 ~ 14.0)	14.0 (5.0 ~ 16.0)	14.0 (5.0 ~ 16.0)
Nominal heating capacity (Min~Max)	kW		8.0 (3.6 ~ 9.0)	11.2 (4.0 ~ 12.5)	14.0 (4.0 ~ 17.0)	16.0 (4.0 ~ 18.0)	16.0 (4.0 ~ 18.0)
Power consumption	Cooling/Heating	kW	2.01 / 1.91	2.66 / 3.02	3.26 / 3.66	4.36 / 4.35	4.21 / 4.69
EER/COP	Cooling/Heating		3.53 / 4.19	3.76 / 3.71	3.83 / 3.83	3.21 / 3.68	3.33 / 3.41
Inrush current		A	5	5	5	5	5
Max. current			17	24	26	26	26
Sound power level*1	Indoor*4	Cooling/Heating	60 / 60	60 / 60	60 / 60	65 / 65	60 / 60
	Outdoor	Cooling/Heating	66 / 66	70 / 70	70 / 70	72 / 72	72 / 72
Sound pressure level*1	Indoor*4	Cooling (P-Hi/Hi/Me/Lo)	37 / 32 / 29 / 26	37 / 32 / 29 / 26	36 / 31 / 28 / 25	38 / 33 / 29 / 25	37 / 32 / 29 / 26
	Outdoor	Cooling/Heating	51 / 48	48 / 50	48 / 50	49 / 52	49 / 52
Air flow	Indoor*4	Cooling (P-Hi/Hi/Me/Lo)	13 / 10 / 9 / 8	13 / 10 / 9 / 8	20 / 15 / 13 / 10	24 / 19 / 15 / 10	13 / 10 / 9 / 8
	Outdoor	Cooling/Heating	60 / 50	100 / 100	100 / 100	100 / 100	100 / 100
External static pressure*2		Pa	Standard:35 Max:100				
Exterior dimensions	Indoor	HeightxWidthxDepth	280 x 750 x 635		280 x 950 x 635		280 x 750 x 635
	Outdoor		750 x 880(+88) x 340		1,300 x 970 x 370		
Net weight	Indoor		29		34		29
	Outdoor		60		105		
Ref.piping size	Liquid/Gas	ømm	9.52(3/8") / 15.88(5/8")				
Refrigerant line (one way) length		m	Max.50		Max.100		
Vertical height differences	Outdoor is higher/lower	m	Max.30 / Max.15				
Outdoor operating temperature range	Cooling	°C	-15~43*3				
	Heating		-20~20				
Air filter (option)			Filter kit : UM-FL1EF		Filter kit : UM-FL2EF		Filter kit : UM-FL1EF
Remote control (option)			wired:RC-EX3A, RC-E5, RCH-E3 wireless:RCN-KIT4-E2				

The values are for simultaneous Multi operation.

R410A			Hyper Inverter			
Set model name			FDUM100VSXPVH	FDUM125VSXPVH	FDUM140VSXPVF1	FDUM140VSXTVH
			Twin			Triple
Indoor unit			FDUM50VH x 2	FDUM60VH x 2	FDUM71VF1 x 2	FDUM50VH x 3
Outdoor unit			FDC100VSX	FDC125VSX	FDC140VSX	FDC140VSX
Power source			3 Phase 380-415V, 50Hz / 380V, 60Hz			
Nominal cooling capacity (Min~Max)	kW		10.0 (4.0 ~ 11.2)	12.5 (5.0 ~ 14.0)	14.0 (5.0 ~ 16.0)	14.0 (5.0 ~ 16.0)
Nominal heating capacity (Min~Max)	kW		11.2 (4.0 ~ 16.0)	14.0 (4.0 ~ 18.0)	16.0 (4.0 ~ 20.0)	16.0 (4.0 ~ 20.0)
Power consumption	Cooling/Heating	kW	2.66 / 3.02	3.26 / 3.66	4.36 / 4.35	4.21 / 4.69
EER/COP	Cooling/Heating		3.76 / 3.71	3.83 / 3.83	3.21 / 3.68	3.33 / 3.41
Inrush current		A	5	5	5	5
Max. current			15	15	15	15
Sound power level*1	Indoor*4	Cooling/Heating	60 / 60	60 / 60	65 / 65	60 / 60
	Outdoor	Cooling/Heating	70 / 70	70 / 70	72 / 72	72 / 72
Sound pressure level*1	Indoor*4	Cooling (P-Hi/Hi/Me/Lo)	37 / 32 / 29 / 26	36 / 31 / 28 / 25	38 / 33 / 29 / 25	37 / 32 / 29 / 26
	Outdoor	Cooling/Heating	48 / 50	48 / 50	49 / 52	49 / 52
Air flow	Indoor*4	Cooling (P-Hi/Hi/Me/Lo)	13 / 10 / 9 / 8	20 / 15 / 13 / 10	24 / 19 / 15 / 10	13 / 10 / 9 / 8
	Outdoor	Cooling/Heating	100 / 100	100 / 100	100 / 100	100 / 100
External static pressure*2		Pa	Standard:35 Max:100			
Exterior dimensions	Indoor	HeightxWidthxDepth	280 x 750 x 635		280 x 950 x 635	
	Outdoor				1,300 x 970 x 370	
Net weight	Indoor		29		34	
	Outdoor		60		105	
Ref.piping size	Liquid/Gas	ømm	9.52(3/8") / 15.88(5/8")			
Refrigerant line (one way) length		m	Max.100			
Vertical height differences	Outdoor is higher/lower	m	Max.30 / Max.15			
Outdoor operating temperature range	Cooling	°C	-15~43*3			
	Heating		-20~20			
Air filter (option)			Filter kit : UM-FL1EF		Filter kit : UM-FL2EF	
Remote control (option)			wired:RC-EX3A, RC-E5, RCH-E3 wireless:RCN-KIT4-E2			

## SPECIFICATIONS - FDUM -

R410A			Micro Inverter		
Set model name			FDUM100VNAVF2	FDUM125VNAVF	FDUM140VNAVF
Indoor unit			FDUM100VF2	FDUM125VF	FDUM140VF
Outdoor unit			FDC100VNA	FDC125VNA	FDC140VNA
Power source			1 Phase 220-240V, 50Hz / 220V, 60Hz		
Nominal cooling capacity (Min-Max)			kW 10.0 ( 4.0 ~ 11.2 )	12.5 ( 5.0 ~ 14.0 )	13.6 ( 5.0 ~ 14.5 )
Nominal heating capacity (Min-Max)			kW 11.2 ( 4.0 ~ 12.5 )	14.0 ( 4.0 ~ 16.0 )	15.5 ( 4.0 ~ 16.5 )
Power consumption			Cooling/Heating kW 2.84 / 2.78	4.36 / 3.69	4.93 / 4.21
EER/COP			Cooling/Heating 3.52 / 4.03	2.87 / 3.79	2.76 / 3.68
Inrush current			A 5	5	5
Max. current			26	26	27
Sound power level*1	Indoor	Cooling/Heating	65 / 65	67 / 67	70 / 70
	Outdoor	Cooling/Heating	70 / 70	71 / 71	73 / 73
Sound pressure level*1	Indoor	Cooling (P-Hi/Hi/Me/Lo)	dB(A) 44 / 38 / 36 / 30	45 / 40 / 34 / 29	47 / 40 / 35 / 30
		Heating (P-Hi/Hi/Me/Lo)			
	Outdoor	Cooling/Heating	54 / 56	55 / 57	57 / 59
		Cooling/Heating	36 / 28 / 25 / 19	39 / 32 / 26 / 20	48 / 35 / 28 / 22
Air flow	Indoor	Heating (P-Hi/Hi/Me/Lo)	m³/min 36 / 28 / 25 / 19	39 / 32 / 26 / 20	48 / 35 / 28 / 22
	Outdoor	Cooling/Heating			
External static pressure*2			Pa Standard:60 Max:100		
Exterior dimensions	Indoor	HeightxWidthxDepth	mm 280 x 1,370 x 740		
	Outdoor		845 x 970 x 370		
Net weight	Indoor		kg 54		
	Outdoor		80		
Ref.piping size			Liquid/Gas ømm 9.52(3/8") / 15.88(5/8")		
Refrigerant line (one way) length			m Max.50		
Vertical height differences			Outdoor is higher/lower m Max.50 / Max.15		
Outdoor operating temperature range			Cooling °C -15~50*3		
			Heating -20~20		
Air filter (option)			Filter kit : UM-FL3EF		
Remote control (option)			wired:RC-EX3A, RC-E5, RCH-E3 wireless:RCN-KIT4-E2		

R410A			Micro Inverter		
Set model name			FDUM100VSAVF2	FDUM125VSAVF	FDUM140VSAVF
Indoor unit			FDUM100VF2	FDUM125VF	FDUM140VF
Outdoor unit			FDC100VSA	FDC125VSA	FDC140VSA
Power source			3 Phase 380-415V, 50Hz / 380V, 60Hz		
Nominal cooling capacity (Min-Max)			kW 10.0 ( 4.0 ~ 11.2 )	12.5 ( 5.0 ~ 14.0 )	13.6 ( 5.0 ~ 14.5 )
Nominal heating capacity (Min-Max)			kW 11.2 ( 4.0 ~ 12.5 )	14.0 ( 4.0 ~ 16.0 )	15.5 ( 4.0 ~ 16.5 )
Power consumption			Cooling/Heating kW 2.84 / 2.78	4.36 / 3.69	4.93 / 4.21
EER/COP			Cooling/Heating 3.52 / 4.03	2.87 / 3.79	2.76 / 3.68
Inrush current			A 5	5	5
Max. current			17	17	18
Sound power level*1	Indoor	Cooling/Heating	65 / 65	67 / 67	70 / 70
	Outdoor	Cooling/Heating	70 / 70	71 / 71	73 / 73
Sound pressure level*1	Indoor	Cooling (P-Hi/Hi/Me/Lo)	dB(A) 44 / 38 / 36 / 30	45 / 40 / 34 / 29	47 / 40 / 35 / 30
		Heating (P-Hi/Hi/Me/Lo)			
	Outdoor	Cooling/Heating	54 / 56	55 / 57	57 / 59
		Cooling/Heating	36 / 28 / 25 / 19	39 / 32 / 26 / 20	48 / 35 / 28 / 22
Air flow	Indoor	Heating (P-Hi/Hi/Me/Lo)	m³/min 36 / 28 / 25 / 19	39 / 32 / 26 / 20	48 / 35 / 28 / 22
	Outdoor	Cooling/Heating			
External static pressure*2			Pa Standard:60 Max:100		
Exterior dimensions	Indoor	HeightxWidthxDepth	mm 280 x 1,370 x 740		
	Outdoor		845 x 970 x 370		
Net weight	Indoor		kg 54		
	Outdoor		82		
Ref.piping size			Liquid/Gas ømm 9.52(3/8") / 15.88(5/8")		
Refrigerant line (one way) length			m Max.50		
Vertical height differences			Outdoor is higher/lower m Max.50 / Max.15		
Outdoor operating temperature range			Cooling °C -15~50*3		
			Heating -20~20		
Air filter (option)			Filter kit : UM-FL3EF		
Remote control (option)			wired:RC-EX3A, RC-E5, RCH-E3 wireless:RCN-KIT4-E2		

### NOTES:

The data are measured under the following conditions(ISO-T1).

Cooling:Indoor temp. of 27°CDB, 19°CWB, and outdoor temp. of 35°CDB. Heating:Indoor temp. of 20°CDB, and outdoor temp. of 7°CDB, 6°CWB.

\*1 : Indicates the value in an anechoic chamber. During operation these values are somewhat higher due to ambient conditions.

\*2 : External static pressure is changeable to be set by the remote control. MAX external static pressure is "High static pressure" setting. The values of sound pressure level become 5dB(A) higher at external static pressure of 100Pa.

\*3 : If a cooling operation is conducted when the outdoor air temperature is -5°C or lower, the outdoor unit should be installed at a place where it is not influenced by natural wind. If wind blows, the low pressure will drop and compressor frequency will increase, this will cause the capacity to drop and may cause the unit to break down.

\*4 : The values are for one indoor unit operation. (Multi system only)

The values are for simultaneous Multi operation.

R410A			Micro Inverter		
Set model name			FDUM100VNAPVH	FDUM125VNAPVH	FDUM140VNAPVF1
			Twin		
Indoor unit			FDUM50VH x 2	FDUM60VH x 2	FDUM71VF1 x 2
Outdoor unit			FDC100VNA	FDC125VNA	FDC140VNA
Power source			1 Phase 220-240V, 50Hz / 220V, 60Hz		
Nominal cooling capacity (Min~Max)		kW	10.0 ( 4.0 ~ 11.2 )	12.5 ( 5.0 ~ 14.0 )	13.6 ( 5.0 ~ 14.5 )
Nominal heating capacity (Min~Max)		kW	11.2 ( 4.0 ~ 12.5 )	14.0 ( 4.0 ~ 16.0 )	15.5 ( 4.0 ~ 16.5 )
Power consumption	Cooling/Heating	kW	3.25 / 3.21	4.53 / 3.75	5.02 / 4.20
EER/COP	Cooling/Heating		3.08 / 3.49	2.76 / 3.73	2.71 / 3.69
Inrush current		A	5	5	5
Max. current			26	26	27
Sound power level*1	Indoor*4	Cooling/Heating	60 / 60	60 / 60	65 / 65
	Outdoor	Cooling/Heating	70 / 70	71 / 71	73 / 73
Sound pressure level*1	Indoor*4	Cooling (P-Hi/Hi/Me/Lo)	37 / 32 / 29 / 26	36 / 31 / 28 / 25	38 / 33 / 29 / 25
		Heating (P-Hi/Hi/Me/Lo)	37 / 32 / 29 / 26	36 / 31 / 28 / 25	38 / 33 / 29 / 25
Air flow	Indoor*4	Cooling/Heating	54 / 56	55 / 57	57 / 59
		Cooling (P-Hi/Hi/Me/Lo)	13 / 10 / 9 / 8	20 / 15 / 13 / 10	24 / 19 / 15 / 10
		Heating (P-Hi/Hi/Me/Lo)	13 / 10 / 9 / 8	20 / 15 / 13 / 10	24 / 19 / 15 / 10
	Outdoor	Cooling/Heating	75 / 73	75 / 73	75 / 73
External static pressure*2			Pa Standard:35 Max:100		
Exterior dimensions	Indoor	HeightxWidthxDepth	280 x 750 x 635		280 x 950 x 635
	Outdoor		845 x 970 x 370		
Net weight	Indoor		29		34
	Outdoor		80		
Ref.piping size	Liquid/Gas		9.52(3/8") / 15.88(5/8")		
Refrigerant line (one way) length			m Max.50		
Vertical height differences			m Max.50 / Max.15		
Outdoor operating temperature range	Cooling	°C	-15~50*3		
	Heating		-20~20		
Air filter (option)			Filter kit : UM-FL1EF		Filter kit : UM-FL2EF
Remote control (option)			wired:RC-EX3A, RC-E5, RCH-E3 wireless:RCN-KIT4-E2		

The values are for simultaneous Multi operation.

R410A			Micro Inverter		
Set model name			FDUM140VNATVH	FDUM100VSAPVH	
			Triple		Twin
Indoor unit			FDUM50VH x 3	FDUM50VH x 2	
Outdoor unit			FDC140VNA	FDC100VSA	
Power source			1 Phase 220-240V, 50Hz / 220V, 60Hz	3 Phase 380-415V, 50Hz / 380V, 60Hz	
Nominal cooling capacity (Min~Max)		kW	13.6 ( 5.0 ~ 14.5 )	10.0 ( 4.0 ~ 11.2 )	
Nominal heating capacity (Min~Max)		kW	15.5 ( 4.0 ~ 16.5 )	11.2 ( 4.0 ~ 12.5 )	
Power consumption	Cooling/Heating	kW	5.02 / 4.20	3.25 / 3.21	
EER/COP	Cooling/Heating		2.71 / 3.69	3.08 / 3.49	
Inrush current		A	5	5	
Max. current			27	17	
Sound power level*1	Indoor*4	Cooling/Heating	60 / 60	60 / 60	
	Outdoor	Cooling/Heating	73 / 73	70 / 70	
Sound pressure level*1	Indoor*4	Cooling (P-Hi/Hi/Me/Lo)	37 / 32 / 29 / 26	37 / 32 / 29 / 26	
		Heating (P-Hi/Hi/Me/Lo)	37 / 32 / 29 / 26	37 / 32 / 29 / 26	
Air flow	Indoor*4	Cooling/Heating	57 / 59	54 / 56	
		Cooling (P-Hi/Hi/Me/Lo)	13 / 10 / 9 / 8	13 / 10 / 9 / 8	
		Heating (P-Hi/Hi/Me/Lo)	13 / 10 / 9 / 8	13 / 10 / 9 / 8	
	Outdoor	Cooling/Heating	75 / 73	75 / 73	
External static pressure*2			Pa Standard:35 Max:100		
Exterior dimensions	Indoor	HeightxWidthxDepth	280 x 750 x 635		
	Outdoor		845 x 970 x 370		
Net weight	Indoor		29		
	Outdoor		80		82
Ref.piping size	Liquid/Gas		9.52(3/8") / 15.88(5/8")		
Refrigerant line (one way) length			m Max.50		
Vertical height differences			m Max.50 / Max.15		
Outdoor operating temperature range	Cooling	°C	-15~50*3		
	Heating		-20~20		
Air filter (option)			Filter kit : UM-FL1EF		
Remote control (option)			wired:RC-EX3A, RC-E5, RCH-E3 wireless:RCN-KIT4-E2		



# SPECIFICATIONS - FDUM -

The values are for simultaneous Multi operation.

R410A		Micro Inverter			
Set model name		FDUM125VSAPVH	FDUM140VSAPVF1	FDUM200VSAPVF2	FDUM250VSAPVF
		Twin			
Indoor unit		FDUM60VH x 2	FDUM71VF1 x 2	FDUM100VF2 x 2	FDUM125VF x 2
Outdoor unit		FDC125VSA	FDC140VSA	FDC200VSA	FDC250VSA
Power source		3 Phase 380-415V, 50Hz / 380V, 60Hz			
Nominal cooling capacity (Min~Max)	kW	12.5 ( 5.0 ~ 14.0 )	13.6 ( 5.0 ~ 14.5 )	19.0 ( 5.2 ~ 22.4 )	24.0 ( 6.9 ~ 28.0 )
Nominal heating capacity (Min~Max)	kW	14.0 ( 4.0 ~ 16.0 )	15.5 ( 4.0 ~ 16.5 )	22.4 ( 3.3 ~ 25.0 )	27.0 ( 5.5 ~ 31.5 )
Power consumption	Cooling/Heating	4.53 / 3.75	5.02 / 4.20	6.51 / 6.04	8.33 / 7.52
EER/COP	Cooling/Heating	2.76 / 3.73	2.71 / 3.69	2.92 / 3.71	2.88 / 3.59
Inrush current		5	5	5	5
Max. current		17	18	22	24
Sound power level*1	Indoor*4	Cooling/Heating	60 / 60	65 / 65	65 / 65
	Outdoor	Cooling/Heating	71 / 71	73 / 73	72 / 74
Sound pressure level*1	Indoor*4	Cooling (P-Hi/Hi/Me/Lo)	36 / 31 / 28 / 25	38 / 33 / 29 / 25	44 / 38 / 36 / 30
	Outdoor	Heating (P-Hi/Hi/Me/Lo)	36 / 31 / 28 / 25	38 / 33 / 29 / 25	44 / 38 / 36 / 30
Air flow	Indoor*4	Cooling/Heating	55 / 57	57 / 59	58 / 59
	Outdoor	Cooling/Heating	20 / 15 / 13 / 10	24 / 19 / 15 / 10	36 / 28 / 25 / 19
External static pressure*2	Pa	Standard:35 Max:100		Standard:60 Max:100	
Exterior dimensions	Indoor	HeightxWidthxDepth	280 x 950 x 635	280 x 1,370 x 740	
	Outdoor	HeightxWidthxDepth	845 x 970 x 370	1,300 x 970 x 370	1,505 x 970 x 370
Net weight	Indoor		34	54	
	Outdoor		82	115	143
Ref.piping size	Liquid/Gas	ømm	9.52(3/8") / 15.88(5/8")	9.52(3/8") / 22.22(7/8")	12.7(1/2") / 22.22(7/8")
Refrigerant line (one way) length		m	Max.50	Max.70	
Vertical height differences	Outdoor is higher/lower	m	Max.50 / Max.15	Max.30 / Max.15	
Outdoor operating temperature range	Cooling	°C	-15~50*3		
	Heating	°C	-20~20	-15~20	
Air filter (option)			Filter kit : UM-FL2EF	Filter kit : UM-FL3EF	
Remote control (option)			wired:RC-EX3A, RC-E5, RCH-E3 wireless:RCN-KIT4-E2		

The values are for simultaneous Multi operation.

R410A		Micro Inverter		
Set model name		FDUM140VSATVH	FDUM200VSATVF1	
		Triple		
Indoor unit		FDUM50VH x 3	FDUM71VF1 x 3	
Outdoor unit		FDC140VSA	FDC200VSA	
Power source		3 Phase 380-415V, 50Hz / 380V, 60Hz		
Nominal cooling capacity (Min~Max)	kW	13.6 ( 5.0 ~ 14.5 )	19.0 ( 5.2 ~ 22.4 )	
Nominal heating capacity (Min~Max)	kW	15.5 ( 4.0 ~ 16.5 )	22.4 ( 3.3 ~ 25.0 )	
Power consumption	Cooling/Heating	5.02 / 4.20	6.46 / 6.15	
EER/COP	Cooling/Heating	2.71 / 3.69	2.94 / 3.64	
Inrush current		5	5	
Max. current		18	22	
Sound power level*1	Indoor*4	Cooling/Heating	60 / 60	
	Outdoor	Cooling/Heating	73 / 73	
Sound pressure level*1	Indoor*4	Cooling (P-Hi/Hi/Me/Lo)	37 / 32 / 29 / 26	
	Outdoor	Heating (P-Hi/Hi/Me/Lo)	37 / 32 / 29 / 26	
Air flow	Indoor*4	Cooling/Heating	57 / 59	
	Outdoor	Cooling/Heating	13 / 10 / 9 / 8	
External static pressure*2	Pa	Standard:35 Max:100		
Exterior dimensions	Indoor	HeightxWidthxDepth	280 x 750 x 635	
	Outdoor	HeightxWidthxDepth	845 x 970 x 370	
Net weight	Indoor		29	
	Outdoor		82	
Ref.piping size	Liquid/Gas	ømm	9.52(3/8") / 15.88(5/8")	
Refrigerant line (one way) length		m	Max.50	
Vertical height differences	Outdoor is higher/lower	m	Max.50 / Max.15	
Outdoor operating temperature range	Cooling	°C	-15~50*3	
	Heating	°C	-20~20	-15~20
Air filter (option)			Filter kit : UM-FL1EF	
Remote control (option)			wired:RC-EX3A, RC-E5, RCH-E3 wireless:RCN-KIT4-E2	

## NOTES:

- The data are measured under the following conditions(ISO-T1).  
 Cooling:Indoor temp. of 27°CDB, 19°CWB, and outdoor temp. of 35°CDB. Heating:Indoor temp. of 20°CDB, and outdoor temp. of 7°CDB, 6°CWB.  
 \*1 : Indicates the value in an anechoic chamber. During operation these values are somewhat higher due to ambient conditions.  
 \*2 : External static pressure is changeable to be set by the remote control. MAX external static pressure is "High static pressure" setting. The values of sound pressure level become 5dB(A) higher at external static pressure of 100Pa.  
 \*3 : If a cooling operation is conducted when the outdoor air temperature is -5°C or lower, the outdoor unit should be installed at a place where it is not influenced by natural wind. If wind blows, the low pressure will drop and compressor frequency will increase, this will cause the capacity to drop and may cause the unit to break down.  
 \*4 : The values are for one indoor unit operation. (Multi system only)

R410A			Standard Inverter		
Set model name			FDUM71VNPVF1	FDUM90VNP1VF2	FDUM100VNP1VF2
Indoor unit			FDUM71VF1	FDUM100VF2	FDUM100VF2
Outdoor unit			FDC71VNP	FDC90VNP1	FDC100VNP
Power source			1 Phase 220-240V, 50Hz / 220V, 60Hz		
Nominal cooling capacity (Min~Max)		kW	7.1 ( 1.4 ~ 7.1 )	9.0 ( 1.9 ~ 9.0 )	10.0 ( 2.8 ~ 11.2 )
Nominal heating capacity (Min~Max)		kW	7.1 ( 1.0 ~ 7.1 )	9.0 ( 1.5 ~ 9.0 )	11.2 ( 2.5 ~ 12.5 )
Power consumption	Cooling/Heating	kW	2.60 / 1.89	2.69 / 2.25	3.00 / 2.93
EER/COP	Cooling/Heating		2.73 / 3.76	3.35 / 4.00	3.33 / 3.82
Inrush current		A	5	5	5
Max. current			14.5	18.0	22.0
Sound power level*1	Indoor	Cooling/Heating	65 / 65	65 / 65	65 / 65
	Outdoor	Cooling/Heating	67 / 67	69 / 69	70 / 70
Sound pressure level*1	Indoor	Cooling (P-Hi/Hi/Me/Lo)	38 / 33 / 29 / 25	44 / 38 / 36 / 30	44 / 38 / 36 / 30
		Heating (P-Hi/Hi/Me/Lo)	38 / 33 / 29 / 25	44 / 38 / 36 / 30	44 / 38 / 36 / 30
Air flow	Indoor	Cooling (P-Hi/Hi/Me/Lo)	24 / 19 / 15 / 10	36 / 28 / 25 / 19	36 / 28 / 25 / 19
		Heating (P-Hi/Hi/Me/Lo)	24 / 19 / 15 / 10	36 / 28 / 25 / 19	36 / 28 / 25 / 19
	Outdoor	Cooling/Heating	36 / 36	63 / 49.5	75 / 79
External static pressure*2		Pa	Standard:35 Max:100	Standard:60 Max:100	
Exterior dimensions	Indoor	HeightxWidthxDepth	280 x 950 x 635		
	Outdoor		640 x 800(+71) x 290	750 x 880(+88) x 340	845 x 970 x 370
Net weight	Indoor		34		
	Outdoor		45	57	70
Ref.piping size	Liquid/Gas	ømm	6.35(1/4") / 12.7(1/2")		
Refrigerant line (one way) length		m	Max.30		
Vertical height differences		Outdoor is higher/lower	Max.20 / Max.20		
Outdoor operating temperature range	Cooling	°C	-15~46*3		
	Heating		-15~20		
Air filter (option)			Filter kit : UM-FL2EF	Filter kit : UM-FL3EF	
Remote control (option)			wired:RC-EX3A, RC-E5, RCH-E3 wireless:RCN-KIT4-E2		

# SRK Indoor Unit Wall Mounted



**SRK 50•60**  
Only used with  
Multi System.

**SRK 100**  
Common to the  
both case of  
Single and Multi



- Energy Saving
- Home Leave
- Hi Power
- Silent Operation
- Flap Control
- Weekly Timer



### Remote control (option)

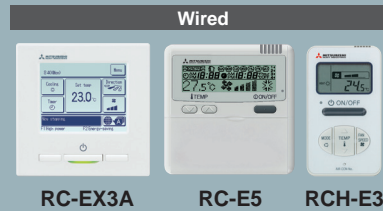

\*Not all functions available with all remote control options.

## Elegant Timeless Design

The SRK series air-conditioners have been stylishly designed with rounded contours that fit beautifully into any of Europe's diverse interior settings. The design was created by the Italian industrial design studio Tensa srl, based in Milan, to respond to a broad spectrum of local user needs.

## Jet Technology

We used the same aerodynamic analysis technology as used in developing jet engines.



CFD (computational fluid dynamics), used in blade shape design of jet engines, has been applied to the design of air channels in air conditioners to develop the ideal air channel system (air circulation).

The airflow of the jets created in this system enable a large volume of air to be blown with minimum power consumption, yet the air flow is uniform, quiet and reaches points a long distance from the blower.

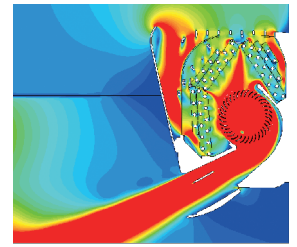

Fast ← → Slow

Colors in the figure show the air speed.

## Long Reach Air Flow

Powerful airflow is realized by Jet technology. Good for large living rooms and shops, which Increase comfort.



## Indoor Unit Connection

Max three indoor units are connectable to one outdoor unit.

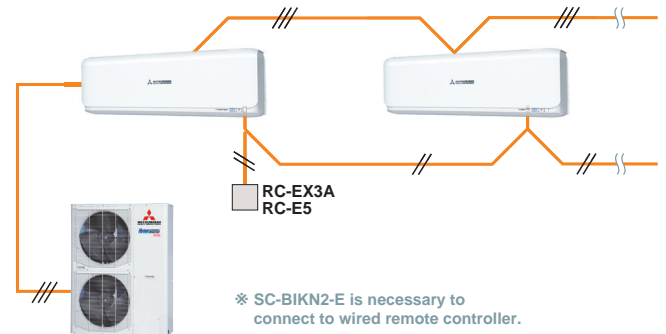

\* SC-BIKN2-E is necessary to connect to wired remote controller.

## Flap Control System

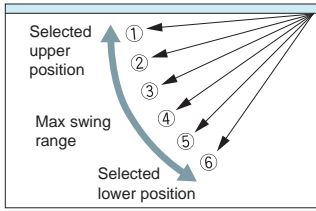

The flap can swing within the range of upper and lower flap position selected.

※The wireless remote control is not applicable to the flap control system.

## SC-BIKN2-E connection (Option)

Interface kit can be built into indoor unit. (SRK50•60)

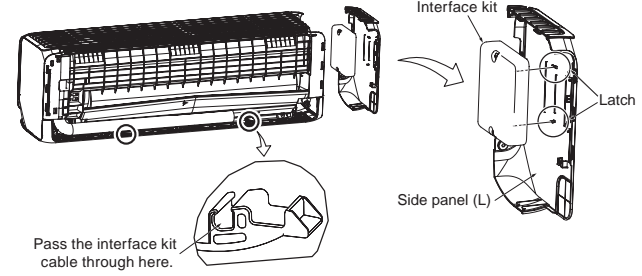

## OUTDOOR UNIT

FDC	<i>Hyper Inverter</i>	Micro Inverter		Standard Inverter
	100~140VN(S)X	100VN(S)A	200VSA	100VNP
model				
Chargeless	30m	30m		15m
Height x Width x Depth (mm)	1,300 x 970 x 370	845 x 970 x 370	1,300 x 970 x 370	845 x 970 x 370

## DIMENSIONS (Unit:mm) - SRK -

SRK50ZSX-W, 60ZSX-W

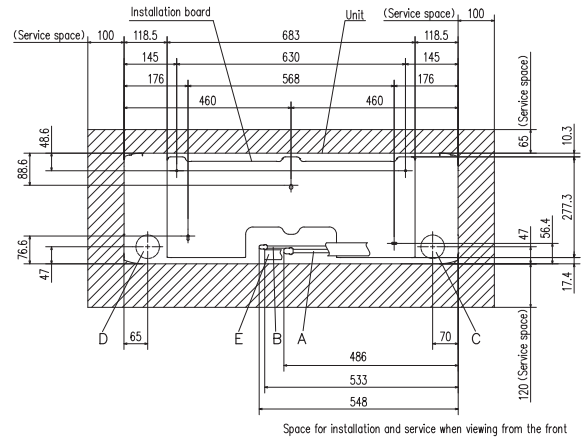
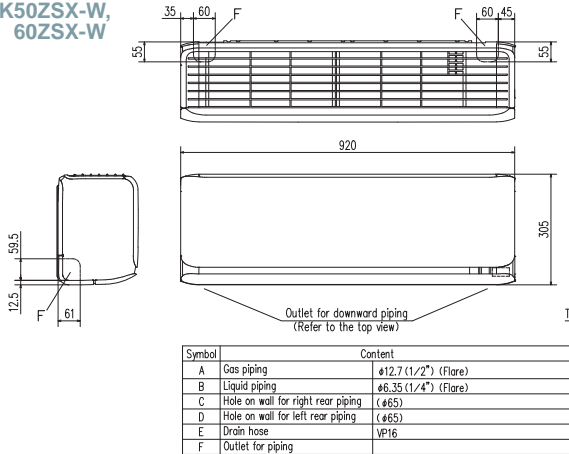

SRK100ZR-S

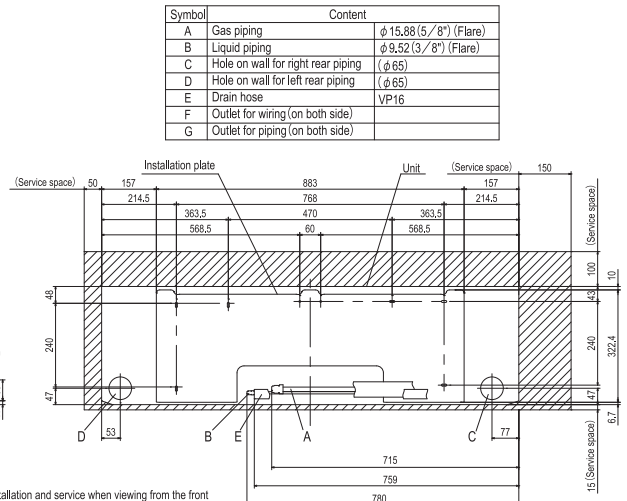
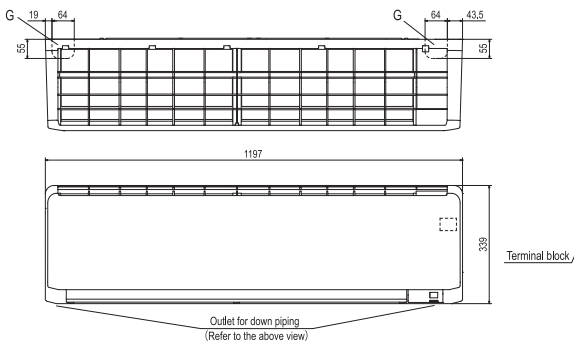



## SPECIFICATIONS - SRK -

The values are for simultaneous Multi operation.

R410A		Hyper Inverter			
Set model name		SRK100VNXPSX	SRK125VNXPSX	SRK140VNXTZSX	
		Twin		Triple	
Indoor unit		SRK50ZSX-W x 2	SRK60ZSX-W x 2	SRK50ZSX-W x 3	
Outdoor unit		FDC100VNX	FDC125VNX	FDC140VNX	
Power source		1 Phase 220-240V, 50Hz / 220V, 60Hz			
Nominal cooling capacity (Min~Max)	kW	10.0 ( 4.0 ~ 11.2 )	12.5 ( 5.0 ~ 14.0 )	14.0 ( 5.0 ~ 16.0 )	
Nominal heating capacity (Min~Max)	kW	11.2 ( 4.0 ~ 12.5 )	14.0 ( 4.0 ~ 17.0 )	16.0 ( 4.0 ~ 18.0 )	
Power consumption	Cooling/Heating kW	2.66 / 2.60	3.60 / 3.48	3.98 / 3.68	
EER/COP	Cooling/Heating	3.76 / 4.31	3.47 / 4.02	3.52 / 4.35	
Inrush current	A	5	5	5	
Max. current		24	26	26	
Sound power level*1	Indoor*3	Cooling/Heating	59 / 62	62 / 63	59 / 62
	Outdoor	Cooling/Heating	70 / 70	70 / 70	72 / 72
Sound pressure level*1	Indoor*3	Cooling (Hi/Me/Lo/Ulo)	44 / 39 / 31 / 22	46 / 41 / 33 / 22	44 / 39 / 31 / 22
		Heating (Hi/Me/Lo/Ulo)	46 / 41 / 33 / 23	46 / 42 / 34 / 23	46 / 41 / 33 / 23
	Outdoor	Cooling/Heating	48 / 50	48 / 50	49 / 52
Air flow	Indoor*3	Cooling (Hi/Me/Lo/Ulo)	14.3 / 12.4 / 7.8 / 5.4	16.3 / 13.4 / 8.9 / 5.4	14.3 / 12.4 / 7.8 / 5.4
		Heating (Hi/Me/Lo/Ulo)	17.3 / 14.3 / 9.8 / 6.2	17.8 / 13.7 / 10.9 / 6.2	17.3 / 14.3 / 9.8 / 6.2
	Outdoor	Cooling/Heating	100 / 100	100 / 100	100 / 100
Exterior dimensions	Indoor	HeightxWidthxDepth	305 x 920 x 220		
	Outdoor		1,300 x 970 x 370		
Net weight	Indoor		13		
	Outdoor		105		
Ref.piping size	Liquid/Gas		9.52(3/8") / 15.88(5/8")		
Refrigerant line (one way) length			Max.100		
Vertical height differences	Outdoor is higher/lower		Max.30 / Max.15		
Outdoor operating temperature range	Cooling		-15~43*2		
	Heating		-20~20		
Air filter, Q'ty			Polypropylene net x 2(washable)		
Remote control (option)			wired:RC-EX3A, RC-E5, RCH-E3 & Interface kit:SC-BIKN2-E		

The values are for simultaneous Multi operation.

R410A		Hyper Inverter			
Set model name		SRK100VXSXPZSX	SRK125VXSXPZSX	SRK140VXSXTZSX	
		Twin		Triple	
Indoor unit		SRK50ZSX-W x 2	SRK60ZSX-W x 2	SRK50ZSX-W x 3	
Outdoor unit		FDC100VVSX	FDC125VVSX	FDC140VVSX	
Power source		3 Phase 380-415V, 50Hz / 380V, 60Hz			
Nominal cooling capacity (Min~Max)	kW	10.0 ( 4.0 ~ 11.2 )	12.5 ( 5.0 ~ 14.0 )	14.0 ( 5.0 ~ 16.0 )	
Nominal heating capacity (Min~Max)	kW	11.2 ( 4.0 ~ 16.0 )	14.0 ( 4.0 ~ 18.0 )	16.0 ( 4.0 ~ 20.0 )	
Power consumption	Cooling/Heating kW	2.66 / 2.60	3.60 / 3.48	3.98 / 3.68	
EER/COP	Cooling/Heating	3.76 / 4.31	3.47 / 4.02	3.52 / 4.35	
Inrush current	A	5	5	5	
Max. current		15	15	15	
Sound power level*1	Indoor*3	Cooling/Heating	59 / 62	62 / 63	59 / 62
	Outdoor	Cooling/Heating	70 / 70	70 / 70	72 / 72
Sound pressure level*1	Indoor*3	Cooling (Hi/Me/Lo/Ulo)	44 / 39 / 31 / 22	46 / 41 / 33 / 22	44 / 39 / 31 / 22
		Heating (Hi/Me/Lo/Ulo)	46 / 41 / 33 / 23	46 / 42 / 34 / 23	46 / 41 / 33 / 23
	Outdoor	Cooling/Heating	48 / 50	48 / 50	49 / 52
Air flow	Indoor*3	Cooling (Hi/Me/Lo/Ulo)	14.3 / 12.4 / 7.8 / 5.4	16.3 / 13.4 / 8.9 / 5.4	14.3 / 12.4 / 7.8 / 5.4
		Heating (Hi/Me/Lo/Ulo)	17.3 / 14.3 / 9.8 / 6.2	17.8 / 13.7 / 10.9 / 6.2	17.3 / 14.3 / 9.8 / 6.2
	Outdoor	Cooling/Heating	100 / 100	100 / 100	100 / 100
Exterior dimensions	Indoor	HeightxWidthxDepth	305 x 920 x 220		
	Outdoor		1,300 x 970 x 370		
Net weight	Indoor		13		
	Outdoor		105		
Ref.piping size	Liquid/Gas		9.52(3/8") / 15.88(5/8")		
Refrigerant line (one way) length			Max.100		
Vertical height differences	Outdoor is higher/lower		Max.30 / Max.15		
Outdoor operating temperature range	Cooling		-15~43*2		
	Heating		-20~20		
Air filter, Q'ty			Polypropylene net x 2(washable)		
Remote control (option)			wired:RC-EX3A, RC-E5, RCH-E3 & Interface kit:SC-BIKN2-E		

### NOTES:

The data are measured under the following conditions (ISO-T1).  
 Cooling:Indoor temp. of 27°CDB, 19°CWB, and outdoor temp. of 35°CDB. Heating:Indoor temp. of 20°CDB, and outdoor temp. of 7°CDB, 6°CWB.  
 \*1 : Indicates the value in an anechoic chamber. During operation these values are somewhat higher due to ambient conditions.  
 \*2 : If a cooling operation is conducted when the outdoor air temperature is -5°C or lower, the outdoor unit should be installed at a place where it is not influenced by natural wind. If wind blows, the low pressure will drop and compressor frequency will increase, this will cause the capacity to drop and may cause the unit to break down.  
 \*3 : The values are for one indoor unit operation. (Multi system only)

R410A		Micro Inverter		
Set model name		SRK100VNAZR	SRK100VSAZR	
Indoor unit		SRK100ZR-S	SRK100ZR-S	
Outdoor unit		FDC100VNA	FDC100VSA	
Power source		1 Phase 220-240V, 50Hz / 220V, 60Hz	3 Phase 380-415V, 50Hz / 380V, 60Hz	
Nominal cooling capacity (Min~Max)		10.0 ( 4.0 ~ 11.2 )	10.0 ( 4.0 ~ 11.2 )	
Nominal heating capacity (Min~Max)		11.2 ( 4.0 ~ 12.5 )	11.2 ( 4.0 ~ 12.5 )	
Power consumption	Cooling/Heating	3.19 / 2.78	3.19 / 2.78	
EER/COP	Cooling/Heating	3.13 / 4.03	3.13 / 4.03	
Inrush current		5	5	
Max. current		24	15	
Sound power level*1	Indoor	Cooling/Heating	63 / 63	
	Outdoor	Cooling/Heating	70 / 70	
Sound pressure level*1	Indoor	Cooling (Hi/Me/Lo/Ulo)	48 / 45 / 40 / 27	
		Heating (Hi/Me/Lo/Ulo)	48 / 43 / 38 / 30	
	Outdoor	Cooling/Heating	54 / 56	
			54 / 56	
Air flow	Indoor	Cooling (Hi/Me/Lo/Ulo)	24.5 / 21.3 / 17.6 / 10.4	
		Heating (Hi/Me/Lo/Ulo)	27.5 / 23.2 / 19.1 / 13.6	
	Outdoor	Cooling/Heating	75 / 73	
Exterior dimensions	Indoor	HeightxWidthxDepth	339 / 1,197 / 262	
	Outdoor		845 / 970 / 370	
Net weight	Indoor		16.5	
	Outdoor		82	
Ref.piping size	Liquid/Gas	ømm	9.52(3/8") / 15.88(5/8")	
Refrigerant line (one way) length		m	Max.50	
Vertical height differences		Outdoor is higher/lower	m	Max.50 / Max.15
Outdoor operating temperature range	Cooling	°C	-15~50*2	
	Heating		-20~20	
Air filter, Q'ty			Polypropylene net x2 (Washable)	
Remote control (option)			wired:RC-EX3A, RC-E5, RCH-E3 & Interface kit:SC-BIKN2-E	

The values are for simultaneous Multi operation.(except Single case)

R410A		Micro Inverter		Standard Inverter		
Set model name		SRK200VSAPZR	SRK100VNP1ZR			
Indoor unit		SRK100ZR-S x 2	SRK100ZR-S			
Outdoor unit		FDC200VSA	FDC100VNP			
Power source		3 Phase 380-415V, 50Hz / 380V, 60Hz	1 Phase 220-240V, 50Hz / 220V, 60Hz			
Nominal cooling capacity (Min~Max)		19.0 ( 5.2 ~ 22.4 )	10.0 ( 2.4 ~ 10.5 )			
Nominal heating capacity (Min~Max)		22.4 ( 3.3 ~ 25.0 )	11.2 ( 3.2 ~ 11.5 )			
Power consumption	Cooling/Heating	7.52 / 7.41	3.09 / 3.28			
EER/COP	Cooling/Heating	2.53 / 3.02	3.24 / 3.41			
Inrush current		5	14.4			
Max. current		20	21			
Sound power level*1	Indoor*3	Cooling/Heating	63 / 63			
	Outdoor	Cooling/Heating	72 / 74			
Sound pressure level*1	Indoor*3	Cooling (Hi/Me/Lo/Ulo)	48 / 45 / 40 / 27			
		Heating (Hi/Me/Lo/Ulo)	48 / 43 / 38 / 30			
	Outdoor	Cooling/Heating	58 / 59			
			57 / 61			
Air flow	Indoor*3	Cooling (Hi/Me/Lo/Ulo)	24.5 / 21.3 / 17.6 / 10.4			
		Heating (Hi/Me/Lo/Ulo)	27.5 / 23.2 / 19.1 / 13.6			
	Outdoor	Cooling/Heating	135 / 135			
Exterior dimensions	Indoor	HeightxWidthxDepth	339 x 1,197 x 262			
	Outdoor		1,300 x 970 x 370			
Net weight	Indoor		16.5			
	Outdoor		115			
Ref.piping size	Liquid/Gas	ømm	9.52(3/8") / 22.22(7/8")			
Refrigerant line (one way) length		m	Max.70			
Vertical height differences		Outdoor is higher/lower	m	Max.30 / Max.15		
Outdoor operating temperature range	Cooling	°C	-15~50*2			
	Heating		-15~20			
Air filter, Q'ty			Polypropylene net x2 (Washable)			
Remote control (option)			wired:RC-EX3A, RC-E5, RCH-E3 & Interface kit:SC-BIKN2-E			

# FDE

## Indoor Unit Ceiling Suspended

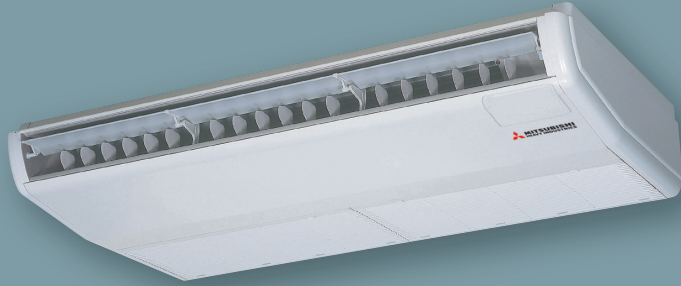

**New**

FDE 40/50/60/71/100/125/140



Energy Saving



Home Leave



Hi Power



Silent Operation



Flap Control



Favourite Setting



### Remote control (option)

#### Wired



RC-EX3A



RC-E5



RCH-E3

#### Wireless



RCN-E-E3

\*Not all functions available with all remote control options.

## High Efficiency

Energy efficiency was improved by use of DC fan motor & high efficient heat exchanger.

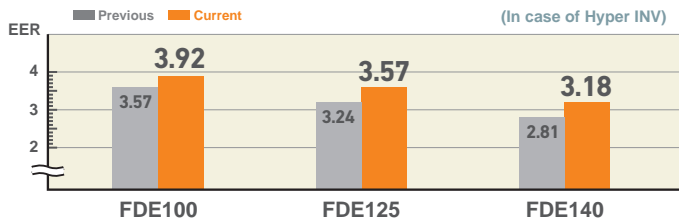

## Reduction of Weight

Thanks to decreasing the numbers of fan motor from two to one, reduction of weight was achieved.

	Previous	Current	
60VH-71VG	37	33	4kg less!!
100-125-140VG	49	43	6kg less!!

## Quieter Noise

The industry's lowest sound pressure levels were achieved by decreasing air flow volume, decreasing pressure loss with employment of one fan motor and optimizing casing and distributor shape.

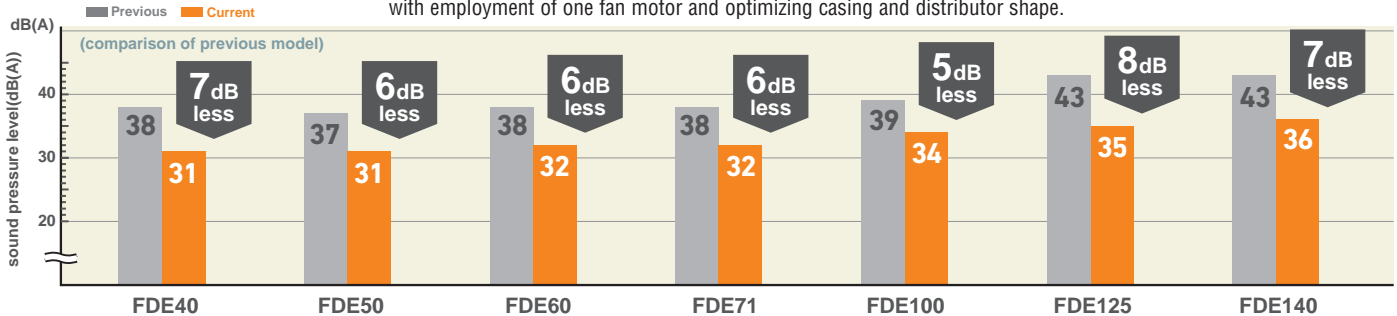

## Flap Control System

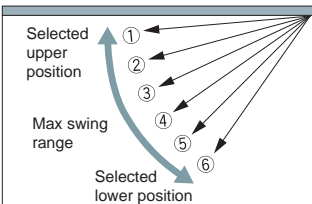

The flap can swing within the range of upper and lower flap position selected.

※The wireless remote control is not applicable to the flap control system.

## Motion Sensor (Option)

Motion sensor is equipped in the panel and detects the presence/absence and activity of humans in a room to improve the comfort and energy saving performance of the unit.



LB-E

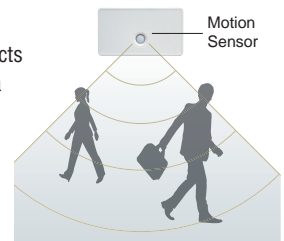

## Improved Installation Workability

The refrigerant pipe from the unit can be arranged in three directions, rear, right and up. The drain pipe can be arranged in two directions, left and right. This will allow a free layout of piping for various installation conditions. The unit can only be serviced from the bottom.

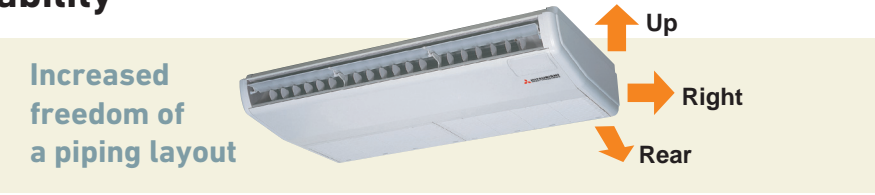

### OUTDOOR UNIT

	Hyper Inverter		Hyper Inverter	
SRC • FDC	40~60ZSX-W1	40~60ZSX-S	71VNX	100~140VN(S)X
model				
Chargeless	15m	15m	30m	
Height x Width x Depth (mm)	640 x 800(+71) x 290	640 x 800(+71) x 290	750 x 880(+88) x 340	1,300 x 970 x 370

	Micro Inverter			Standard Inverter		
FDC	100~140VN(S)A	200VSA	250VSA	71VNP	90VNP1	100VNP
model						
Chargeless	30m			15m		
Height x Width x Depth (mm)	845 x 970 x 370	1,300 x 970 x 370	1,505 x 970 x 370	640 x 800(+71) x 290	750 x 880(+88) x 340	845 x 970 x 370

### DIMENSIONS (Unit:mm) - FDE -

Models FDE40VH, 50VH

Symbol	Content
A	Gas piping $\phi 12.7 (1/2")$ (Flare)
B	Liquid piping $\phi 6.35 (1/4")$ (Flare)
C <sub>1,2</sub>	Drain piping VP20 (I.D.20, O.D.26)
D	Hole for suspension bolts (M10 or M8)
E	Back cutout PE cover
F	Top cutout Plate cover
G	Drain piping (for left back) (Knock out)

Note (1) The model name label is attached on the fan casing inside the air return grille.

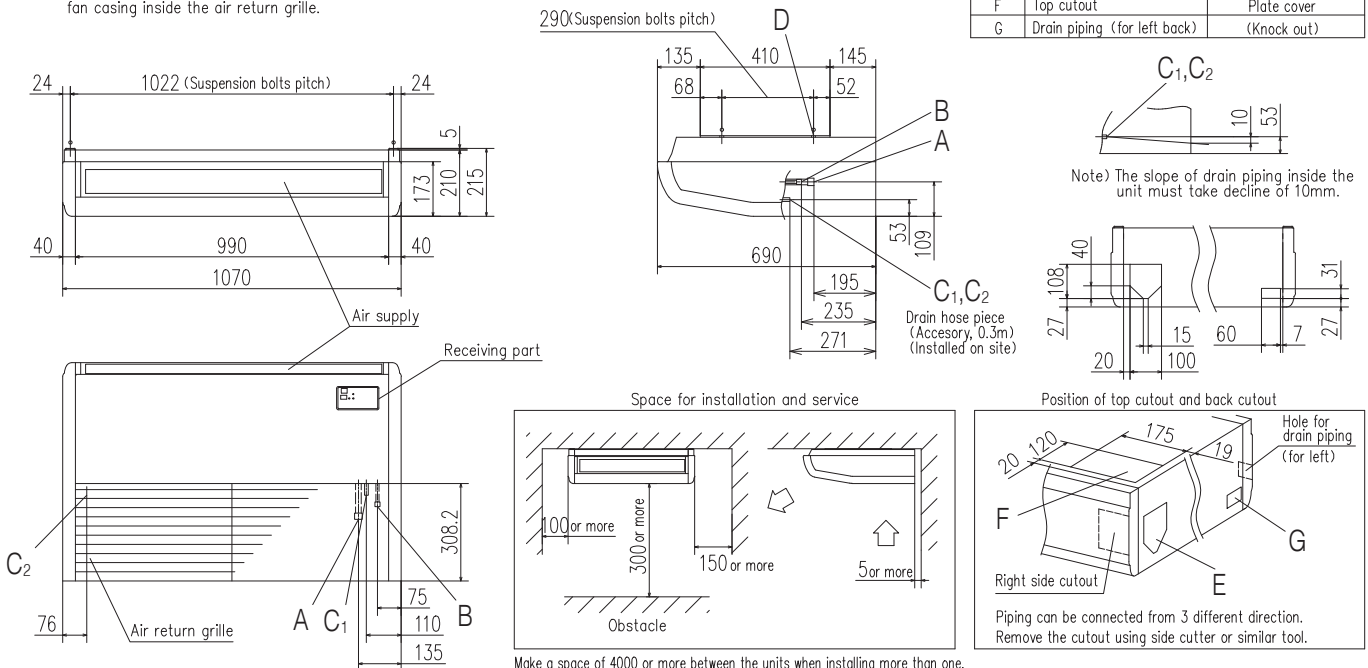



# DIMENSIONS (Unit:mm) - FDE -

## Models FDE60VH, 71VG

Note (1) The model name label is attached on the fan casing inside the air return grille.

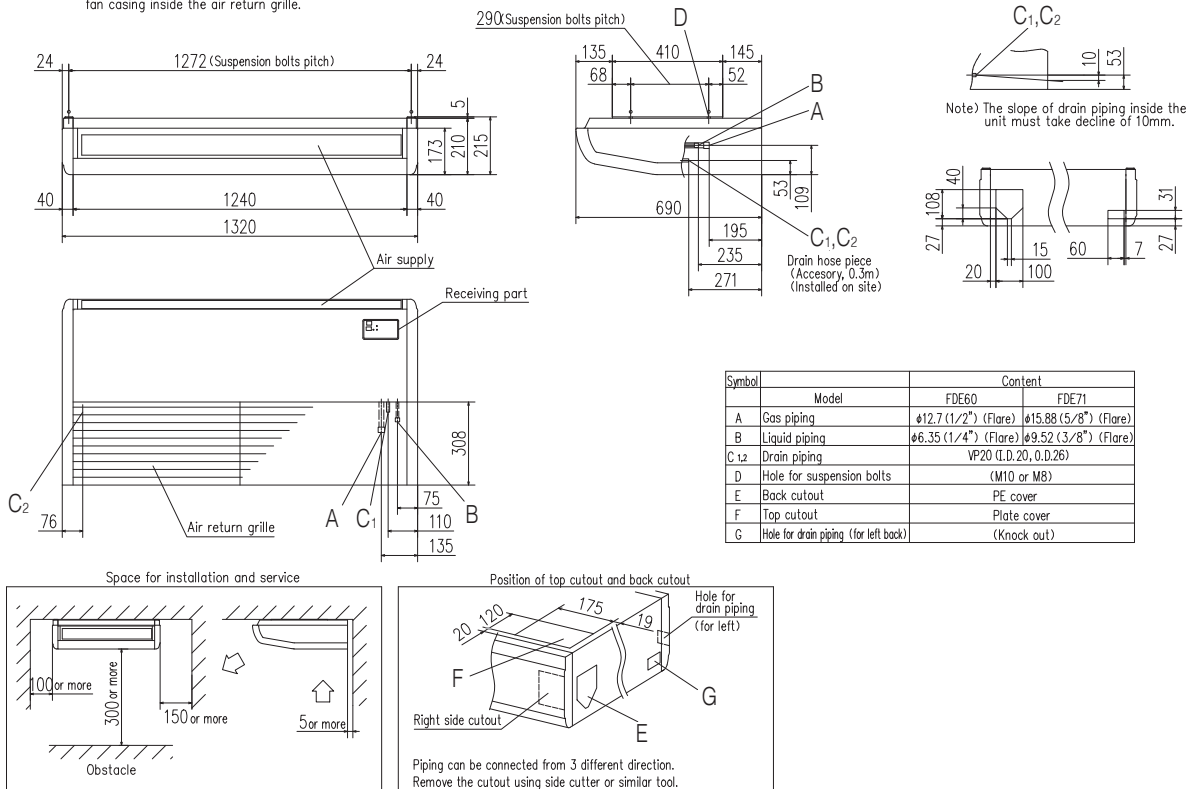

## Models FDE100VG, 125VG, 140VG

Note (1) The model name label is attached on the fan casing inside the air return grille.

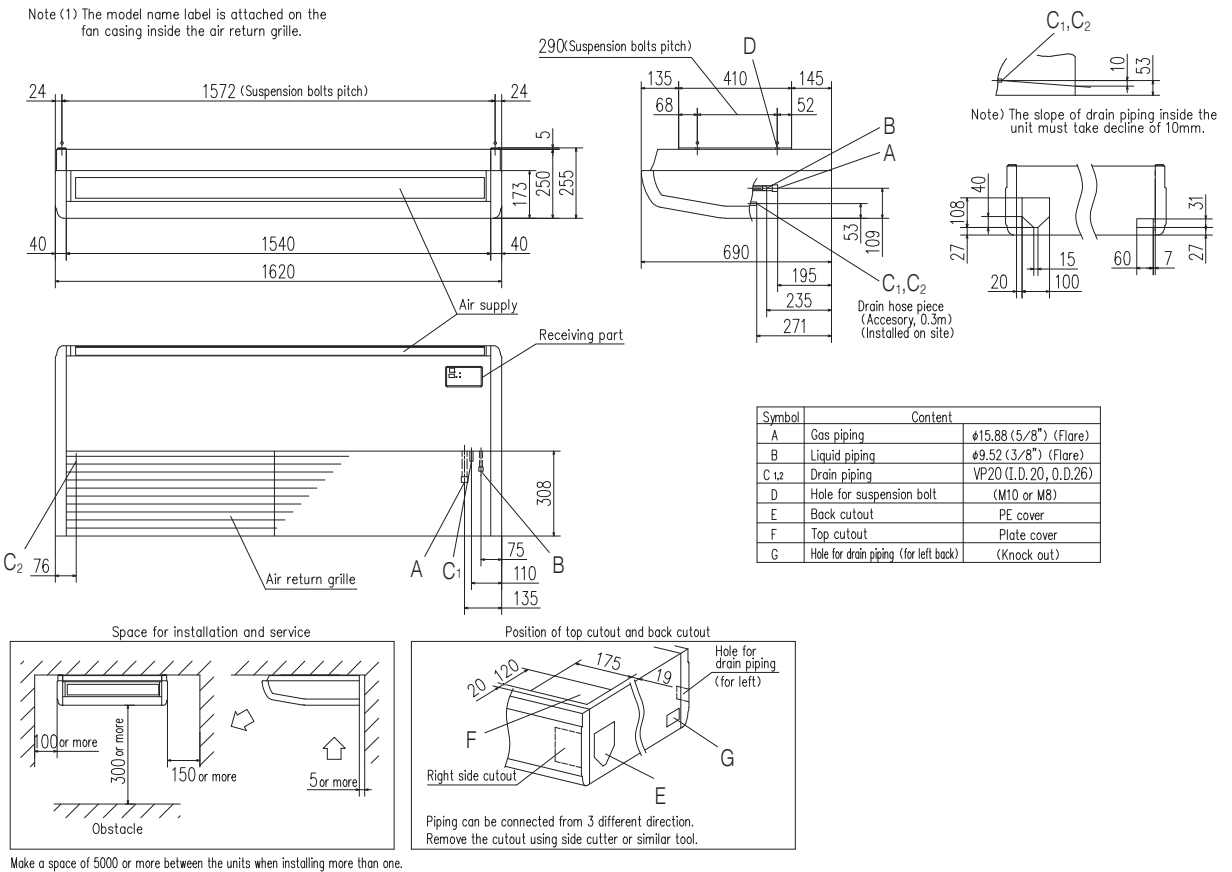

## SPECIFICATIONS - FDE -

R32		Hyper Inverter		
Set model name		FDE40ZSXW1VH	FDE50ZSXW1VH	FDE60ZSXW1VH
Indoor unit		FDE40VH	FDE50VH	FDE60VH
Outdoor unit		SRC40ZSX-W1	SRC50ZSX-W1	SRC60ZSX-W1
Power source		1 Phase 220-240V, 50Hz / 220V, 60Hz		
Nominal cooling capacity (Min~Max)		kW 4.0 ( 1.1 ~ 4.7 )	5.0 ( 1.1 ~ 5.6 )	5.6 ( 1.1 ~ 6.3 )
Nominal heating capacity (Min~Max)		kW 4.5 ( 0.6 ~ 5.4 )	5.4 ( 0.6 ~ 6.3 )	6.7 ( 0.6 ~ 7.1 )
Power consumption		Cooling/Heating kW 1.02 / 1.10	1.43 / 1.46	1.51 / 1.86
EER/COP		Cooling/Heating 3.92 / 4.09	3.49 / 3.70	3.71 / 3.60
Inrush current		A 5	5	5
Max. current		15	15	15
Sound power level*1	Indoor	Cooling/Heating	60 / 60	60 / 60
	Outdoor	Cooling/Heating	63 / 62	65 / 65
Sound pressure level*1	Indoor	Cooling (P-Hi/Hi/Me/Lo)	46 / 38 / 36 / 31	47 / 41 / 37 / 32
		Heating (P-Hi/Hi/Me/Lo)	46 / 38 / 36 / 31	47 / 41 / 37 / 32
	Outdoor	Cooling/Heating	52 / 50	53 / 54
		Cooling (P-Hi/Hi/Me/Lo)	13 / 10 / 9 / 7	13 / 10 / 9 / 7
Air flow	Indoor	Heating (P-Hi/Hi/Me/Lo)	13 / 10 / 9 / 7	20 / 16 / 13 / 10
		Cooling/Heating	39 / 30	41.5 / 39.0
	Outdoor	Cooling/Heating	39 / 30	41.5 / 39.0
Exterior dimensions	Indoor	HeightxWidthxDepth	210 x 1,070 x 690	
	Outdoor	HeightxWidthxDepth	640 x 800(+71) x 290	
Net weight	Indoor		28	33
	Outdoor		45	
Ref.piping size	Liquid/Gas		6.35(1/4") / 12.7(1/2")	
Refrigerant line (one way) length		m	Max.30	
Vertical height differences		Outdoor is higher/lower	Max.20 / Max.20	
Outdoor operating temperature range	Cooling	°C	-15~46*2	
	Heating		-20~24	
Air filter, Q'ty			Pocket Plastic net x2(Washable)	
Remote control (option)			wired:RC-EX3A, RC-E5, RCH-E3 wireless:RCN-E-E3	

### NOTES:

The data are measured under the following conditions(ISO-T1,H1).

Cooling:Indoor temp. of 27°CDB, 19°CWB, and outdoor temp. of 35°CDB. Heating:Indoor temp. of 20°CDB, and outdoor temp. of 7°CDB, 6°CWB.

\*1 : Indicates the value in an anechoic chamber. During operation these values are somewhat higher due to ambient conditions.

\*2 : If a cooling operation is conducted when the outdoor air temperature is -5°C or lower, the outdoor unit should be installed at a place where it is not influenced by natural wind. If wind blows, the low pressure will drop and compressor frequency will increase, this will cause the capacity to drop and may cause the unit to break down.

R410A		Hyper Inverter		
Set model name		FDE40ZSXVH	FDE50ZSXVH	FDE60ZSXVH
Indoor unit		FDE40VH	FDE50VH	FDE60VH
Outdoor unit		SRC40ZSX-S	SRC50ZSX-S	SRC60ZSX-S
Power source		1 Phase 220-240V, 50Hz / 220V, 60Hz		
Nominal cooling capacity (Min~Max)		kW 4.0 ( 1.1 ~ 4.7 )	5.0 ( 1.1 ~ 5.6 )	5.6 ( 1.1 ~ 6.3 )
Nominal heating capacity (Min~Max)		kW 4.5 ( 0.6 ~ 5.4 )	5.4 ( 0.6 ~ 6.3 )	6.7 ( 0.6 ~ 7.1 )
Power consumption		Cooling/Heating kW 1.02 / 1.10	1.52 / 1.46	1.75 / 1.86
EER/COP		Cooling/Heating 3.92 / 4.09	3.29 / 3.70	3.20 / 3.60
Inrush current		A 5	5	5
Max. current		12	15	15
Sound power level*1	Indoor	Cooling/Heating	60 / 60	60 / 60
	Outdoor	Cooling/Heating	63 / 63	65 / 64
Sound pressure level*1	Indoor	Cooling (P-Hi/Hi/Me/Lo)	46 / 38 / 36 / 31	47 / 41 / 37 / 32
		Heating (P-Hi/Hi/Me/Lo)	46 / 38 / 36 / 31	47 / 41 / 37 / 32
	Outdoor	Cooling/Heating	50 / 49	52 / 52
		Cooling (P-Hi/Hi/Me/Lo)	13 / 10 / 9 / 7	13 / 10 / 9 / 7
Air flow	Indoor	Heating (P-Hi/Hi/Me/Lo)	13 / 10 / 9 / 7	20 / 16 / 13 / 10
		Cooling/Heating	36 / 33	41.5 / 39
	Outdoor	Cooling/Heating	40 / 33	41.5 / 39
Exterior dimensions	Indoor	HeightxWidthxDepth	210 x 1,070 x 690	
	Outdoor	HeightxWidthxDepth	640 x 800(+71) x 290	
Net weight	Indoor		28	33
	Outdoor		45	
Ref.piping size	Liquid/Gas		6.35(1/4") / 12.7(1/2")	
Refrigerant line (one way) length		m	Max.30	
Vertical height differences		Outdoor is higher/lower	Max.20 / Max.20	
Outdoor operating temperature range	Cooling	°C	-15~46*2	
	Heating		-20~24	
Air filter, Q'ty			Pocket Plastic net x2(Washable)	
Remote control (option)			wired:RC-EX3A, RC-E5, RCH-E3 wireless:RCN-E-E3	

### NOTES:

The data are measured under the following conditions(ISO-T1).

Cooling:Indoor temp. of 27°CDB, 19°CWB, and outdoor temp. of 35°CDB. Heating:Indoor temp. of 20°CDB, and outdoor temp. of 7°CDB, 6°CWB.

\*1 : Indicates the value in an anechoic chamber. During operation these values are somewhat higher due to ambient conditions.

\*2 : If a cooling operation is conducted when the outdoor air temperature is -5°C or lower, the outdoor unit should be installed at a place where it is not influenced by natural wind. If wind blows, the low pressure will drop and compressor frequency will increase, this will cause the capacity to drop and may cause the unit to break down.

## SPECIFICATIONS - FDE -

R410A		Hyper Inverter	
Set model name		FDE71VNXVG	FDE100VNXVG
Indoor unit		FDE71VG	FDE100VG
Outdoor unit		FDC71VNX	FDC100VNX
Power source		1 Phase 220-240V, 50Hz / 220V, 60Hz	
Nominal cooling capacity (Min~Max)		kW 7.1 (3.2 ~ 8.0)	10.0 (4.0 ~ 11.2)
Nominal heating capacity (Min~Max)		kW 8.0 (3.6 ~ 9.0)	11.2 (4.0 ~ 12.5)
Power consumption		Cooling/Heating kW 2.11 / 2.11	2.55 / 2.68
EER/COP		Cooling/Heating 3.36 / 3.79	3.92 / 4.18
Inrush current		5	5
Max. current		17	24
Sound power level*1	Indoor	Cooling/Heating 60 / 60	64 / 64
	Outdoor	Cooling/Heating 66 / 66	70 / 70
Sound pressure level*1	Indoor	Cooling (P-Hi/Hi/Me/Lo) dB(A) 47 / 41 / 37 / 32	48 / 43 / 38 / 34
	Outdoor	Heating (P-Hi/Hi/Me/Lo) 47 / 41 / 37 / 32	48 / 43 / 38 / 34
Air flow	Indoor	Cooling (P-Hi/Hi/Me/Lo) m³/min 20 / 16 / 13 / 10	32 / 26 / 21 / 16.5
	Outdoor	Heating (P-Hi/Hi/Me/Lo) 20 / 16 / 13 / 10	32 / 26 / 21 / 16.5
Exterior dimensions	Indoor	HeightxWidthxDepth mm 210 x 1,320 x 690	250 x 1,620 x 690
	Outdoor	750 x 880(+88) x 340	1,300 x 970 x 370
Net weight	Indoor	33	43
	Outdoor	60	105
Ref.piping size		Liquid/Gas ømm 9.52(3/8") / 15.88(5/8")	
Refrigerant line (one way) length		m Max.50	Max.100
Vertical height differences		Outdoor is higher/lower m Max.30 / Max.15	
Outdoor operating temperature range		Cooling °C -15~43*2	
		Heating -20~20	
Air filter, Q'ty		Pocket Plastic net x2(Washable)	
Remote control (option)		wired:RC-EX3A, RC-E5, RCH-E3 wireless:RCN-E-E3	

R410A		Hyper Inverter				
Set model name		FDE125VNXVG	FDE140VNXVG	FDE100VSXVG	FDE125VSXVG	FDE140VSXVG
Indoor unit		FDE125VG	FDE140VG	FDE100VG	FDE125VG	FDE140VG
Outdoor unit		FDC125VNX	FDC140VNX	FDC100VSX	FDC125VSX	FDC140VSX
Power source		1 Phase 220-240V, 50Hz / 220V, 60Hz		3 Phase 380-415V, 50Hz / 380V, 60Hz		
Nominal cooling capacity (Min~Max)		kW 12.5 (5.0 ~ 14.0)	14.0 (5.0 ~ 16.0)	10.0 (4.0 ~ 11.2)	12.5 (5.0 ~ 14.0)	14.0 (5.0 ~ 16.0)
Nominal heating capacity (Min~Max)		kW 14.0 (4.0 ~ 17.0)	16.0 (4.0 ~ 18.0)	11.2 (4.0 ~ 16.0)	14.0 (4.0 ~ 18.0)	16.0 (4.0 ~ 20.0)
Power consumption		Cooling/Heating kW 3.50 / 3.77	4.40 / 4.69	2.55 / 2.68	3.50 / 3.77	4.40 / 4.69
EER/COP		Cooling/Heating 3.57 / 3.71	3.18 / 3.41	3.92 / 4.18	3.57 / 3.71	3.18 / 3.41
Inrush current		5	5	5	5	5
Max. current		26	26	15	15	15
Sound power level*1	Indoor	Cooling/Heating 64 / 64	65 / 65	64 / 64	64 / 64	65 / 65
	Outdoor	Cooling/Heating 70 / 70	72 / 72	70 / 70	70 / 70	72 / 72
Sound pressure level*1	Indoor	Cooling (P-Hi/Hi/Me/Lo) dB(A) 48 / 45 / 40 / 35	49 / 45 / 40 / 36	48 / 43 / 38 / 34	48 / 45 / 40 / 35	49 / 45 / 40 / 36
	Outdoor	Heating (P-Hi/Hi/Me/Lo) 48 / 45 / 40 / 35	49 / 45 / 40 / 36	48 / 43 / 38 / 34	48 / 45 / 40 / 35	49 / 45 / 40 / 36
Air flow	Indoor	Cooling (P-Hi/Hi/Me/Lo) m³/min 32 / 29 / 23 / 17	34 / 29 / 23 / 18	32 / 26 / 21 / 16.5	32 / 29 / 23 / 17	34 / 29 / 23 / 18
	Outdoor	Heating (P-Hi/Hi/Me/Lo) 32 / 29 / 23 / 17	34 / 29 / 23 / 18	32 / 26 / 21 / 16.5	32 / 29 / 23 / 17	34 / 29 / 23 / 18
Exterior dimensions	Indoor	HeightxWidthxDepth mm 100 / 100	100 / 100	100 / 100	100 / 100	100 / 100
	Outdoor	250 x 1,620 x 690	1,300 x 970 x 370			
Net weight	Indoor	43				
	Outdoor	105				
Ref.piping size		Liquid/Gas ømm 9.52(3/8") / 15.88(5/8")				
Refrigerant line (one way) length		m Max.100				
Vertical height differences		Outdoor is higher/lower m Max.30 / Max.15				
Outdoor operating temperature range		Cooling °C -15~43*2				
		Heating -20~20				
Air filter, Q'ty		Pocket Plastic net x2(Washable)				
Remote control (option)		wired:RC-EX3A, RC-E5, RCH-E3 wireless:RCN-E-E3				

### NOTES:

The data are measured under the following conditions(ISO-T1).  
 Cooling:Indoor temp. of 27°CDB, 19°CWB, and outdoor temp. of 35°CDB. Heating:Indoor temp. of 20°CDB, and outdoor temp. of 7°CDB, 6°CWB.  
 \*1 : Indicates the value in an anechoic chamber. During operation these values are somewhat higher due to ambient conditions.  
 \*2 : If a cooling operation is conducted when the outdoor air temperature is -5°C or lower, the outdoor unit should be installed at a place where it is not influenced by natural wind. If wind blows, the low pressure will drop and compressor frequency will increase, this will cause the capacity to drop and may cause the unit to break down.  
 \*3 : The values are for one indoor unit operation. (Multi system only)

The values are for simultaneous Multi operation.

R410A		Hyper Inverter				
Set model name		FDE71VNXPVH	FDE100VNXPVH	FDE125VNXPVH	FDE140VNXPGV	FDE140VNXTVH
		Twin			Triple	
Indoor unit		FDE40VH x 2	FDE50VH x 2	FDE60VH x 2	FDE71VG x 2	FDE50VH x 3
Outdoor unit		FDC71VNX	FDC100VNX	FDC125VNX	FDC140VNX	FDC140VNX
Power source		1 Phase 220-240V, 50Hz / 220V, 60Hz				
Nominal cooling capacity (Min~Max)	kW	7.1 (3.2 ~ 8.0)	10.0 (4.0 ~ 11.2)	12.5 (5.0 ~ 14.0)	14.0 (5.0 ~ 16.0)	14.0 (5.0 ~ 16.0)
Nominal heating capacity (Min~Max)	kW	8.0 (3.6 ~ 9.0)	11.2 (4.0 ~ 12.5)	14.0 (4.0 ~ 17.0)	16.0 (4.0 ~ 18.0)	16.0 (4.0 ~ 18.0)
Power consumption	Cooling/Heating	2.05 / 2.35	3.00 / 3.39	3.97 / 3.70	4.67 / 4.58	4.66 / 4.53
EER/COP	Cooling/Heating	3.46 / 3.40	3.33 / 3.30	3.15 / 3.78	3.00 / 3.49	3.00 / 3.53
Inrush current		5	5	5	5	5
Max. current		17	24	26	26	26
Sound power level*1	Indoor <sup>3</sup>	Cooling/Heating	60 / 60	60 / 60	60 / 60	60 / 60
	Outdoor	Cooling/Heating	66 / 66	70 / 70	70 / 70	72 / 72
Sound pressure level*1	Indoor <sup>3</sup>	Cooling (P-Hi/Hi/Me/Lo)	46 / 38 / 36 / 31	46 / 38 / 36 / 31	47 / 41 / 37 / 32	47 / 41 / 37 / 32
	Outdoor	Heating (P-Hi/Hi/Me/Lo)	46 / 38 / 36 / 31	46 / 38 / 36 / 31	47 / 41 / 37 / 32	47 / 41 / 37 / 32
Air flow	Indoor <sup>3</sup>	Cooling/Heating	51 / 48	48 / 50	48 / 50	49 / 52
	Outdoor	Cooling (P-Hi/Hi/Me/Lo)	13 / 10 / 9 / 7	13 / 10 / 9 / 7	20 / 16 / 13 / 10	20 / 16 / 13 / 10
Exterior dimensions	Indoor	HeightxWidthxDepth	210 x 1,070 x 690		210 x 1,320 x 690	
	Outdoor		750 x 880(+88) x 340		1,300 x 970 x 370	
Net weight	Indoor		28		33	
	Outdoor		60		105	
Ref.piping size	Liquid/Gas	ømm 9.52(3/8") / 15.88(5/8")				
Refrigerant line (one way) length		Max. 50		Max. 100		
Vertical height differences	Outdoor is higher/lower	Max.30 / Max.15				
Outdoor operating temperature range	Cooling	-15~43*2				
	Heating	-20~20				
Air filter, Q'ty		Pocket plastic net x 2(Washable)				
Remote control (option)		wired:RC-EX3A, RC-E5, RCH-E3 wireless:RCN-E-E3				

The values are for simultaneous Multi operation.

R410A		Hyper Inverter				
Set model name		FDE100VSXPVH	FDE125VSXPVH	FDE140VSXPVG	FDE140VSXTVH	
		Twin		Triple		
Indoor unit		FDE50VH x 2	FDE60VH x 2	FDE71VG x 2	FDE50VH x 3	
Outdoor unit		FDC100VSX	FDC125VSX	FDC140VSX	FDC140VSX	
Power source		3 Phase 380-415V, 50Hz / 380V, 60Hz				
Nominal cooling capacity (Min~Max)	kW	10.0 (4.0 ~ 11.2)	12.5 (5.0 ~ 14.0)	14.0 (5.0 ~ 16.0)	14.0 (5.0 ~ 16.0)	
Nominal heating capacity (Min~Max)	kW	11.2 (4.0 ~ 16.0)	14.0 (4.0 ~ 18.0)	16.0 (4.0 ~ 20.0)	16.0 (4.0 ~ 20.0)	
Power consumption	Cooling/Heating	3.00 / 3.39	3.97 / 3.70	4.67 / 4.58	4.66 / 4.53	
EER/COP	Cooling/Heating	3.33 / 3.30	3.15 / 3.78	3.00 / 3.49	3.00 / 3.53	
Inrush current		5	5	5	5	
Max. current		15	15	15	15	
Sound power level*1	Indoor <sup>3</sup>	Cooling/Heating	60 / 60	60 / 60	60 / 60	
	Outdoor	Cooling/Heating	70 / 70	70 / 70	72 / 72	
Sound pressure level*1	Indoor <sup>3</sup>	Cooling (P-Hi/Hi/Me/Lo)	46 / 38 / 36 / 31	47 / 41 / 37 / 32	47 / 41 / 37 / 32	
	Outdoor	Heating (P-Hi/Hi/Me/Lo)	46 / 38 / 36 / 31	47 / 41 / 37 / 32	47 / 41 / 37 / 32	
Air flow	Indoor <sup>3</sup>	Cooling/Heating	48 / 50	48 / 50	49 / 52	
	Outdoor	Cooling (P-Hi/Hi/Me/Lo)	13 / 10 / 9 / 7	20 / 16 / 13 / 10	20 / 16 / 13 / 10	
Exterior dimensions	Indoor	HeightxWidthxDepth	210 x 1,070 x 690		210 x 1,320 x 690	
	Outdoor		1,300 x 970 x 370		210 x 1,070 x 690	
Net weight	Indoor		28		33	
	Outdoor		105		28	
Ref.piping size	Liquid/Gas	ømm 9.52(3/8") / 15.88(5/8")				
Refrigerant line (one way) length		Max.100				
Vertical height differences	Outdoor is higher/lower	Max.30 / Max.15				
Outdoor operating temperature range	Cooling	-15~43*2				
	Heating	-20~20				
Air filter, Q'ty		Pocket plastic net x 2(Washable)				
Remote control (option)		wired:RC-EX3A, RC-E5, RCH-E3 wireless:RCN-E-E3				



## SPECIFICATIONS - FDE -

R410A			Micro Inverter		
Set model name			FDE100VNAV	FDE125VNAV	FDE140VNAV
Indoor unit			FDE100VG	FDE125VG	FDE140VG
Outdoor unit			FDC100VNA	FDC125VNA	FDC140VNA
Power source			1 Phase 220-240V, 50Hz / 220V, 60Hz		
Nominal cooling capacity (Min-Max)			10.0 (4.0 ~ 11.2)	12.5 (5.0 ~ 14.0)	13.6 (5.0 ~ 14.5)
Nominal heating capacity (Min-Max)			11.2 (4.0 ~ 12.5)	14.0 (4.0 ~ 16.0)	15.5 (4.0 ~ 16.5)
Power consumption			2.85 / 2.70	4.45 / 3.74	5.21 / 4.42
EER/COP			3.51 / 4.15	2.81 / 3.74	2.61 / 3.51
Inrush current			5	5	5
Max. current			24	24	24
Sound power level*1	Indoor	Cooling/Heating	64 / 64	64 / 64	65 / 65
	Outdoor	Cooling/Heating	70 / 70	71 / 71	73 / 73
Sound pressure level*1	Indoor	Cooling (P-Hi/Hi/Me/Lo)	48 / 43 / 38 / 34	48 / 45 / 40 / 35	49 / 45 / 40 / 36
		Heating (P-Hi/Hi/Me/Lo)	48 / 43 / 38 / 34	48 / 45 / 40 / 35	49 / 45 / 40 / 36
	Outdoor	Cooling/Heating	54 / 56	55 / 57	57 / 59
		Cooling (P-Hi/Hi/Me/Lo)	32 / 26 / 21 / 16.5	32 / 29 / 23 / 17	34 / 29 / 23 / 18
Air flow	Indoor	Heating (P-Hi/Hi/Me/Lo)	32 / 26 / 21 / 16.5	32 / 29 / 23 / 17	34 / 29 / 23 / 18
		Cooling/Heating	75 / 73	75 / 73	75 / 73
Exterior dimensions	Indoor	HeightxWidthxDepth	250 x 1,620 x 690		
	Outdoor	HeightxWidthxDepth	845 x 970 x 370		
Net weight	Indoor		43		
	Outdoor		80		
Ref.piping size	Liquid/Gas	ømm	9.52(3/8") / 15.88(5/8")		
Refrigerant line (one way) length			m		
Vertical height differences			Max.50		
Outdoor operating temperature range			Max.50 / Max.15		
			Cooling		
			-15~50*2		
			Heating		
			-20~20		
Air filter, Q'ty			Pocket Plastic net x2(Washable)		
Remote control (option)			wired:RC-EX3A, RC-E5, RCH-E3 wireless:RCN-E-E3		

R410A			Micro Inverter		
Set model name			FDE100VSAV	FDE125VSAV	FDE140VSAV
Indoor unit			FDE100VG	FDE125VG	FDE140VG
Outdoor unit			FDC100VSA	FDC125VSA	FDC140VSA
Power source			3 Phase 380-415V, 50Hz / 380V, 60Hz		
Nominal cooling capacity (Min-Max)			10.0 (4.0 ~ 11.2)	12.5 (5.0 ~ 14.0)	13.6 (5.0 ~ 14.5)
Nominal heating capacity (Min-Max)			11.2 (4.0 ~ 12.5)	14.0 (4.0 ~ 16.0)	15.5 (4.0 ~ 16.5)
Power consumption			2.85 / 2.70	4.45 / 3.74	5.21 / 4.42
EER/COP			3.51 / 4.15	2.81 / 3.74	2.61 / 3.51
Inrush current			5	5	5
Max. current			15	15	15
Sound power level*1	Indoor	Cooling/Heating	64 / 64	64 / 64	65 / 65
	Outdoor	Cooling/Heating	70 / 70	71 / 71	73 / 73
Sound pressure level*1	Indoor	Cooling (P-Hi/Hi/Me/Lo)	48 / 43 / 38 / 34	48 / 45 / 40 / 35	49 / 45 / 40 / 36
		Heating (P-Hi/Hi/Me/Lo)	48 / 43 / 38 / 34	48 / 45 / 40 / 35	49 / 45 / 40 / 36
	Outdoor	Cooling/Heating	54 / 56	55 / 57	57 / 59
		Cooling (P-Hi/Hi/Me/Lo)	32 / 26 / 21 / 16.5	32 / 29 / 23 / 17	34 / 29 / 23 / 18
Air flow	Indoor	Heating (P-Hi/Hi/Me/Lo)	32 / 26 / 21 / 16.5	32 / 29 / 23 / 17	34 / 29 / 23 / 18
		Cooling/Heating	75 / 73	75 / 73	75 / 73
Exterior dimensions	Indoor	HeightxWidthxDepth	250 x 1,620 x 690		
	Outdoor	HeightxWidthxDepth	845 x 970 x 370		
Net weight	Indoor		43		
	Outdoor		82		
Ref.piping size	Liquid/Gas	ømm	9.52(3/8") / 15.88(5/8")		
Refrigerant line (one way) length			m		
Vertical height differences			Max.50		
Outdoor operating temperature range			Max.50 / Max.15		
			Cooling		
			-15~50*2		
			Heating		
			-20~20		
Air filter, Q'ty			Pocket Plastic net x2(Washable)		
Remote control (option)			wired:RC-EX3A, RC-E5, RCH-E3 wireless:RCN-E-E3		

### NOTES:

The data are measured under the following conditions(ISO-T1).  
Cooling:Indoor temp. of 27°CDB, 19°CWB, and outdoor temp. of 35°CDB. Heating:Indoor temp. of 20°CDB, and outdoor temp. of 7°CDB, 6°CWB.  
\*1 : Indicates the value in an anechoic chamber. During operation these values are somewhat higher due to ambient conditions.  
\*2 : If a cooling operation is conducted when the outdoor air temperature is -5°C or lower, the outdoor unit should be installed at a place where it is not influenced by natural wind. If wind blows, the low pressure will drop and compressor frequency will increase, this will cause the capacity to drop and may cause the unit to break down.  
\*3 : The values are for one indoor unit operation. (Multi system only)

The values are for simultaneous Multi operation.

R410A		Micro Inverter		
Set model name		FDE100VNAPVH	FDE125VNAPVH	FDE140VNAPVG
		Twin		
Indoor unit		FDE50VH x 2	FDE60VH x 2	FDE71VG x 2
Outdoor unit		FDC100VNA	FDC125VNA	FDC140VNA
Power source		1 Phase 220-240V, 50Hz / 220V, 60Hz		
Nominal cooling capacity (Min~Max)	kW	10.0 ( 4.0 ~ 11.2 )	12.5 ( 5.0 ~ 14.0 )	13.6 ( 5.0 ~ 14.5 )
Nominal heating capacity (Min~Max)	kW	11.2 ( 4.0 ~ 12.5 )	14.0 ( 4.0 ~ 16.0 )	15.5 ( 4.0 ~ 16.5 )
Power consumption	Cooling/Heating kW	3.12 / 2.99	4.16 / 3.54	4.74 / 4.21
EER/COP	Cooling/Heating	3.21 / 3.75	3.00 / 3.95	2.87 / 3.68
Inrush current	A	5	5	5
Max. current		24	24	24
Sound power level*1	Indoor <sup>3</sup>	Cooling/Heating	60 / 60	60 / 60
	Outdoor	Cooling/Heating	70 / 70	73 / 73
Sound pressure level*1	Indoor <sup>3</sup>	Cooling (P-Hi/Hi/Me/Lo)	46 / 38 / 36 / 31	47 / 41 / 37 / 32
		Heating (P-Hi/Hi/Me/Lo)	46 / 38 / 36 / 31	47 / 41 / 37 / 32
	Outdoor	Cooling/Heating	54 / 56	55 / 57
Air flow	Indoor <sup>3</sup>	Cooling (P-Hi/Hi/Me/Lo)	13 / 10 / 9 / 7	20 / 16 / 13 / 10
		Heating (P-Hi/Hi/Me/Lo)	13 / 10 / 9 / 7	20 / 16 / 13 / 10
	Outdoor	Cooling/Heating	75 / 73	75 / 73
Exterior dimensions	Indoor	HeightxWidthxDepth	210 x 1,070 x 690	
	Outdoor		210 x 1,320 x 690	
Net weight	Indoor		28	33
	Outdoor		80	
Ref.piping size	Liquid/Gas		9.52(3/8") / 15.88(5/8")	
Refrigerant line (one way) length			Max. 50	
Vertical height differences	Outdoor is higher/lower		Max.50 / Max.15	
Outdoor operating temperature range	Cooling		-15~50*2	
	Heating		-20~20	
Air filter, Q'ty			Pocket plastic net x 2(Washable)	
Remote control (option)			wired:RC-EX3A, RC-E5, RCH-E3 wireless:RCN-E-E3	

The values are for simultaneous Multi operation.

R410A		Micro Inverter		
Set model name		FDE140VNATVH	FDE100VSAPVH	FDE125VSAPVH
		Triple	Twin	
Indoor unit		FDE50VH x 3	FDE50VH x 2	FDE60VH x 2
Outdoor unit		FDC140VNA	FDC100VSA	FDC125VSA
Power source		1 Phase 220-240V, 50Hz / 220V, 60Hz	3 Phase 380-415V, 50Hz / 380V, 60Hz	
Nominal cooling capacity (Min~Max)	kW	13.6 ( 5.0 ~ 14.5 )	10.0 ( 4.0 ~ 11.2 )	12.5 ( 5.0 ~ 14.0 )
Nominal heating capacity (Min~Max)	kW	15.5 ( 4.0 ~ 16.5 )	11.2 ( 4.0 ~ 12.5 )	14.0 ( 4.0 ~ 16.0 )
Power consumption	Cooling/Heating kW	4.74 / 4.21	3.12 / 2.99	4.16 / 3.54
EER/COP	Cooling/Heating	2.87 / 3.68	3.21 / 3.75	3.00 / 3.95
Inrush current	A	5	5	5
Max. current		24	15	15
Sound power level*1	Indoor <sup>3</sup>	Cooling/Heating	60 / 60	60 / 60
	Outdoor	Cooling/Heating	73 / 73	71 / 71
Sound pressure level*1	Indoor <sup>3</sup>	Cooling (P-Hi/Hi/Me/Lo)	46 / 38 / 36 / 31	47 / 41 / 37 / 32
		Heating (P-Hi/Hi/Me/Lo)	46 / 38 / 36 / 31	47 / 41 / 37 / 32
	Outdoor	Cooling/Heating	57 / 59	54 / 56
Air flow	Indoor <sup>3</sup>	Cooling (P-Hi/Hi/Me/Lo)	13 / 10 / 9 / 7	20 / 16 / 13 / 10
		Heating (P-Hi/Hi/Me/Lo)	13 / 10 / 9 / 7	20 / 16 / 13 / 10
	Outdoor	Cooling/Heating	75 / 73	75 / 73
Exterior dimensions	Indoor	HeightxWidthxDepth	210 x 1,070 x 690	
	Outdoor		210 x 1,320 x 690	
Net weight	Indoor		28	33
	Outdoor		80	82
Ref.piping size	Liquid/Gas		9.52(3/8") / 15.88(5/8")	
Refrigerant line (one way) length			Max. 50	
Vertical height differences	Outdoor is higher/lower		Max.50 / Max.15	
Outdoor operating temperature range	Cooling		-15~50*2	
	Heating		-20~20	
Air filter, Q'ty			Pocket plastic net x 2(Washable)	
Remote control (option)			wired:RC-EX3A, RC-E5, RCH-E3 wireless:RCN-E-E3	

## SPECIFICATIONS - FDE -

The values are for simultaneous Multi operation.

R410A		Micro Inverter		
Set model name		FDE140VSAPVG	FDE200VSAPVG	FDE250VSAPVG
		Twin		
Indoor unit		FDE71VG x 2	FDE100VG x 2	FDE125VG x 2
Outdoor unit		FDC140VSA	FDC200VSA	FDC250VSA
Power source		3 Phase 380-415V, 50Hz / 380V, 60Hz		
Nominal cooling capacity (Min~Max)	kW	13.6 (5.0 ~ 14.5)	19.0 (5.2 ~ 22.4)	24.0 (6.9 ~ 28.0)
Nominal heating capacity (Min~Max)	kW	15.5 (4.0 ~ 16.5)	22.4 (3.3 ~ 25.0)	27.0 (5.5 ~ 31.5)
Power consumption	Cooling/Heating	4.74 / 4.21	6.34 / 6.10	8.52 / 7.54
EER/COP	Cooling/Heating	2.87 / 3.68	3.00 / 3.67	2.82 / 3.58
Inrush current		5	5	5
Max. current		15	20	21
Sound power level*1	Indoor <sup>3</sup>	Cooling/Heating	60 / 60	64 / 64
	Outdoor	Cooling/Heating	73 / 73	72 / 74
Sound pressure level*1	Indoor <sup>3</sup>	Cooling (P-Hi/Hi/Me/Lo)	47 / 41 / 37 / 32	48 / 43 / 38 / 34
	Outdoor	Heating (P-Hi/Hi/Me/Lo)	47 / 41 / 37 / 32	48 / 43 / 38 / 34
Air flow	Indoor <sup>3</sup>	Cooling/Heating	57 / 59	58 / 59
	Outdoor	Cooling/Heating	20 / 16 / 13 / 10	32 / 26 / 21 / 16.5
Exterior dimensions	Indoor	HeightxWidthxDepth	210 x 1,320 x 690	250 x 1,620 x 690
	Outdoor	HeightxWidthxDepth	845 x 970 x 370	1,300 x 970 x 370
Net weight	Indoor		33	43
	Outdoor		82	143
Ref.piping size	Liquid/Gas	ømm	9.52(3/8") / 15.88(5/8")	9.52(3/8") / 22.22(7/8")
Refrigerant line (one way) length		m	Max.50	Max.70
Vertical height differences	Outdoor is higher/lower	m	Max.50 / Max.15	Max.30 / Max.15
Outdoor operating temperature range	Cooling	°C	-15~50*2	
	Heating	°C	-20~20	-15~20
Air filter, Q'ty			Pocket plastic net x 2(Washable)	
Remote control (option)			wired:RC-EX3A, RC-E5, RCH-E3 wireless:RCN-E-E3	

The values are for simultaneous Multi operation.

R410A		Micro Inverter		
Set model name		FDE140VSATVH	FDE200VSATVG	
		Triple		
Indoor unit		FDE50VH x 3	FDE71VG x 3	
Outdoor unit		FDC140VSA	FDC200VSA	
Power source		3 Phase 380-415V, 50Hz / 380V, 60Hz		
Nominal cooling capacity (Min~Max)	kW	13.6 (5.0 ~ 14.5)	19.0 (5.2 ~ 22.4)	
Nominal heating capacity (Min~Max)	kW	15.5 (4.0 ~ 16.5)	22.4 (3.3 ~ 25.0)	
Power consumption	Cooling/Heating	4.74 / 4.21	6.33 / 5.94	
EER/COP	Cooling/Heating	2.87 / 3.68	3.00 / 3.77	
Inrush current		5	5	
Max. current		15	20	
Sound power level*1	Indoor <sup>3</sup>	Cooling/Heating	60 / 60	60 / 60
	Outdoor	Cooling/Heating	73 / 73	72 / 74
Sound pressure level*1	Indoor <sup>3</sup>	Cooling (P-Hi/Hi/Me/Lo)	46 / 38 / 36 / 31	47 / 41 / 37 / 32
	Outdoor	Heating (P-Hi/Hi/Me/Lo)	46 / 38 / 36 / 31	47 / 41 / 37 / 32
Air flow	Indoor <sup>3</sup>	Cooling/Heating	57 / 59	58 / 59
	Outdoor	Cooling/Heating	13 / 10 / 9 / 7	20 / 16 / 13 / 10
Exterior dimensions	Indoor	HeightxWidthxDepth	210 x 1,070 x 690	210 x 1,320 x 690
	Outdoor	HeightxWidthxDepth	845 x 970 x 370	1,300 x 970 x 370
Net weight	Indoor		28	33
	Outdoor		82	115
Ref.piping size	Liquid/Gas	ømm	9.52(3/8") / 15.88(5/8")	9.52(3/8") / 22.22(7/8")
Refrigerant line (one way) length		m	Max.50	Max.70
Vertical height differences	Outdoor is higher/lower	m	Max.50 / Max.15	Max.30 / Max.15
Outdoor operating temperature range	Cooling	°C	-15~50*2	
	Heating	°C	-20~20	-15~20
Air filter, Q'ty			Pocket plastic net x 2(Washable)	
Remote control (option)			wired:RC-EX3A, RC-E5, RCH-E3 wireless:RCN-E-E3	

### NOTES:

The data are measured under the following conditions(ISO-T1).

Cooling:Indoor temp. of 27°CDB, 19°CWB, and outdoor temp. of 35°CDB. Heating:Indoor temp. of 20°CDB, and outdoor temp. of 7°CDB, 6°CWB.

\*1 : Indicates the value in an anechoic chamber. During operation these values are somewhat higher due to ambient conditions.

\*2 : If a cooling operation is conducted when the outdoor air temperature is -5°C or lower, the outdoor unit should be installed at a place where it is not influenced by natural wind. If wind blows, the low pressure will drop and compressor frequency will increase, this will cause the capacity to drop and may cause the unit to break down.

\*3 : The values are for one indoor unit operation. (Multi system only)

The values are for simultaneous Multi operation.

R410A			Micro Inverter			
Set model name			FDE200VSADVH	FDE250VSADVH		
			Double Twin			
Indoor unit			FDE50VH x 4		FDE60VH x 4	
Outdoor unit			FDC200VSA		FDC250VSA	
Power source			3 Phase 380-415V, 50Hz / 380V, 60Hz			
Nominal cooling capacity (Min~Max)		kW	19.0 ( 5.2 ~ 22.4 )		24.0 ( 6.9 ~ 28.0 )	
Nominal heating capacity (Min~Max)		kW	22.4 ( 3.3 ~ 25.0 )		27.0 ( 5.5 ~ 31.5 )	
Power consumption	Cooling/Heating	kW	6.90 / 7.10		8.00 / 7.02	
EER/COP	Cooling/Heating		2.75 / 3.15		3.00 / 3.85	
Inrush current		A	5		5	
Max. current			20		21	
Sound power level*1	Indoor <sup>3</sup>	Cooling/Heating	60 / 60		60 / 60	
	Outdoor	Cooling/Heating	72 / 74		73 / 75	
Sound pressure level*1	Indoor <sup>3</sup>	Cooling (P-Hi/Hi/Me/Lo)	46 / 38 / 36 / 31		47 / 41 / 37 / 32	
		Heating (P-Hi/Hi/Me/Lo)	46 / 38 / 36 / 31		47 / 41 / 37 / 32	
	Outdoor	Cooling/Heating	58 / 59		59 / 62	
Air flow	Indoor <sup>3</sup>	Cooling (P-Hi/Hi/Me/Lo)	13 / 10 / 9 / 7		20 / 16 / 13 / 10	
		Heating (P-Hi/Hi/Me/Lo)	13 / 10 / 9 / 7		20 / 16 / 13 / 10	
	Outdoor	Cooling/Heating	135 / 135		143 / 151	
Exterior dimensions	Indoor	HeightxWidthxDepth	mm	210 x 1,070 x 690		
	Outdoor			1,300 x 970 x 370		
Net weight	Indoor		kg	28		
	Outdoor			115		
Ref.piping size	Liquid/Gas	ømm	9.52(3/8") / 22.22(7/8")		12.7(1/2") / 22.22(7/8")	
Refrigerant line (one way) length			Max.70			
Vertical height differences Outdoor is higher/lower			Max.30 / Max.15			
Outdoor operating temperature range			Cooling			-15~50*2
			Heating			-15~20
Air filter, Q'ty			Pocket plastic net x 2(Washable)			
Remote control (option)			wired:RC-EX3A, RC-E5, RCH-E3 wireless:RCN-E-E3			

R410A			Standard Inverter			
Set model name			FDE71VNPVG	FDE90VNP1VG	FDE100VNP1VG	
			Indoor unit			FDE71VG
Outdoor unit			FDC71VNP	FDC90VNP1	FDC100VNP	
Power source			1 Phase 220-240V, 50Hz / 220V, 60Hz			
Nominal cooling capacity (Min~Max)		kW	7.1 ( 1.4 ~ 7.1 )	9.0 ( 1.9 ~ 9.0 )	10.0 ( 2.8 ~ 11.2 )	
Nominal heating capacity (Min~Max)		kW	7.1 ( 1.0 ~ 7.1 )	9.0 ( 1.5 ~ 9.0 )	11.2 ( 2.5 ~ 12.5 )	
Power consumption	Cooling/Heating	kW	2.50 / 1.96	2.75 / 2.22	2.66 / 2.94	
EER/COP	Cooling/Heating		2.84 / 3.62	3.27 / 4.05	3.76 / 3.81	
Inrush current		A	5		5	
Max. current			14.5		18.0	
Sound power level*1	Indoor	Cooling/Heating	60 / 60		64 / 64	
	Outdoor	Cooling/Heating	67 / 67		70 / 70	
Sound pressure level*1	Indoor	Cooling (P-Hi/Hi/Me/Lo)	47 / 41 / 37 / 32		48 / 43 / 38 / 34	
		Heating (P-Hi/Hi/Me/Lo)	47 / 41 / 37 / 32		48 / 43 / 38 / 34	
	Outdoor	Cooling/Heating	54 / 54		57 / 55	
Air flow	Indoor	Cooling (P-Hi/Hi/Me/Lo)	20 / 16 / 13 / 10		32 / 26 / 21 / 16.5	
		Heating (P-Hi/Hi/Me/Lo)	20 / 16 / 13 / 10		32 / 26 / 21 / 16.5	
	Outdoor	Cooling/Heating	36 / 36		63 / 49.5	
Exterior dimensions	Indoor	HeightxWidthxDepth	mm	210 x 1,320 x 690		
	Outdoor			640 x 800(+71) x 290		
Net weight	Indoor		kg	33		
	Outdoor			45		
Ref.piping size	Liquid/Gas	ømm	6.35(1/4") / 12.7(1/2")		6.35(1/4") / 15.88(5/8")	
Refrigerant line (one way) length			Max.30			
Vertical height differences Outdoor is higher/lower			Max.20 / Max.20			
Outdoor operating temperature range			Cooling			-15~46*2
			Heating			-15~20
Air filter, Q'ty			Pocket Plastic net x2(Washable)			
Remote control (option)			wired:RC-EX3A, RC-E5, RCH-E3 wireless:RCN-E-E3			



# FDF

## Indoor Unit Floor Standing



FDF 71/100/125/140

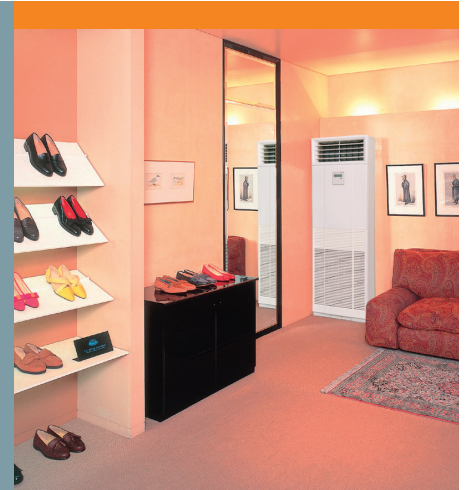

- Set Temperature Auto Return\*
- Vertical Auto Swing
- Automatic Operation
- Weekly Timer
- Filter Sign
- Self-Diagnostics



### Remote control (option)

#### Wireless



RCN-KIT4-E2

\*Not all functions available with all remote control options.

## Wide and Powerful Air Flow

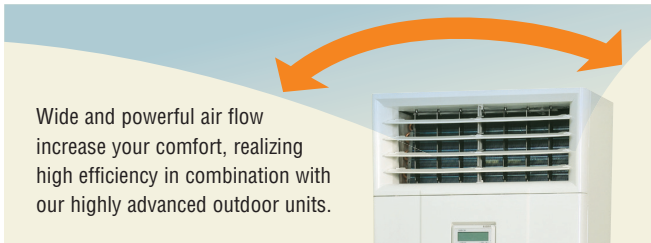

## Easy Transportation and Installation Workability

Piping and drain hose connection can be selected out of 4-directions and the selection makes installation workability more effective. Due to slim design (Depth: 320mm), easy transportation and installation are realized.

### Easy Maintenance

The surface of heat exchanger can be appeared only removing the front panel. Easy cleaning of heat exchanger is possible.

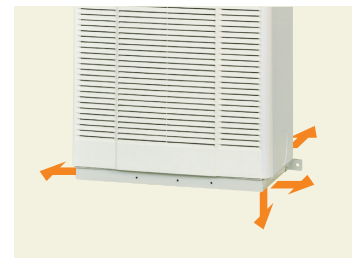

## OUTDOOR UNIT

FDC	Hyper Inverter	
	71VNX	100~140VN(S)X
model		
Chargeless	30m	
Height x Width x Depth (mm)	750 x 880(+88) x 340	1,300 x 970 x 370

FDC	Micro Inverter			Standard Inverter		
	100~140VN(S)A	200VSA	250VSA	71VNP	90VNP1	100VNP
model						
Chargeless	30m			15m		
Height x Width x Depth (mm)	845 x 970 x 370	1,300 x 970 x 370	1,505 x 970 x 370	640 x 800(+71) x 290	750 x 880(+88) x 340	845 x 970 x 370

**DIMENSIONS (Unit:mm) - FDF -**

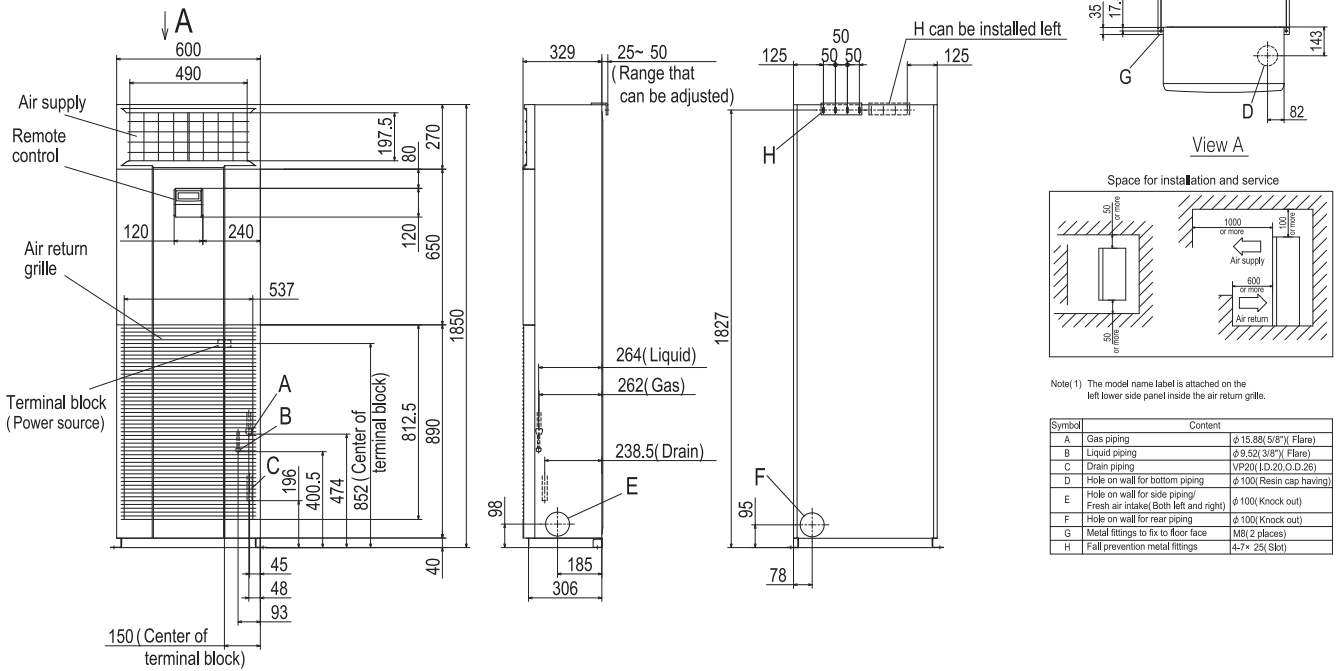

**SPECIFICATIONS - FDF -**

R410A		Hyper Inverter				
Set model name		fdf71vnxvd1	fdf100vnxvd2	fdf125vnxvd	fdf140vnxvd	
Indoor unit		fdf71vd1	fdf100vd2	fdf125vd	fdf140vd	
Outdoor unit		fdc71vnx	fdc100vnx	fdc125vnx	fdc140vnx	
Power source		1 Phase 220-240V, 50Hz / 220V, 60Hz				
Nominal cooling capacity (Min~Max)		kW 7.1 (3.2 ~ 8.0)	10.0 (4.0 ~ 11.2)	12.5 (5.0 ~ 14.0)	14.0 (5.0 ~ 16.0)	
Nominal heating capacity (Min~Max)		kW 8.0 (3.6 ~ 9.0)	11.2 (4.0 ~ 12.5)	14.0 (4.0 ~ 17.0)	16.0 (4.0 ~ 18.0)	
Power consumption	Cooling/Heating	kW 2.21 / 2.21	2.83 / 3.04	3.89 / 3.88	4.65 / 4.69	
EER/COP	Cooling/Heating	3.21 / 3.62	3.53 / 3.68	3.21 / 3.61	3.01 / 3.41	
Inrush current	A	5	5	5	5	
Max. current		17	24	26	26	
Sound power level*1	Indoor	Cooling/Heating	61 / 61	65 / 65	73 / 73	73 / 73
	Outdoor	Cooling/Heating	66 / 66	70 / 70	70 / 70	72 / 72
Sound pressure level*1	Indoor	Cooling (P-Hi/Hi/Me/Lo)	42 / 39 / 35 / 33	54 / 50 / 48 / 44	54 / 50 / 48 / 44	54 / 50 / 48 / 44
		Heating (P-Hi/Hi/Me/Lo)	42 / 39 / 35 / 33	54 / 50 / 48 / 44	54 / 50 / 48 / 44	54 / 50 / 48 / 44
Air flow	Indoor	Cooling/Heating	51 / 48	48 / 50	48 / 50	49 / 52
		Cooling (P-Hi/Hi/Me/Lo)	20 / 18 / 16 / 14	29 / 26 / 23 / 19	29 / 26 / 23 / 19	29 / 26 / 23 / 19
Air flow	Outdoor	Heating (P-Hi/Hi/Me/Lo)	20 / 18 / 16 / 14	29 / 26 / 23 / 19	29 / 26 / 23 / 19	29 / 26 / 23 / 19
		Cooling/Heating	60 / 50	100 / 100	100 / 100	100 / 100
Exterior dimensions	Indoor	HeightxWidthxDPTH	mm 1,850 x 600 x 320			
	Outdoor		750 x 880(+88) x 340	1,300 x 970 x 370		
Net weight	Indoor	kg	49	52		
	Outdoor		60	105		
Ref.piping size	Liquid/Gas	ømm	9.52(3/8") / 15.88(5/8")			
Refrigerant line (one way) length		m	Max.50	Max.100		
Vertical height differences	Outdoor is higher/lower	m	Max.30 / Max.15			
Outdoor operating temperature range	Cooling	°C	-15~43*2			
	Heating	°C	-20~20			
Air filter, Q'ty			Plastic net x 1(washable)			
Remote control			wired:RC-E5 (installed) wireless:RCN-KIT4-E2 (option)			

NOTES:

The data are measured under the following conditions(ISO-T1).  
 Cooling:Indoor temp. of 27°CDB, 19°CWB, and outdoor temp. of 35°CDB. Heating:Indoor temp. of 20°CDB, and outdoor temp. of 7°CDB, 6°CWB.  
 \*1 : Indicates the value in an anechoic chamber. During operation these values are somewhat higher due to ambient conditions.  
 \*2 : If a cooling operation is conducted when the outdoor air temperature is -5°C or lower, the outdoor unit should be installed at a place where it is not influenced by natural wind. If wind blows, the low pressure will drop and compressor frequency will increase, this will cause the capacity to drop and may cause the unit to break down.

## SPECIFICATIONS - FDF -

R410A		Hyper Inverter		
Set model name		FDF100VSXVD2	FDF125VSXVD	FDF140VSXVD
Indoor unit		FDF100VD2	FDF125VD	FDF140VD
Outdoor unit		FDC100VSX	FDC125VSX	FDC140VSX
Power source		3 Phase 380-415V, 50Hz / 380V, 60Hz		
Nominal cooling capacity (Min~Max)	kW	10.0 ( 4.0 ~ 11.2 )	12.5 ( 5.0 ~ 14.0 )	14.0 ( 5.0 ~ 16.0 )
Nominal heating capacity (Min~Max)	kW	11.2 ( 4.0 ~ 16.0 )	14.0 ( 4.0 ~ 18.0 )	16.0 ( 4.0 ~ 20.0 )
Power consumption	Cooling/Heating	2.83 / 3.04	3.89 / 3.88	4.65 / 4.69
EER/COP	Cooling/Heating	3.53 / 3.68	3.21 / 3.61	3.01 / 3.41
Inrush current		5	5	5
Max. current		15	15	15
Sound power level*1	Indoor	Cooling/Heating	65 / 65	73 / 73
	Outdoor	Cooling/Heating	70 / 70	72 / 72
Sound pressure level*1	Indoor	Cooling (P-Hi/Hi/Me/Lo)	54 / 50 / 48 / 44	54 / 50 / 48 / 44
		Heating (P-Hi/Hi/Me/Lo)	54 / 50 / 48 / 44	54 / 50 / 48 / 44
	Outdoor	Cooling/Heating	48 / 50	49 / 52
Air flow	Indoor	Cooling (P-Hi/Hi/Me/Lo)	29 / 26 / 23 / 19	29 / 26 / 23 / 19
		Heating (P-Hi/Hi/Me/Lo)	29 / 26 / 23 / 19	29 / 26 / 23 / 19
	Outdoor	Cooling/Heating	100 / 100	100 / 100
Exterior dimensions	Indoor	HeightxWidthxDepth	1,850 x 600 x 320	
	Outdoor		1,300 x 970 x 370	
Net weight	Indoor		52	
	Outdoor		105	
Ref.piping size	Liquid/Gas	ømm	9.52(3/8") / 15.88(5/8")	
Refrigerant line (one way) length		m	Max.100	
Vertical height differences	Outdoor is higher/lower	m	Max.30 / Max.15	
Outdoor operating temperature range	Cooling	°C	-15~43*2	
	Heating		-20~20	
Air filter, Q'ty			Plastic net x 1(washable)	
Remote control			wired:RC-E5 (installed) wireless:RCN-KIT4-E2 (option)	

The values are for simultaneous Multi operation.

R410A		Hyper Inverter		
Set model name		FDF140VNXPD1	Twin	FDF140VSXPVD1
Indoor unit		FDF71VD1 x 2		FDF71VD1 x 2
Outdoor unit		FDC140VNX		FDC140VSX
Power source		1 Phase 220-240V, 50Hz / 220V, 60Hz		3 Phase 380-415V, 50Hz / 380V 60Hz
Nominal cooling capacity (Min~Max)	kW	14.0 ( 5.0 ~ 16.0 )		14.0 ( 5.0 ~ 16.0 )
Nominal heating capacity (Min~Max)	kW	16.0 ( 4.0 ~ 18.0 )		16.0 ( 4.0 ~ 20.0 )
Power consumption	Cooling/Heating	4.83 / 4.97		4.83 / 4.97
EER/COP	Cooling/Heating	2.90 / 3.22		2.90 / 3.22
Inrush current		5		5
Max. current		26		15
Sound power level*1	Indoor*3	Cooling/Heating	61 / 61	61 / 61
	Outdoor	Cooling/Heating	72 / 72	72 / 72
Sound pressure level*1	Indoor*3	Cooling (P-Hi/Hi/Me/Lo)	42 / 39 / 35 / 33	42 / 39 / 35 / 33
		Heating (P-Hi/Hi/Me/Lo)	42 / 39 / 35 / 33	42 / 39 / 35 / 33
	Outdoor	Cooling/Heating	49 / 52	49 / 52
Air flow	Indoor*3	Cooling (P-Hi/Hi/Me/Lo)	18 / 16 / 14 / 12	18 / 16 / 14 / 12
		Heating (P-Hi/Hi/Me/Lo)	18 / 16 / 14 / 12	18 / 16 / 14 / 12
	Outdoor	Cooling/Heating	100 / 100	100 / 100
Exterior dimensions	Indoor	HeightxWidthxDepth	1,850 x 600 x 320	
	Outdoor		1,300 x 970 x 370	
Net weight	Indoor		49	
	Outdoor		105	
Ref.piping size	Liquid/Gas	ømm	9.52(3/8") / 15.88(5/8")	
Refrigerant line (one way) length		m	Max.100	
Vertical height differences	Outdoor is higher/lower	m	Max.30 / Max.15	
Outdoor operating temperature range	Cooling	°C	-15~43*2	
	Heating		-20~20	
Air filter, Q'ty			Plastic net x 1(washable)	
Remote control			wired:RC-E5 (installed) wireless:RCN-KIT4-E2 (option)	

### NOTES:

The data are measured under the following conditions(ISO-T1).  
 Cooling:Indoor temp. of 27°CDB, 19°CWB, and outdoor temp. of 35°CDB. Heating:Indoor temp. of 20°CDB, and outdoor temp. of 7°CDB, 6°CWB.  
 \*1 : Indicates the value in an anechoic chamber. During operation these values are somewhat higher due to ambient conditions.  
 \*2 : If a cooling operation is conducted when the outdoor air temperature is -5°C or lower, the outdoor unit should be installed at a place where it is not influenced by natural wind. If wind blows, the low pressure will drop and compressor frequency will increase, this will cause the capacity to drop and may cause the unit to break down.  
 \*3 : The values are for one indoor unit operation. (Multi system only)

R410A		Micro Inverter		
Set model name		FDF100VNAVD2	FDF125VNAVD	FDF140VNAVD
Indoor unit		FDF100VD2	FDF125VD	FDF140VD
Outdoor unit		FDC100VNA	FDC125VNA	FDC140VNA
Power source		1 Phase 220-240V, 50Hz / 220V, 60Hz		
Nominal cooling capacity (Min-Max)		10.0 ( 4.0 ~ 11.2 )	12.5 ( 5.0 ~ 13.0 )	13.0 ( 5.0 ~ 13.0 )
Nominal heating capacity (Min-Max)		11.2 ( 4.0 ~ 12.5 )	14.0 ( 4.0 ~ 16.0 )	15.5 ( 4.0 ~ 16.5 )
Power consumption	Cooling/Heating	3.12 / 2.94	4.65 / 4.14	5.02 / 4.98
EER/COP	Cooling/Heating	3.21 / 3.81	2.69 / 3.38	2.59 / 3.11
Inrush current	A	5	5	5
Max. current		24	24	24
Sound power level*1	Indoor	Cooling/Heating	65 / 65	73 / 73
	Outdoor	Cooling/Heating	70 / 70	73 / 73
Sound pressure level*1	Indoor	Cooling (P-Hi/Hi/Me/Lo)	54 / 50 / 48 / 44	54 / 50 / 48 / 44
		Heating (P-Hi/Hi/Me/Lo)	54 / 50 / 48 / 44	54 / 50 / 48 / 44
	Outdoor	Cooling/Heating	54 / 56	55 / 57
		Cooling/Heating	54 / 56	55 / 57
Air flow	Indoor	Cooling (P-Hi/Hi/Me/Lo)	29 / 26 / 23 / 19	29 / 26 / 23 / 19
		Heating (P-Hi/Hi/Me/Lo)	29 / 26 / 23 / 19	29 / 26 / 23 / 19
	Outdoor	Cooling/Heating	75 / 73	75 / 73
Exterior dimensions	Indoor	HeightxWidthxDepth	1,850 x 600 x 320	
	Outdoor	HeightxWidthxDepth	845 x 970 x 370	
Net weight	Indoor	kg	52	
	Outdoor		80	
Ref.piping size	Liquid/Gas	ømm	9.52(3/8") / 15.88(5/8")	
Refrigerant line (one way) length		m	Max.50	
Vertical height differences	Outdoor is higher/lower	m	Max.50 / Max.15	
Outdoor operating temperature range	Cooling	°C	-15~50*2	
	Heating		-20~20	
Air filter, Q'ty		Plastic net x 1 (Washable)		
Remote control		wired:RC-E5 (installed) wireless:RCN-KIT4-E2 (option)		

R410A		Micro Inverter		
Set model name		FDF100VSAVD2	FDF125VSAVD	FDF140VSAVD
Indoor unit		FDF100VD2	FDF125VD	FDF140VD
Outdoor unit		FDC100VSA	FDC125VSA	FDC140VSA
Power source		3 Phase 380-415V, 50Hz / 380V, 60Hz		
Nominal cooling capacity (Min-Max)		10.0 ( 4.0 ~ 11.2 )	12.5 ( 5.0 ~ 14.0 )	13.6 ( 5.0 ~ 14.5 )
Nominal heating capacity (Min-Max)		11.2 ( 4.0 ~ 12.5 )	14.0 ( 4.0 ~ 16.0 )	15.5 ( 4.0 ~ 16.5 )
Power consumption	Cooling/Heating	3.12 / 2.94	4.65 / 4.14	5.42 / 4.98
EER/COP	Cooling/Heating	3.21 / 3.81	2.69 / 3.38	2.51 / 3.11
Inrush current	A	5	5	5
Max. current		15	15	15
Sound power level*1	Indoor	Cooling/Heating	65 / 65	73 / 73
	Outdoor	Cooling/Heating	70 / 70	73 / 73
Sound pressure level*1	Indoor	Cooling (P-Hi/Hi/Me/Lo)	54 / 50 / 48 / 44	54 / 50 / 48 / 44
		Heating (P-Hi/Hi/Me/Lo)	54 / 50 / 48 / 44	54 / 50 / 48 / 44
	Outdoor	Cooling/Heating	54 / 56	55 / 57
		Cooling/Heating	54 / 56	55 / 57
Air flow	Indoor	Cooling (P-Hi/Hi/Me/Lo)	29 / 26 / 23 / 19	29 / 26 / 23 / 19
		Heating (P-Hi/Hi/Me/Lo)	29 / 26 / 23 / 19	29 / 26 / 23 / 19
	Outdoor	Cooling/Heating	75 / 73	75 / 73
Exterior dimensions	Indoor	HeightxWidthxDepth	1,850 x 600 x 320	
	Outdoor	HeightxWidthxDepth	845 x 970 x 370	
Net weight	Indoor	kg	52	
	Outdoor		82	
Ref.piping size	Liquid/Gas	ømm	9.52(3/8") / 15.88(5/8")	
Refrigerant line (one way) length		m	Max.50	
Vertical height differences	Outdoor is higher/lower	m	Max.50 / Max.15	
Outdoor operating temperature range	Cooling	°C	-15~50*2	
	Heating		-20~20	
Air filter, Q'ty		Plastic net x 1 (Washable)		
Remote control		wired:RC-E5 (installed) wireless:RCN-KIT4-E2 (option)		



## SPECIFICATIONS - FDF -

R410A		Micro Inverter			
Set model name		FDF140VNAPVD1	FDF140VSAPVD1	FDF200VSAPVD2	FDF250VSAPVD
Indoor unit		FDF71VD1 x 2	FDF71VD1 x 2	FDF100VD2 x 2	FDF125VD x 2
Outdoor unit		FDC140VNA	FDC140VSA	FDC200VSA	FDC250VSA
Power source		1 Phase 220-240V, 50Hz / 220V, 60Hz		3 Phase 380-415V, 50Hz / 380V, 60Hz	
Nominal cooling capacity (Min~Max)		kW	13.6 ( 5.0 ~ 14.5 )	19.0 ( 5.2 ~ 22.4 )	24.0 ( 6.9 ~ 28.0 )
Nominal heating capacity (Min~Max)		kW	15.5 ( 4.0 ~ 16.5 )	22.4 ( 3.3 ~ 25.0 )	27.0 ( 5.5 ~ 31.5 )
Power consumption		Cooling/Heating kW	5.15 / 4.35	6.74 / 6.42	9.15 / 8.49
EER/COP		Cooling/Heating	2.64 / 3.56	2.82 / 3.49	2.62 / 3.18
Inrush current		A	5	5	5
Max. current			24	15	20
Sound power level*1	Indoor <sup>3</sup>	Cooling/Heating	61 / 61	61 / 61	65 / 65
	Outdoor	Cooling/Heating	73 / 73	73 / 73	72 / 74
Sound pressure level*1	Indoor <sup>3</sup>	Cooling (P-Hi/Hi/Me/Lo)	42 / 39 / 35 / 33	42 / 39 / 35 / 33	54 / 50 / 48 / 44
		Heating (P-Hi/Hi/Me/Lo)	42 / 39 / 35 / 33	42 / 39 / 35 / 33	54 / 50 / 48 / 44
	Outdoor	Cooling/Heating	57 / 59	57 / 59	58 / 59
Air flow	Indoor <sup>3</sup>	Cooling (P-Hi/Hi/Me/Lo)	18 / 16 / 14 / 12	18 / 16 / 14 / 12	29 / 26 / 23 / 19
		Heating (P-Hi/Hi/Me/Lo)	18 / 16 / 14 / 12	18 / 16 / 14 / 12	29 / 26 / 23 / 19
	Outdoor	Cooling/Heating	75 / 73	75 / 73	135 / 135
Exterior dimensions		Indoor	1,850 x 600 x 320		
Outdoor		HeightxWidthxDepth	845 x 970 x 370	1,300 x 970 x 370	1,505 x 970 x 370
Net weight		Indoor	49		
Outdoor			80	82	115
Ref.piping size		Liquid/Gas	9.52(3/8") / 15.88(5/8")		9.52(3/8") / 22.22(7/8")
Refrigerant line (one way) length			Max.50		Max.70
Vertical height differences		Outdoor is higher/lower	Max.50 / Max.15		Max.30 / Max.15
Outdoor operating temperature range		Cooling	-15~50*2		
Heating			-20~20		-15~20
Air filter, Q'ty			Plastic net x 1 (washable)		
Remote control			wired:RC-E5 (installed) wireless:RCN-KIT4-E2 (option)		

R410A		Standard Inverter			
Set model name		FDF71VNPVD1	FDF90VNP1VD2	FDF100VNP1VD2	
Indoor unit		FDF71VD1	FDF100VD2	FDF100VD2	
Outdoor unit		FDC71VNP	FDC90VNP1	FDC100VNP	
Power source		1 Phase 220-240V, 50Hz / 220V, 60Hz			
Nominal cooling capacity (Min~Max)		kW	7.1 ( 1.4 ~ 7.1 )	9.0 ( 1.9 ~ 9.0 )	
Nominal heating capacity (Min~Max)		kW	7.1 ( 1.0 ~ 7.1 )	11.2 ( 2.5 ~ 12.5 )	
Power consumption		Cooling/Heating kW	2.67 / 2.04	2.81 / 2.25	
EER/COP		Cooling/Heating	2.66 / 3.48	3.20 / 4.00	
Inrush current		A	5	5	
Max. current			14.5	18.0	21.0
Sound power level*1	Indoor	Cooling/Heating	61 / 61	65 / 65	
	Outdoor	Cooling/Heating	67 / 67	69 / 69	
Sound pressure level*1	Indoor	Cooling (P-Hi/Hi/Me/Lo)	42 / 39 / 35 / 33	54 / 50 / 48 / 44	
		Heating (P-Hi/Hi/Me/Lo)	42 / 39 / 35 / 33	54 / 50 / 48 / 44	
	Outdoor	Cooling/Heating	54 / 54	57 / 55	
Air flow	Indoor	Cooling (P-Hi/Hi/Me/Lo)	20 / 18 / 16 / 14	29 / 26 / 23 / 19	
		Heating (P-Hi/Hi/Me/Lo)	20 / 18 / 16 / 14	29 / 26 / 23 / 19	
	Outdoor	Cooling/Heating	36 / 36	63 / 49.5	
Exterior dimensions		Indoor	1,850 x 600 x 320		
Outdoor		HeightxWidthxDepth	640 x 800(+71) x 290	750 x 880(+88) x 340	
Net weight		Indoor	49		
Outdoor			45	57	
Ref.piping size		Liquid/Gas	6.35(1/4") / 12.7(1/2")		
Refrigerant line (one way) length			Max.23		
Vertical height differences		Outdoor is higher/lower	Max.20 / Max.20		
Outdoor operating temperature range		Cooling	-15~46*2		
Heating			-15~20		
Air filter, Q'ty			Plastic net x1 (Washable)		
Remote control			wired:RC-E5 (installed) wireless:RCN-KIT4-E2 (option)		

### NOTES:

The data are measured under the following conditions (ISO-T1).  
Cooling: Indoor temp. of 27°CDB, 19°CWB, and outdoor temp. of 35°CDB. Heating: Indoor temp. of 20°CDB, and outdoor temp. of 7°CDB, 6°CWB.  
\*1 : Indicates the value in an anechoic chamber. During operation these values are somewhat higher due to ambient conditions.  
\*2 : If a cooling operation is conducted when the outdoor air temperature is -5°C or lower, the outdoor unit should be installed at a place where it is not influenced by natural wind. If wind blows, the low pressure will drop and compressor frequency will increase, this will cause the capacity to drop and may cause the unit to break down.  
\*3 : The values are for one indoor unit operation. (Multi system only)

# Energy Efficient and Environmentally Conscious

Several radical design changes and engineering developments have brought about a vast improvement in energy efficiency and environmental protection.

## ENERGY LABEL

SEER and SCOP is defined in European regulations listed below.

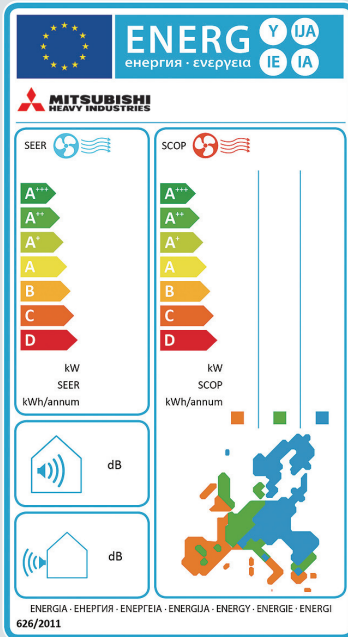

No.626/2011 of 4 May 2011:  
energy labeling of air-conditioners  
(below cooling capacity 12kW).

No.206/2012 of 6 March 2012:  
requirement for air-conditioners and comfort fans.

Seasonal efficiency is the new way of rating the true efficiency of heating and cooling products over an entire year.

Set by the EU's new regulation implementing Eco-Design Directive for Energy Related Product (ErP) which specifies the minimum efficiency of air-conditioners manufacturers must integrate into their products.

The new Seasonal Efficiency rating system that must be used for heating and cooling by all manufacturers are;

**SEER - Seasonal Efficiency Ratio (value in cooling)**  
**SCOP - Seasonal Coefficient of Performance (value in heating)**

The new rating system will indicate the true efficiency of the energy using product at specified condition.

## Employment of lead-free solder

### Adapted to RoHS directive

#### RoHS:Restriction of Hazardous substances

In order to avoid the release of hazardous substances into the environments, all models have utilized lead-free solder application. It has been considered to be difficult to use lead-free solder for practical applications because it requires higher solder temperatures at assembly, which can jeopardize reliability. However our PbF soldering method can produce a higher quality lead-free printed circuit board.

## Employment of R32 R410A

All models use refrigerant R32 or R410A characterized by the ozone depletion coefficient being 0.

## Excellent Energy Saving

High performance and excellent energy savings are achieved at the same time by heat exchanger's increased capacity and employment of high efficiency DC motor.

Indoor unit	FDT40VH	FDT50VH	FDT60VH	FDT40VH	FDT50VH	FDT60VH	FDT71VG	
Outdoor unit	SRC40ZSX-W1	SRC50ZSX-W1	SRC60ZSX-W1	SRC40ZSX-S	SRC50ZSX-S	SRC60ZSX-S	FDC71VNX	
Energy class (cooling/heating)	A+++/A++	A++/A++	A+++/A++	A+++/A+	A++/A++	A++/A++	A+/A+	
SEER	8.63	7.93	8.74	8.51	7.82	8.26	5.72	
SCOP (Average climate)	4.62	4.63	5.00	4.47	4.61	5.00	4.34	
Pdesign (cooling/heating (@-10°C))	kW	4.0/3.9	5.0/4.0	5.6/5.2	4.0/3.8	5.0/4.1	5.6/4.7	7.1/5.8
Annual electricity consumption (cooling/heating)	kWh/a	163/1167	221/1210	225/1455	165/1192	224/1246	238/1316	435/1873
Refrigerant	GWP	R32/675		R410A/1975				
	charge kg/TCO <sub>2</sub> e	1.30/0.878		1.5/3.132			2.95/6.160	
Designated heating season	Average							

Indoor unit	FDT100VG	FDT100VG	FDT40VHx2	FDT50VHx2	FDT50VHx2	FDT100VG	FDT100VG	
Outdoor unit	FDC100VNX	FDC100VSX	FDC71VNX	FDC100VNX	FDC100VSX	FDC100VNA	FDC100VSA	
Energy class (cooling/heating)	A+/A+	A+/A+	A+/A+	A+/A+	A+/A+	A++/A+	A++/A+	
SEER	5.90	5.90	5.77	5.92	5.92	6.78	6.78	
SCOP (Average climate)	4.32	4.32	4.34	4.16	4.16	4.52	4.52	
Pdesign (cooling/heating (@-10°C))	kW	10.0/11.2	10.0/11.2	7.1/5.8	10.0/11.2	10.0/11.2	10.0/8.5	10.0/8.5
Annual electricity consumption (cooling/heating)	kWh/a	594/3628	594/3627	431/1873	592/3772	592/3772	516/2633	516/2633
Refrigerant	GWP	R410A/1975						
	charge kg/TCO <sub>2</sub> e	4.5/9.396		2.95/6.160	4.5/9.396		3.8/7.934	
Designated heating season	Average							

Indoor unit	FDT50VHx2	FDT50VHx2	FDT71VG	FDT100VG	FDT100VG	
Outdoor unit	FDC100VNA	FDC100VSA	FDC71VNP	FDC90VNP1	FDC100VNP	
Energy class (cooling/heating)	A++/A+	A++/A+	A++/A+	A++/A+	A++/A+	
SEER	6.89	6.89	6.14	6.78	6.78	
SCOP (Average climate)	4.47	4.47	4.27	4.12	4.53	
Pdesign (cooling/heating (@-10°C))	kW	10.0/8.5	10.0/8.5	7.1/5.7	9.0/8.1	10.0/8.1
Annual electricity consumption (cooling/heating)	kWh/a	508/2665	508/2665	405/1867	465/2756	517/2506
Refrigerant	GWP	R410A/1975				
	charge kg/TCO <sub>2</sub> e	3.8/7.934		1.6/3.341	2.1/4.385	2.55/5.324
Designated heating season	Average					

- Refrigerant contained in the products is a fluorinated greenhouse gas listed in Regulation (EU) No 517/2014.
- SEER/SCOP are based on EN14825.2016 and Commission regulation(EU) No.2016/2281. Temperature conditions for calculating SCOP are based on "Average climate".
- "tonne(s) of CO<sub>2</sub> equivalent" means a quantity of greenhouse gases- expressed as the product of the weight of the greenhouse gases in metric tonnes and of their global warming potential.

# Energy Efficient and Environmentally Conscious

Indoor unit		FDT40VH	FDT50VH	FDT60VH	FDT40VH	FDT50VH	FDT60VH
Outdoor unit		SRC40ZSX-W1	SRC50ZSX-W1	SRC60ZSX-W1	SRC40ZSX-S	SRC50ZSX-S	SRC60ZSX-S
Energy class (cooling/heating)		A++/A+	A++/A+	A++/A+	A++/A+	A++/A+	A++/A+
SEER		6.94	6.52	6.45	6.93	6.49	6.39
SCOP (Average climate)		4.37	4.30	4.10	4.37	4.30	4.09
Pdesign (cooling/heating (@-10°C))	kW	4.0/4.0	5.0/4.3	5.6/5.1	4.0/4.0	5.0/4.3	5.6/5.4
Annual electricity consumption (cooling/heating)	kWh/a	202/1283	269/1401	304/1744	202/1281	270/1402	307/1848
Refrigerant	GWP	R32/675			R410A/1975		
	charge kg/TCO <sub>2</sub> e	1.30/0.878			1.5/3.132		
Designated heating season		Average					

Indoor unit		FDT40VHx2	FDT50VHx2	FDT50VHx2	FDT50VHx2	FDT50VHx2
Outdoor unit		FDC71VNX	FDC100VNX	FDC100VSX	FDC100VNA	FDC100VSA
Energy class (cooling/heating)		A/A+	A/A	A/A	A+/A+	A+/A+
SEER		5.50	5.56	5.56	6.00	6.00
SCOP (Average climate)		4.05	3.87	3.87	4.38	4.38
Pdesign (cooling/heating (@-10°C))	kW	7.1/6.0	10.0/10.8	10.0/10.8	10.0/8.4	10.0/8.4
Annual electricity consumption (cooling/heating)	kWh/a	453/2077	630/3910	630/3910	584/2682	584/2682
Refrigerant	GWP	R410A/1975				
	charge kg/TCO <sub>2</sub> e	2.95/6.160	4.5/9.396		3.8/7.934	
Designated heating season		Average				

Indoor unit		FDU17VF1	FDU100VF2	FDU100VF2	FDU100VF2	FDU100VF2	FDU17VF1	FDU100VF2	FDU100VF2
Outdoor unit		FDC71VNX	FDC100VNX	FDC100VSX	FDC100VNA	FDC100VSA	FDC71VNP	FDC90VNP1	FDC100VNP
Energy class (cooling/heating)		A/A	A/A+	A/A+	A++/A+	A++/A+	A+/A+	A++/A	A++/A+
SEER		5.24	5.22	5.19	6.11	6.11	5.73	6.56	6.36
SCOP (Average climate)		3.90	4.10	4.10	4.19	4.19	4.00	3.98	4.13
Pdesign (cooling/heating (@-10°C))	kW	7.1/7.0	10.0/13.0	10.0/13.0	10.0/8.5	10.0/8.5	7.1/5.7	9.0/8.1	10.0/8.1
Annual electricity consumption (cooling/heating)	kWh/a	475/2513	670/4437	675/4441	573/2843	573/2843	434/1995	480/2848	551/2746
Refrigerant	GWP	R410A/1975							
	charge kg/TCO <sub>2</sub> e	2.95/6.160	4.5/9.396		3.8/7.934		1.6/3.341	2.1/4.385	2.55/5.324
Designated heating season		Average							

Indoor unit		FDUM40VH	FDUM50VH	FDUM60VH	FDUM40VH	FDUM50VH	FDUM60VH	FDUM71VF1	
Outdoor unit		SRC50ZSX-W1	SRC50ZSX-W1	SRC60ZSX-W1	SRC40ZSX-S	SRC50ZSX-S	SRC60ZSX-S	FDC71VNX	
Energy class (cooling/heating)		A+/A	A+/A	A++/A+	A+/A+	A+/A+	A++/A+	A/A	
SEER		6.11	5.82	6.43	6.01	5.68	6.42	5.24	
SCOP (Average climate)		3.81	3.89	4.37	4.15	4.36	4.37	3.90	
Pdesign (cooling/heating (@-10°C))	kW	4.0/3.0	5.0/3.7	5.6/4.7	4.0/3.5	5.0/4.3	5.6/5.4	7.1/7.0	
Annual electricity consumption (cooling/heating)	kWh/a	230/1102	301/1332	305/1508	233/1182	309/1380	306/1731	475/2513	
Refrigerant	GWP	R32/675						R410A/1975	
	charge kg/TCO <sub>2</sub> e	1.30/0.878				1.5/3.132		2.95/6.160	
Designated heating season		Average							

Indoor unit		FDUM100VF2	FDUM100VF2	FDUM40VHx2	FDUM50VHx2	FDUM50VHx2	FDUM100VF2	FDUM100VF2
Outdoor unit		FDC100VNX	FDC100VSX	FDC71VNX	FDC100VNX	FDC100VSX	FDC100VNA	FDC100VSA
Energy class (cooling/heating)		A/A+	A/A+	A+/A+	A/A	A/A	A++/A+	A++/A+
SEER		5.22	5.19	5.61	5.14	5.11	6.11	6.11
SCOP (Average climate)		4.10	4.10	4.05	3.88	3.87	4.19	4.19
Pdesign (cooling/heating (@-10°C))	kW	10.0/13.0	10.0/13.0	7.1/7.0	10.0/10.0	10.0/10.0	10.0/8.5	10.0/8.5
Annual electricity consumption (cooling/heating)	kWh/a	670/4437	675/4441	444/2419	681/3606	685/3618	573/2843	573/2843
Refrigerant	GWP	R410A/1975						
	charge kg/TCO <sub>2</sub> e	4.5/9.396		2.95/6.160	4.5/9.396		3.8/7.934	
Designated heating season		Average						

Indoor unit		FDUM50VHx2	FDUM50VHx2	FDUM71VF1	FDUM100VF2	FDUM100VF2
Outdoor unit		FDC100VNA	FDC100VSA	FDC71VNP	FDC90VNP1	FDC100VNP
Energy class (cooling/heating)		A/A	A/A	A+/A+	A++/A	A++/A+
SEER		5.50	5.50	5.73	6.56	6.36
SCOP (Average climate)		3.94	3.94	4.00	3.98	4.13
Pdesign (cooling/heating (@-10°C))	kW	10.0/8.5	10.0/8.5	7.1/5.7	9.0/8.1	10.0/8.1
Annual electricity consumption (cooling/heating)	kWh/a	637/3024	637/3024	434/1995	480/2848	551/2746
Refrigerant	GWP	R410A/1975				
	charge kg/TCO <sub>2</sub> e	3.8/7.934		1.6/3.341	2.1/4.385	2.55/5.324
Designated heating season		Average				

Indoor unit		SRK50ZSX-Wx2	SRK50ZSX-Wx2	SRK100ZR-S	SRK100ZR-S	SRK100ZR-S
Outdoor unit		FDC100VNX	FDC100VSX	FDC100VNA	FDC100VSA	FDC100VNP
Energy class (cooling/heating)		A++/A+	A++/A+	A++/A+	A++/A+	A++/A+
SEER		6.11	6.11	6.26	6.26	6.60
SCOP (Average climate)		4.16	4.16	4.33	4.33	4.40
Pdesign (cooling/heating (@-10°C))	kW	10.0/10.4	10.0/10.4	10.0/8.5	10.0/8.5	10.0/7.2
Annual electricity consumption (cooling/heating)	kWh/a	574/3504	574/3504	560/2750	560/2750	531/2289
Refrigerant	GWP	R410A/1975				
	charge kg/TCO <sub>2</sub> e	4.5/9.396		3.8/7.934		2.55/5.324
Designated heating season		Average				

Indoor unit	FDE40VH	FDE50VH	FDE60VH	FDE40VH	FDE50VH	FDE60VH	FDE71VH
Outdoor unit	SRC40ZSX-W1	SRC50ZSX-W1	SRC60ZSX-W1	SRC40ZSX-S	SRC50ZSX-S	SRC60ZSX-S	FDC71VNX
Energy class (cooling/heating)	A++/A+	A++/A+	A++/A+	A++/A	A++/A	A++/A+	B/A+
SEER	6.46	6.15	6.72	6.46	6.10	6.72	4.87
SCOP (Average climate)	4.02	4.07	4.41	3.93	3.92	4.08	4.00
Pdesign (cooling/heating (@-10°C))	kW	4.0/3.0	5.0/3.8	5.6/4.5	4.0/3.0	5.0/3.8	5.6/4.3
Annual electricity consumption (cooling/heating)	kWh/a	217/1045	285/1307	292/1430	217/1070	288/1359	292/1476
Refrigerant	GWP	R32/675			R410A/1975		
	charge kg/TCO <sub>2</sub> e	1.30/0.878			1.5/3.132		
Designated heating season		Average					

Indoor unit	FDE100VG	FDE100VG	FDE40VHx2	FDE50VHx2	FDE50VHx2	FDE100VG	FDE100VG
Outdoor unit	FDC100VNX	FDC100VNX	FDC71VNX	FDC100VNX	FDC100VNX	FDC100VNA	FDC100VSA
Energy class (cooling/heating)	A+/A+	A+/A+	A/A+	A/A	A/A	A++/A+	A++/A+
SEER	5.89	5.84	5.26	5.53	5.49	6.35	6.35
SCOP (Average climate)	4.18	4.17	4.09	3.94	3.94	4.31	4.31
Pdesign (cooling/heating (@-10°C))	kW	10.0/11.2	10.0/11.2	7.1/6.0	10.0/10.8	10.0/10.8	10.0/8.5
Annual electricity consumption (cooling/heating)	kWh/a	595/3754	599/3758	473/2056	634/3840	638/3841	552/2762
Refrigerant	GWP	R410A/1975					
	charge kg/TCO <sub>2</sub> e	4.5/9.396		2.95/6.160	4.5/9.396		3.8/7.934
Designated heating season		Average					

Indoor unit	FDE50VHx2	FDE50VHx2	FDE71VG	FDE100VG	FDE100VG
Outdoor unit	FDC100VNA	FDC100VSA	FDC71VNP	FDC90VNP1	FDC100VNP
Energy class (cooling/heating)	A+/A+	A+/A+	A++/A+	A++/A+	A++/A+
SEER	5.71	5.71	6.35	6.63	6.73
SCOP (Average climate)	4.10	4.10	4.22	4.25	4.44
Pdesign (cooling/heating (@-10°C))	kW	10.0/8.5	10.0/8.5	7.1/5.8	9.0/8.2
Annual electricity consumption (cooling/heating)	kWh/a	613/2905	613/2905	392/1925	475/2704
Refrigerant	GWP	R410A/1975			
	charge kg/TCO <sub>2</sub> e	3.8/7.934		1.6/3.341	2.1/4.385
Designated heating season		Average			

Indoor unit	FDV71VD1	FDV100VD2	FDV100VD2	FDV100VD2	FDV100VD2	FDV71VD1	FDV100VD2	FDV100VD2
Outdoor unit	FDC71VNX	FDC100VNX	FDC100VNX	FDC100VNA	FDC100VSA	FDC71VNP	FDC90VNP1	FDC100VNP
Energy class (cooling/heating)	B/A	A/A	A/A	A+/A+	A+/A+	A/A	A+/A+	A/A
SEER	4.80	5.20	5.17	5.70	5.70	5.25	5.69	5.41
SCOP (Average climate)	3.81	3.80	3.80	4.00	4.00	3.91	4.01	3.94
Pdesign (cooling/heating (@-10°C))	kW	7.1/6.7	10.0/13.0	10.0/13.0	10.0/8.5	10.0/8.5	7.1/5.5	9.0/8.1
Annual electricity consumption (cooling/heating)	kWh/a	518/2464	673/4792	678/4795	614/2978	614/2978	474/1972	554/2825
Refrigerant	GWP	R410A/1975						
	charge kg/TCO <sub>2</sub> e	2.95/6.160	4.5/9.396		3.8/7.934		1.6/3.341	2.1/4.385
Designated heating season		Average						

- Refrigerant contained in the products is a fluorinated greenhouse gas listed in Regulation (EU) No 517/2014.
- SEER/SCOP are based on EN14825.2016 and Commission regulation(EU) No.2016/2281. Temperature conditions for calculating SCOP are based on 'Average climate'.
- 'tonne(s) of CO<sub>2</sub> equivalent' means a quantity of greenhouse gases- expressed as the product of the weight of the greenhouse gases in metric tonnes and of their global warming potential.

### SEER and SCOP is defined in European regulations listed below.

No.2016/2281: requirement for air-heating products, cooling products, high temperature process chillers and fan coil units. Seasonal efficiency is the new way of rating the true efficiency of heating and cooling products over an entire year.

Set by the EU's new regulation implementing Eco-Design Directive for Energy Related Product (ErP) which specifies the minimum efficiency of air-conditioners manufacturers must integrate into their products.

The new Seasonal Efficiency rating system that must be used for heating and cooling by all manufacturers are;

Indoor unit	FDT125VG	FDT140VG	FDT125VG	FDT140VG	FDT125VG	FDT140VG	FDT125VG	FDT140VG
Outdoor unit	FDC125VNX	FDC140VNX	FDC125VNX	FDC140VNX	FDC125VNA	FDC140VNA	FDC125VSA	FDC140VSA
SEER	5.77	5.66	5.94	5.82	6.52	6.16	6.52	6.16
SCOP (Average climate)	4.08	4.04	4.03	3.99	4.38	4.28	4.38	4.28

Indoor unit	FDU125VF	FDU140VF	FDU125VF	FDU140VF	FDU125VF	FDU140VF	FDU125VF	FDU140VF	FDU200VG	FDU250VG
Outdoor unit	FDC125VNX	FDC140VNX	FDC125VNX	FDC140VNX	FDC125VNA	FDC140VNA	FDC125VSA	FDC140VSA	FDC200VSA	FDC250VSA
SEER	5.34	5.22	5.49	5.36	5.26	5.08	5.26	5.08	5.06	4.82
SCOP (Average climate)	3.87	3.85	3.91	3.88	4.13	4.01	4.13	4.01	3.52	3.51

Indoor unit	FDUM125VF	FDUM140VF	FDUM125VF	FDUM140VF	FDUM125VF	FDUM140VF	FDUM125VF	FDUM140VF
Outdoor unit	FDC125VNX	FDC140VNX	FDC125VNX	FDC140VNX	FDC125VNA	FDC140VNA	FDC125VSA	FDC140VSA
SEER	5.34	5.22	5.49	5.36	5.26	5.08	5.26	5.08
SCOP (Average climate)	3.87	3.85	3.91	3.88	4.13	4.01	4.13	4.01

Indoor unit	FDE125VG	FDE140VG	FDE125VG	FDE140VG	FDE125VG	FDE140VG	FDE125VG	FDE140VG
Outdoor unit	FDC125VNX	FDC140VNX	FDC125VNX	FDC140VNX	FDC125VNA	FDC140VNA	FDC125VSA	FDC140VSA
SEER	5.56	5.41	5.74	5.56	6.03	5.76	6.03	5.76
SCOP (Average climate)	3.71	3.66	3.66	3.62	4.30	4.15	4.30	4.15

Indoor unit	FDV125VD	FDV140VD	FDV125VD	FDV140VD	FDV125VD	FDV140VD	FDV125VD	FDV140VD
Outdoor unit	FDC125VNX	FDC140VNX	FDC125VNX	FDC140VNX	FDC125VNA	FDC140VNA	FDC125VSA	FDC140VSA
SEER	4.97	4.80	5.11	4.94	5.36	5.09	5.36	5.03
SCOP (Average climate)	3.60	3.56	3.60	3.60	3.96	4.16	3.96	4.16

# Control Systems

## Remote Control line up

wired	indoor unit	remote control	wireless	indoor unit	remote control	indoor unit	remote control
	all models	RC-EX3A RC-E5 RCH-E3		FDT FDTC	RCN-T-5AW-E2 RCN-TC-5AW-E2	FDE FDU,FDUM,PDF	RCN-E-E3 RCN-KIT4-E2

### Wired remote control

option

## RC-EX3A

Easy touch and Easy view with full dot Liquid Crystal display

### User friendly

- LCD panel with light tap operation introduced as the industry's first
- Simple interface with only three buttons

### Easy view

- Big LCD with 3.8 inch full dot display
- Back light function
- Multi language display (12 languages)

**Operation mode setting screen**

The desired operation mode can be selected by simply tapping this button.

**Setting temperature screen**

You can select the temperature as desired by tapping ▲ ▼ button.

**High power operation**

The highest capacity operation (Max 15 minutes)

- Increasing compressor speed
- Increasing air flow volume

**Energy-saving operation**

- Changes set temperature. At 28°C in cooling mode and 22°C in heating mode, 25°C in auto mode.
- Operation correction by outdoor temperature

**Run / Stop**

## Main functions

	Function name	Description
Economy & Timer	<b>Energy-saving operation</b>	Since the capacity is controlled automatically based on the outdoor temperature, energy can be saved without losing comfort.
	<b>Sleep timer</b>	Set the time period from start to stop of operation. The selectable range of setting time is from 30 to 240 minutes (at 10-minute intervals).
	<b>Set temperature auto return</b>	The temperature automatically returns to the previously set temperature.
	<b>Set ON timer by hour</b>	When the set time elapses, the air conditioner starts.
	<b>Set OFF timer by hour</b>	When the set time elapses, the air conditioner stops.
	<b>Set ON timer by clock</b>	The air conditioner starts at the set time.
	<b>Set OFF timer by clock</b>	The air conditioner stops at the set time.
	<b>Weekly timer</b>	On or Off timer can be set on a weekly basis.
	<b>Peak-cut timer</b>	Capacity control can be set by using peak cut function on RC-EX3A for better energy saving. Five-step capacity control is available.
	<b>Home leave operation</b>	When the unit is not used for a long period of time, the room temperature is maintained at a moderate level, avoiding extremely hot or cool temperatures.
Comfort	<b>Big LCD &amp; Touch screen panel</b>	Large 3.8 inch screen has resulted in improved visibility and operability.
	<b>Easy modification of individual flap control</b>	User can visually confirm and set the direction of louvers using the visual display on the remote control.
	<b>Automatic fan speed *1</b>	The micro-computer automatically adjusts the airflow effectively to follow the changes of return air temperature.
	<b>Temp increment setting</b>	Temperature increment for the change of the set temp can be changed.
	<b>Silent mode</b>	Set the period of time to operate the Outdoor unit with prioritizing the quietness.

	Function name	Description
Convenience	<b>Function switch *1</b>	The function switch allows user to select and set two functions among available functions .
	<b>Favourite setting *1</b>	Operation mode, set temperature, fan speed and air flow direction automatically adjust to the programmed favourite setting.
	<b>Adjusting Brightness of the operation lamp</b>	The brightness of the background light can be adjusted by 10 stages.
	<b>LCD contrast setting</b>	This function allows user to adjust LCD display contrast.
	<b>High power operation</b>	High Power Mode increases the unit operating ability for 15 minutes to quickly adjust the room temperature to a comfortable level.
	<b>Back light setting</b>	This convenient function allows user to see controls under low light conditions.
	<b>Administrator settings</b>	This function only allows specific individuals to operate the unit.
	<b>Setting temp range</b>	Limited range of setting temperature in the heating or the cooling operation can be selected.
	<b>External Input / Output Function</b>	The external input/output of indoor unit by remote controller can set input/output based on user needs.
	<b>Select the language</b>	Set the language to be displayed on the remote control.
Service	<b>USB connection (mini-B)</b>	This function allows batch input of schedule timer settings and other settings involving a large amount of data.
	<b>Error code display</b>	This function allows user to check information displayed when abnormal function of the unit occurs.
	<b>Operation data display</b>	Displays various types of air conditioner operation data in real time.
	<b>Contact company display</b>	Address of the service contact is displayed.
	<b>Filter sign</b>	Announces the due time for cleaning of the air filter.
	<b>Static pressure adjustment</b>	Allows user to adjust duct static pressure using the remote control.
	<b>Backup Control</b>	Allows for rotation control, fault backup control, and capacity backup control.

\*1 Cannot be used when a centralized control remote is connected.



# Remote Control line up Wired / Wireless

## Wired remote control

option

# RC-E5



The RC-E5 control enables extensive access to service and maintenance technical data combined with easy to use functions and a clear LCD display.

### Weekly timer function as standard

RC-E5 provides (as a standard feature) a weekly timer, which allows one-week operation schedules to be registered. A user can specify up to four times a day to start/stop the air conditioner. (Temperature setting is also possible with the timer).

### Timer operation

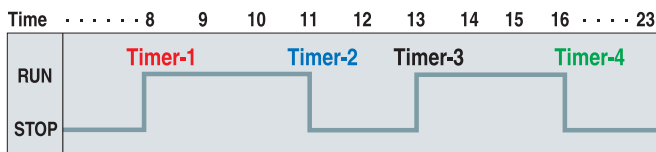

### Run hour meters to facilitate maintenance checking

RC-E5 stores operation data when an anomaly occurs and indicates the error on the LCD. It also displays cumulative operation hours of the air conditioner and compressor since commissioning.

### Room temperature controlled by the remote control sensor

The temperature sensor is housed in the top section of the remote control unit. This arrangement has improved the sensitivity of the remote control unit's sensor, which permits more finely controlled air conditioning.

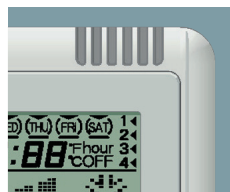

### Adjustable set temperature ranges

RC-E5 allows the upper and lower limits of a set temperature range to be specified separately. By adjusting a set temperature range, you can ensure energy saving air conditioning by avoiding excessive cooling or heating.

Changeable range	
Upper limit	20~30°C (effective for heating operation)
Lower limit	18~26°C (effective for non-heating operation)

## Simple remote control

option

# RCH-E3 (wired)



Considering specialized usage in hotel rooms, control buttons are limited only to minimum required functions such as ON/OFF, mode, temperature setting and fan speed. It is really simple and easy to use.

※ RCH-E3 is not applicable to the Individual flap control system. When RCH-E3 is used, the fan has 3 speed settings (Hi-Me-Lo) only.

### Up to 16 units

It can control up to 16 units individually, with pressing the AIR CON No. button.

### AUTO restart

This function allows starting the air conditioner automatically when power supply is restored after power failure or by turning on the power switch.

## Wireless remote control

option

# RCN-T-5AW-E2

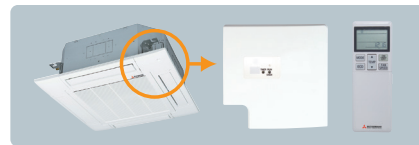

For wireless control simply insert the infrared receiver kit on a corner of the panel.

※ Wireless remote control is not applicable to the Individual flap control system.

# RCN-TC-5AW-E2



# RCN-KIT4-E2



# RCN-E-E3



## Thermistor

option

# SC-THB-E3

In case sensor in the indoor units or the remote control sensor can not sense the room temperature correctly, or individual remote control in each room is not required but only sensor is required (as when center control system is in place), install SC-THB-E3 at proper place in the rooms.



# SUPERLINK II

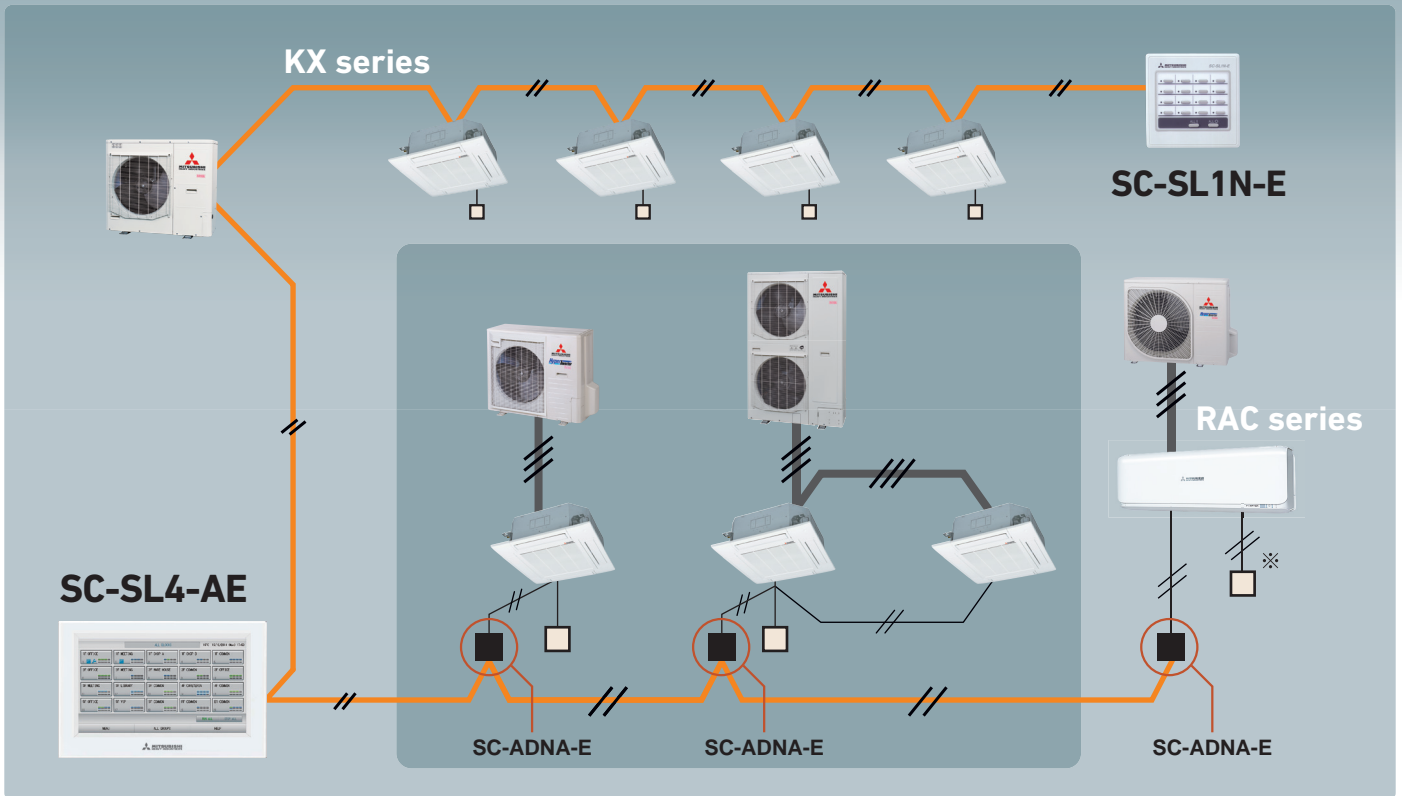

※ SC-BIKN2-E is necessary to connect to wired remote controller.

## Central Control



### SC-SL1N-E

Start/stop control of up to 16 indoor units is possible either individually or collectively. With simple operations, you can effect centralized control.

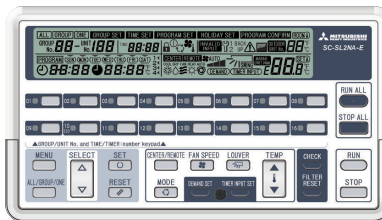

### SC-SL2NA-E

Centralized control of up to 64 indoor units. Including weekly timer function as standard.

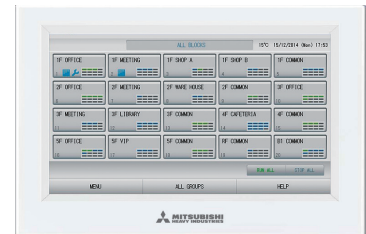

### SC-SL4-AE/BE

Easy operation realized with a large color LCD and touch panel. Up to 128 indoor units can be controlled, when SUPERLINK-II systems are connected.

## Building Management Systems

Production by order



Users can manage up to 1024 units by connecting the four devices !!

### SC-WBGW256\*

Web gateway  
BACnet gateway

SC-WBGW256, up to 256 cells (some cells can have two or more indoor units and total number of indoor units can be up to 256 units) are controlled from the Internet Explorer and centrally from Building Management Systems.

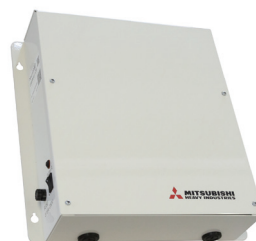

### SC-LGWNB\*

LonWorks gateway

Up to 96 indoor units can be integrated to a central control point via the building management system network.

\* Additional engineering service is required. Please consult your dealer when using these system.

# SUPERLINK E BOARD (SC-ADNA-E)

This board is used when conducting control of the single package (wired remote control unit) 1-type series using a network option (SC-SL1N-E, SC-SL2NA-E, etc).

- (1) Functions**
- (a) Transmits the settings from the network option to the indoor units.
  - (b) Returns the priority indoor unit data in response to a data request from the network option.
  - (c) Inspects the error status of connected indoor units and transmits the inspection codes to the network option.
  - (d) A maximum of 16 units can be controlled (if in the same operation mode).

## (2) Wiring connection diagram

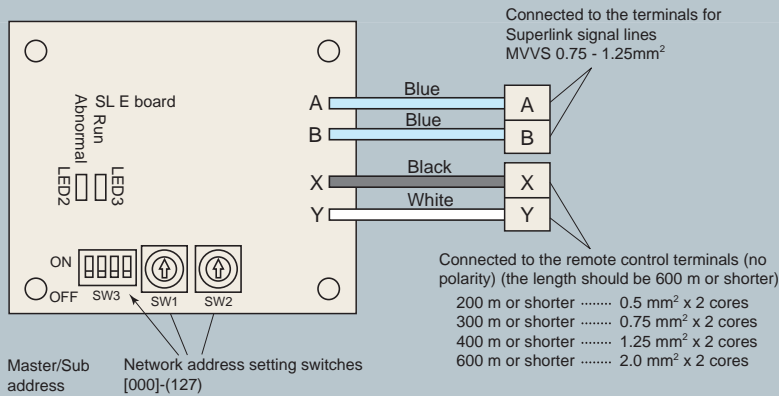

## (3) Metal box dimension (unit:mm)

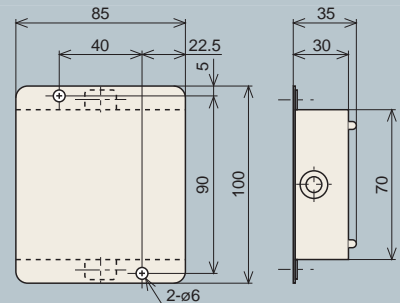

### Basic Connections

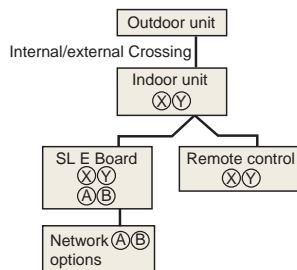

### Plural Controls by Multiple Remote Controls. Mixture of Multiple Units

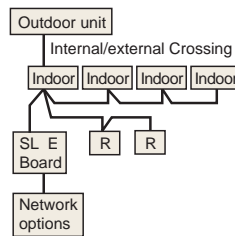

- Transmit the information of plural "Master" units to the network.
- Transmit the abnormalities of the "Slave" units to the network.
- ▶ Setting the plural "Master/Slave" units with the dip SW of the printed circuit board.
- ▶ Setting the "Master/Slave" remote controls with the dip SW of the remote control board.

### Plural Controls by Multiple Remote Controls. Mixture of Multiple Units

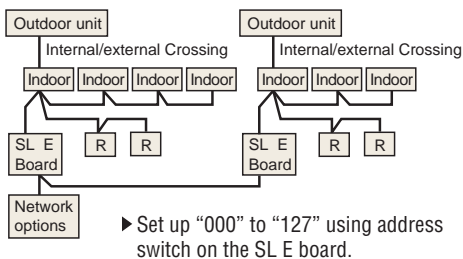

### Without Remote Control

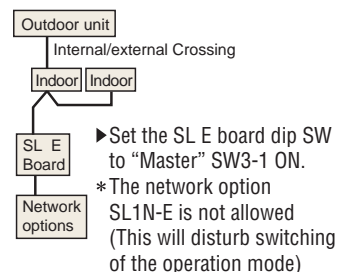

### Wireless Kit

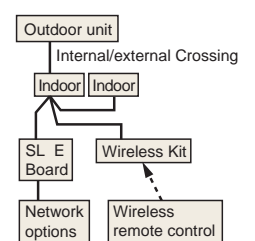

## External switch connection CNT, CNTA

All indoor units are equipped with an additional connection point CnT to connect indoor units to an external ON/OFF switch; e.g. time clock, fire alarm, etc.

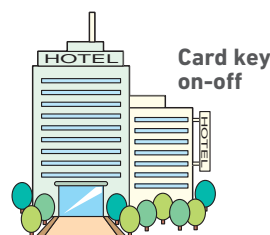

# Outdoor Unit Dimensions (Unit:mm)

SRC40ZSX-W1, 50ZSX-W1, 60ZSX-W1 SRC40ZSX-S, 50ZSX-S, 60ZSX-S

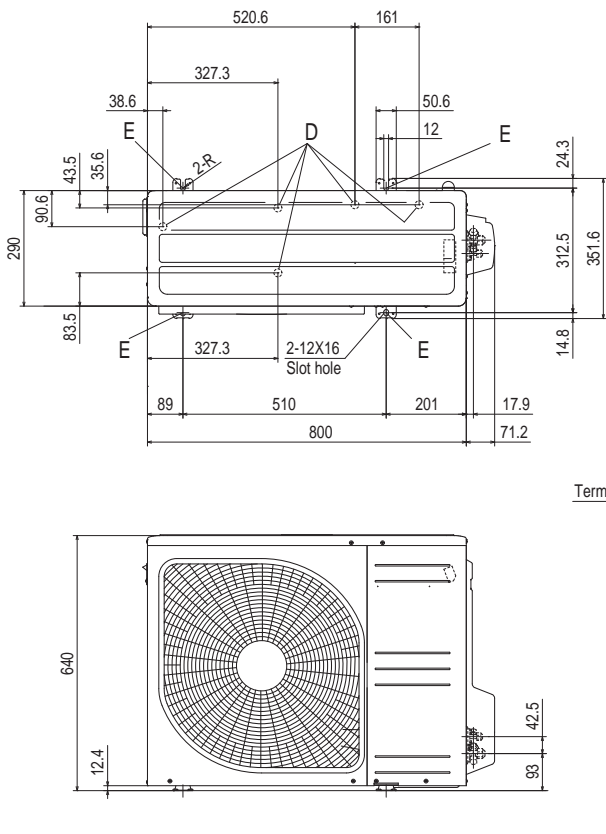

Symbol	Content	
A	Service valve connection (Gas side)	φ12.7(1/2")(Flare)
B	Service valve connection (Liquid side)	φ6.35(1/4")(Flare)
C	Pipe/cable draw-out hole	
D	Drain discharge hole	φ20x5 places
E	Anchor bolt hole	M10-12x4 places

### Notes

- (1) The unit must not be surrounded by walls on the four sides.
- (2) The unit must be fixed with anchor bolts. An anchor bolt must not protrude more than 15mm.
- (3) If the unit is installed in the location where there is a possibility of strong winds, place the unit such that the direction of air from the outlet gets perpendicular to the wind direction.
- (4) Leave 200mm or more space above the unit.
- (5) The wall height on the outlet side should be 1200mm or less.
- (6) The model name label is attached on the front side of the unit.

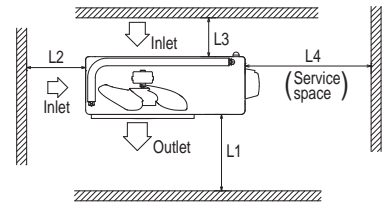

Minimum installation space

Size	Examples installation			
	I	II	III	IV
L1	Open	280	280	180
L2	100	75	Open	Open
L3	100	80	80	80
L4	250	Open	250	Open

## FDC71VNX

Symbol	Content	
A	Service valve connection (gas side)	φ15.88 (5/8") (Flare)
B	Service valve connection (liquid side)	φ9.52 (3/8") (Flare)
C	Pipe/cable draw-out hole	
D	Drain discharge hole	φ20 x 3places
E	Anchor bolt hole	M10 x 4places

### Notes

- (1) It must not be surrounded by walls on the four sides.
- (2) The unit must be fixed with anchor bolts. An anchor bolt must not protrude more than 15mm.
- (3) Where the unit is subject to strong winds, lay it in such a direction that the blower outlet faces perpendicularly to the dominant wind direction.
- (4) Leave 1m or more space above the unit.
- (5) A wall in front of the blower outlet must not exceed the units height.
- (6) The model name label is attached on the lower right corner of the front panel.

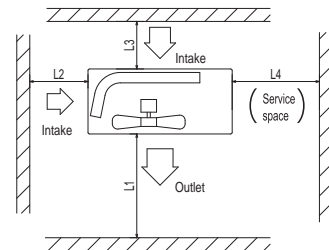
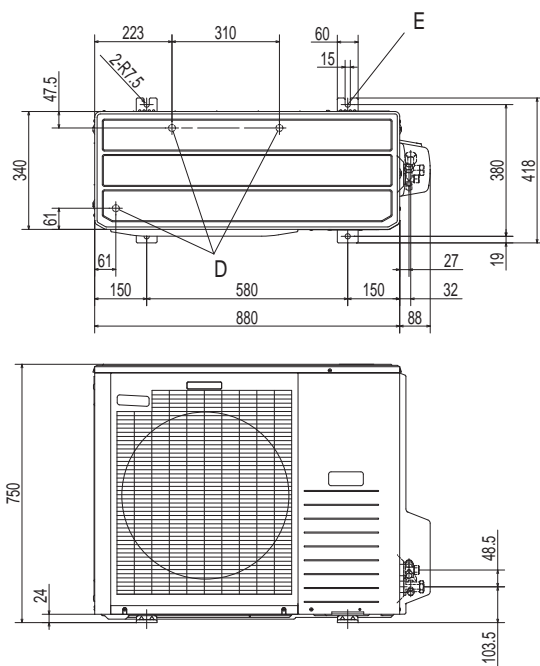

Minimum installation space

Dimensions	Examples of installation		
	I	II	III
L1	Open	Open	500
L2	300	250	Open
L3	100	150	100
L4	250	250	250

# Outdoor Unit Dimensions (Unit:mm)

FDC100VNX, 100VSX, 125VNX, 125VSX,  
140VNX, 140VSX

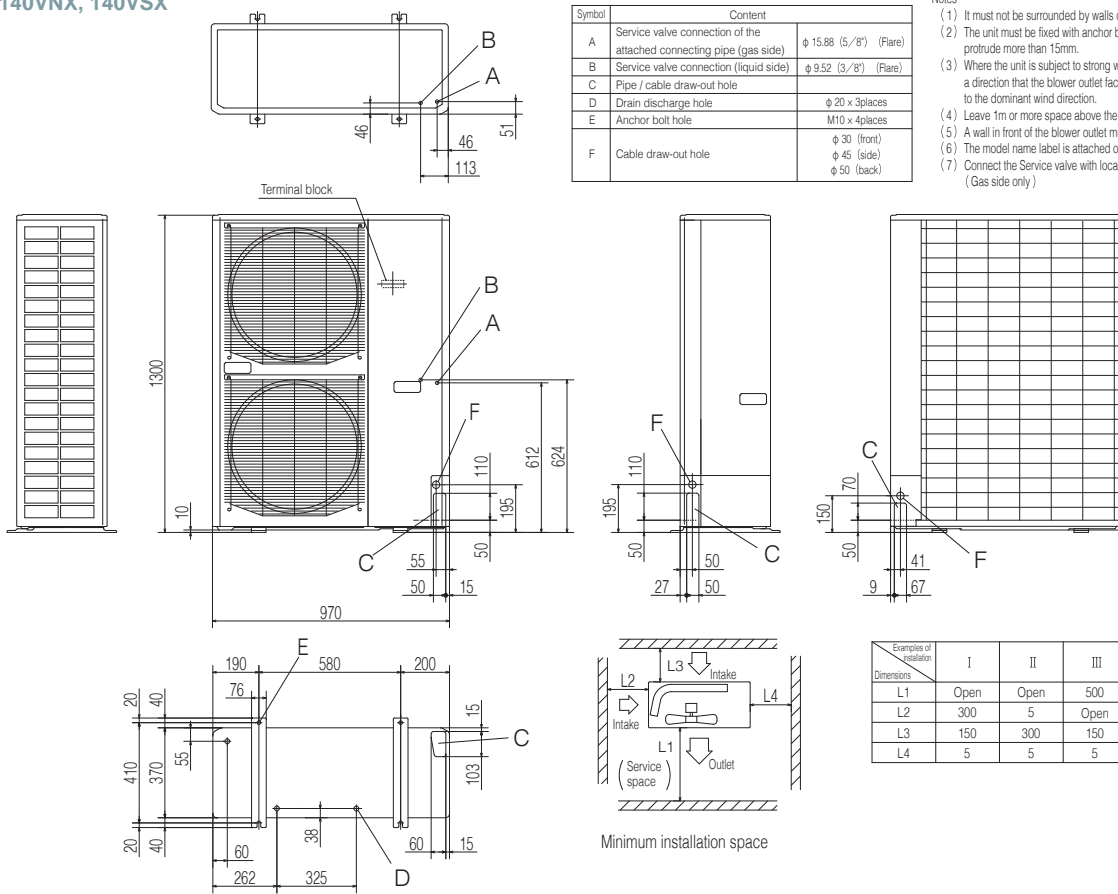

- Notes
- (1) It must not be surrounded by walls on the four sides.
  - (2) The unit must be fixed with anchor bolts. An anchor bolt must not protrude more than 15mm.
  - (3) Where the unit is subject to strong winds, lay it in such a direction that the blower outlet faces perpendicularly to the dominant wind direction.
  - (4) Leave 1m or more space above the unit.
  - (5) A wall in front of the blower outlet must not exceed the units height.
  - (6) The model name label is attached on the lower right corner of the front panel.
  - (7) Connect the Service valve with local pipe by using the pipe of the attachment. (Gas side only)

FDC100VNA, 125VNA, 140VNA  
100VSA, 125VSA, 140VSA

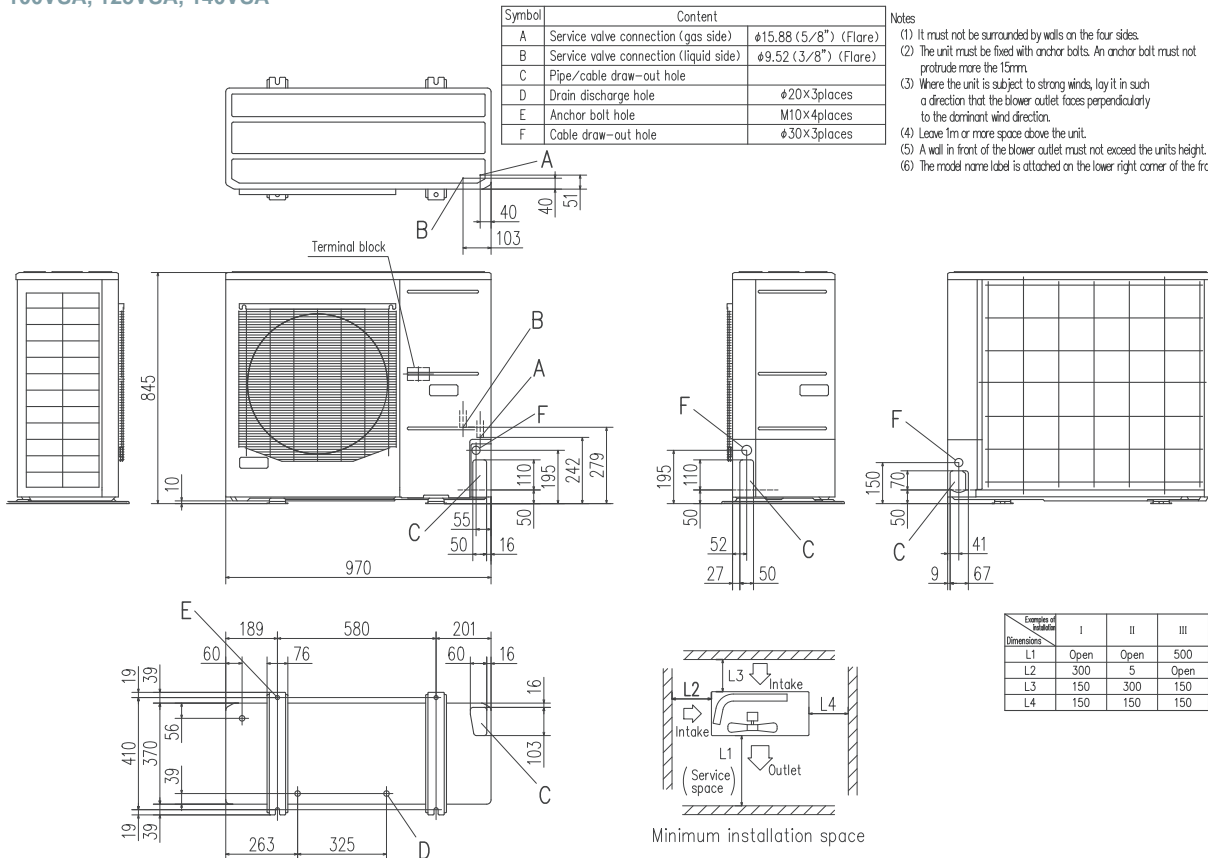

- Notes
- (1) It must not be surrounded by walls on the four sides.
  - (2) The unit must be fixed with anchor bolts. An anchor bolt must not protrude more than 15mm.
  - (3) Where the unit is subject to strong winds, lay it in such a direction that the blower outlet faces perpendicularly to the dominant wind direction.
  - (4) Leave 1m or more space above the unit.
  - (5) A wall in front of the blower outlet must not exceed the units height.
  - (6) The model name label is attached on the lower right corner of the front panel.



# Outdoor Unit Dimensions (Unit:mm)

## FDC200VSA

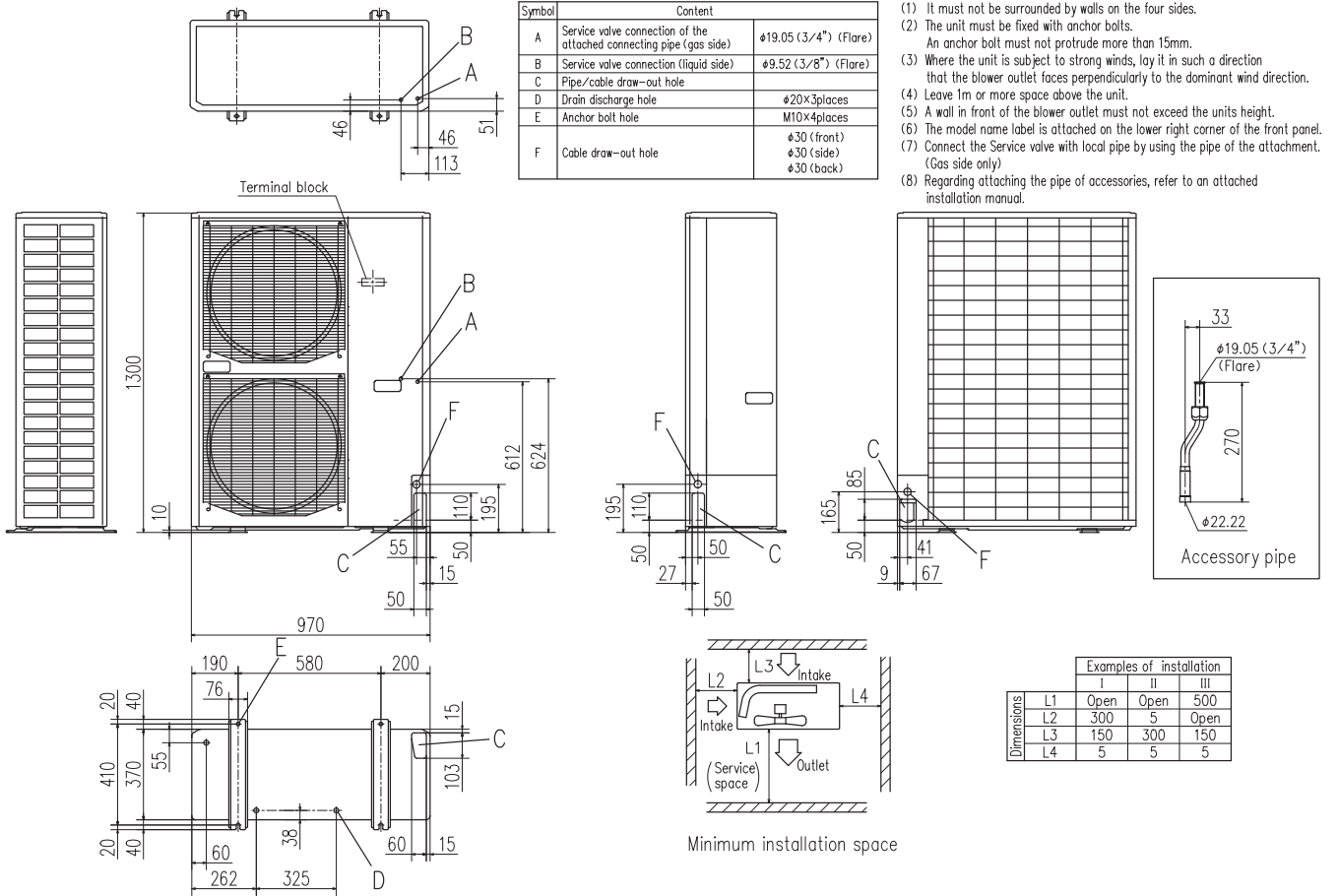

## FDC250VSA

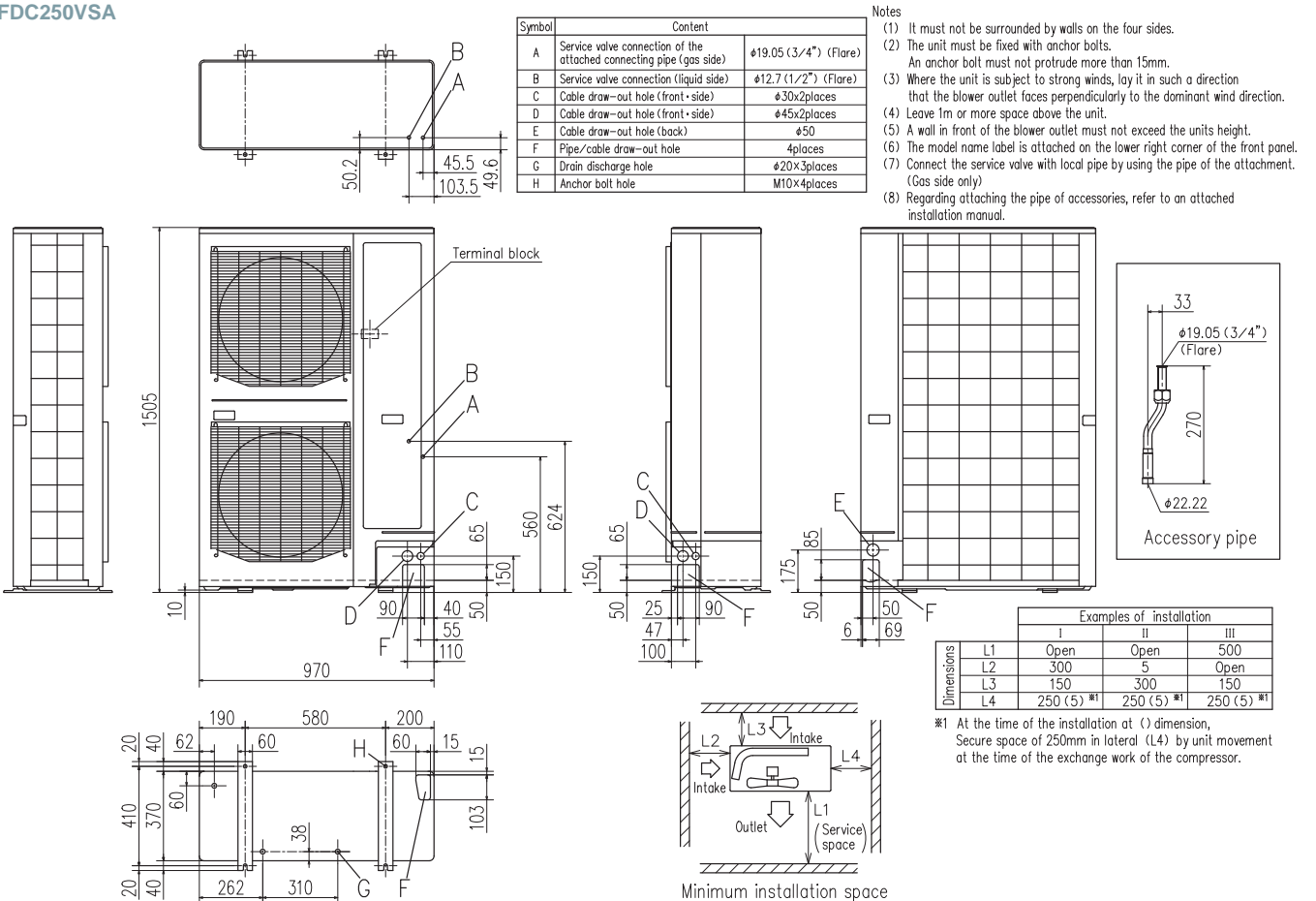

# Outdoor Unit Dimensions (Unit:mm)

## FDC71VNP

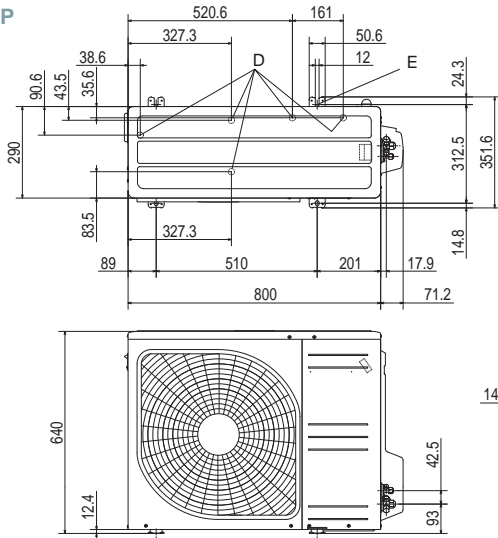

Symbol	Content
A	Service valve connection (gas side) $\phi 12.7(1/2)$ ( Flare)
B	Service valve connection (liquid side) $\phi 6.35(1/4)$ ( Flare)
C	Pipe/cable draw-out hole
D	Drain discharge hole $\phi 20 \times 5$ places
E	Anchor bolt hole M10x 4 places

### Notes

- (1) It must not be surrounded by walls on the four sides.
- (2) The unit must be fixed with anchor bolts. An anchor bolt must not protrude more than 15mm.
- (3) Where the unit is subject to strong winds, lay it in such a direction that the blower outlet faces perpendicularly to the dominant wind direction.
- (4) Leave 1m or more space above the unit.
- (5) A wall in front of the blower outlet must not exceed the units height.
- (6) The model name label is attached on the lower right corner of the front panel.

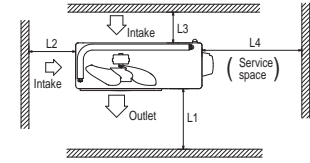

Minimum installation space

Examples of installation Dimensions	Minimum installation space			
	I	II	III	IV
L1	Open	280	280	180
L2	100	75	Open	Open
L3	100	80	80	80
L4	250	Open	250	Open

## FDC90VNP1

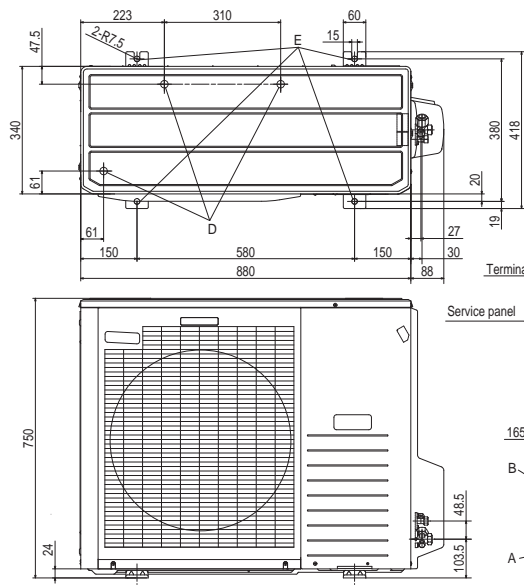

### Notes

- (1) It must not be surrounded by walls on four sides.
- (2) The unit must be fixed with anchor bolts. An anchor bolt must not protrude more than 15mm.
- (3) Where the unit is subjected to strong winds, lay it in such a direction that the blower outlet faces perpendicularly to the dominant wind direction.
- (4) Leave 1m or more space above the unit.
- (5) A wall in front of the blower outlet must not exceed the unit's height.
- (6) The model name label is attached on the lower right corner of the front panel.

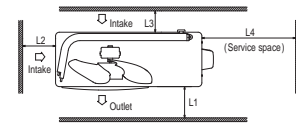

Minimum installation space

Examples of installation Dimensions	Minimum installation space		
	I	II	III
L1	Open	Open	500
L2	300	250	Open
L3	100	150	100
L4	250	250	250

Symbol	Content
A	Service valve connection (gas side) $\phi 15.88(5/8)$ ( Flare)
B	Service valve connection (liquid side) $\phi 9.52(3/8)$ ( Flare)
C	Pipe/cable draw-out hole
D	Drain discharge hole $\phi 20 \times 3$ places
E	Anchor bolt hole M10 x 4 places

## FDC100VNP

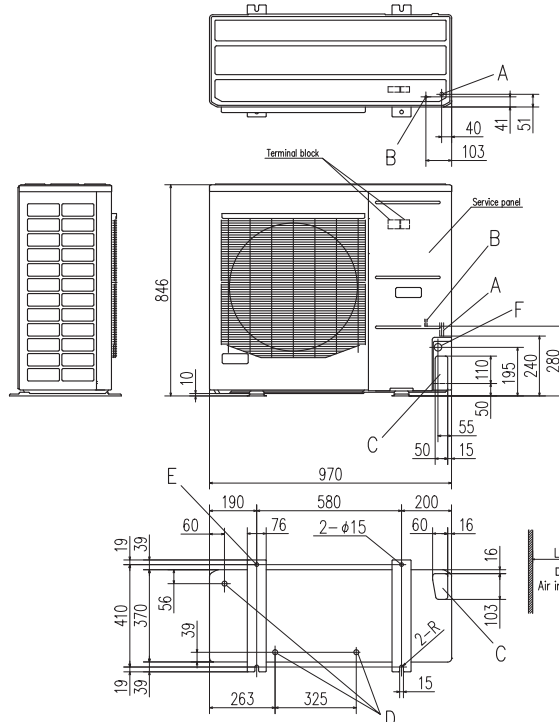

Symbol	Content
A	Service valve connection (gas side) $\phi 15.88(5/8)$ ( Flare)
B	Service valve connection (liquid side) $\phi 9.52(3/8)$ ( Flare)
C	Pipe/cable draw-out hole
D	Drain discharge hole $\phi 20 \times 3$ places
E	Anchor bolt hole M10x 4 places
F	Cable draw-out hole $\phi 30 \times 3$ places

### Notes

- (1) It must not be surrounded by walls on the four sides.
- (2) The unit must be fixed with anchor bolts. An anchor bolt must not protrude more than 15mm.
- (3) Where the unit is subject to strong winds, lay it in such a direction that the blower outlet face is perpendicular to the dominant wind direction.
- (4) Leave 1m or more space above the unit.
- (5) A wall in front of the blower outlet must not exceed the units height.
- (6) The model name label is attached on the service panel.

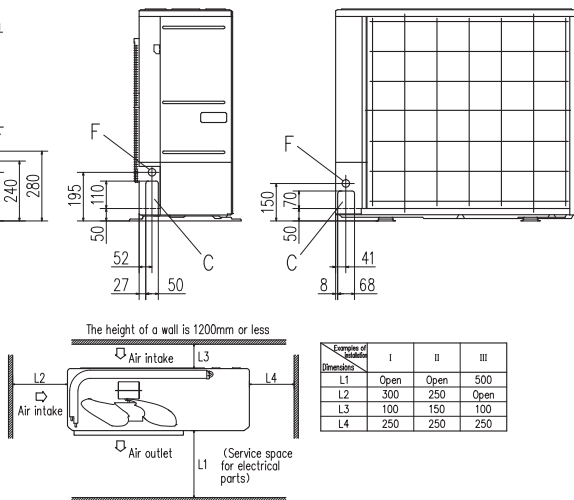

Minimum installation space

Examples of installation Dimensions	Minimum installation space		
	I	II	III
L1	Open	Open	500
L2	300	250	Open
L3	100	150	100
L4	250	250	250

## Before starting use

### Heating performance

The heating performance values (kW) described in the catalogue are the values obtained by operating at an outdoor temperature of 7°C and indoor temperature of 20°C as set forth in the ISO Standards. As the heating performance decreases the outdoor temperature drops, if the outdoor temperature is too low and the heating performance is insufficient, use other heating appliances as well.

### Indication of sound values

The sound values are the values (A scale) measured in a chamber such as an anechoic chamber following the ISO Standards. In the actual installation state, the value is normally larger than the values given in the catalog due to the effect of surrounding noise and echo. Take this into consideration when installing.

### Use in oil atmosphere

Avoid installing this unit in an atmosphere where oil scatters or builds up, such as in a kitchen or machine factory. If the oil adheres to the heat exchanger, the heat exchanging performance will drop, mist may be generated, and the synthetic resin parts may deform and break.

### Use in acidic or alkaline atmosphere

If this unit is used in acidic atmosphere such as hot spring areas having high level of sulfuric gases or in alkaline atmosphere including ammonia or calcium chloride, places where the exhaust of the heat exchanger is sucked in, or at coastal areas where the unit is subject to salt breezes, the outer plate or heat exchanger, etc., will corrode. Please ask a dealer or specialist when you use an air conditioner in places differing from a general atmosphere.

### Use in places with high ceilings

If the ceiling is high, install a circulator to improve the heat and air flow distribution when heating.

### Refrigerant leakage

The refrigerant (R32,R410A) used for Air conditioner is non-toxic and inflammable in its original state.

However, in consideration of a state where the refrigerant leaks into the room, measures against refrigerant leaks must be taken in small rooms where the tolerable level could be exceeded. Take measures by installing ventilation devices, etc.

### Use in snowy areas

Take the following measures when installing the outdoor unit in snowy areas.

#### •Snow prevention

Install a snow-prevention hood so that the snow does not obstruct the air intake port or enter and freeze in the outdoor unit.

#### •Snow piling

In areas with heavy snow fall, the piled snow could block the air intake port. In this case, a frame that is 50cm or higher than the estimated snow fall must be installed underneath the outdoor unit.

### Automatic defrosting device

If the temperature is low, and the humidity is high, frost will stick to the heat exchanger of the outdoor unit. If use is continued, the heating performance will drop.

The "Automatic defrosting device" will function to remove this frost. After heating for approx. three to ten minutes, it will stop, and the frost will be removed. After defrosting, hot air will be blown again.

### Servicing the air-conditioner

After the air-conditioner is used for several seasons, dirt will build up in the air-conditioner causing the performance to drop. In addition to regular servicing, we recommend the maintenance contract (charged for) by a specialist.

## Safety Precautions

### Air-conditioner usage target

The air-conditioner described in this catalog is a dedicated cooling/heating device for human use.

Do not use it for special applications such as the storage of food items, animals or plants, precision devices or valuable art, etc.

This could cause the quality of the items to drop, etc.

Do not use this for cooling vehicles or ships. Water leakage or current leaks could occur.

### Before use

Always read the "User's Manual" thoroughly before starting use.

### Installation

Always commission the installation to a dealer or specialist. Improper installation will lead to water leakage, electric shocks and fires.

Make sure that the outdoor unit is stable in installation. Fix the unit to stable base.

### Usage place

Do not install in places where combustible gas could leak or where there are sparks. Installation in a place where combustible gas could be generated, flow or accumulate, or places containing carbon fibers could lead to fires.

## Mitsubishi Heavy Industries Thermal Systems, Ltd.

(Wholly-owned subsidiary of MITSUBISHI HEAVY INDUSTRIES, LTD.)

16-5, Konan 2-chome, Minato-ku, Tokyo, 108-8215 Japan

<https://www.mhi-mth.co.jp/en/>

Our factories are ISO9001 and ISO14001 certified.

#### Certified ISO 9001



Certificate Number : JQA-0709



Certificate:44 100 980813



Certificate Number : 4333-2007-AQ-RGC-RvA

#### Certified ISO 14001



Certificate Number : YKA4005636



Certificate:04 104 980813



Certificate number : 02117E10160R0M

